

newline

Collaboration Touch Screen User Manual



ER Series

V1.0

Please keep this Manual properly for future reference!

This manual is a general manual, the pictures are for reference only, Please refer to the real product.

Contents

Contents	I
Symbol Convention.....	1
Safety Instructions	2
1 Product Overview	6
1.1 Product Introduction	6
1.2 Parts	7
1.3 Ports	9
1.3.1 Front Ports.....	9
1.3.2 Rear ports.....	11
1.4 Front Buttons.....	14
1.5 Remote Control	15
1.5.1 Remote Control Buttons.....	15
1.5.2 Range of Remote Control	18
2 Installation Guide	19
2.1 Safety Precautions	19
2.2 Installation Precautions	20
2.3 Ventilation	21
2.4 OPS Computer Installation	22
3 Power On /Off.....	24
3.1 Power On.....	24
3.2 Power Off	24
4 Operating the Touch Screen	27
4.1 Home	27
4.2 OPS Computer	31
4.3 Sources	32
4.4 Whiteboard	33
4.4.1 Page Operations	35
4.4.2 Whiteboard Setting.....	36
4.5 Annotation	37
4.6 Tutorial	39
4.7 Floating bar	39
4.8 Gadget	42
4.8.1 Newline Cast	43
4.8.2 File Commander	44

4.9 System Settings	47
4.9.1 Network Settings.....	48
4.9.2 Language and Input.....	49
4.9.3 Date and Time Settings	50
4.9.4 Storage	52
4.9.5 Applications.....	53
4.9.6 Display & Theme	53
4.9.7 Tool bar.....	54
4.9.8 Input and Output Setting	55
4.9.9 Power ON/OFF Setting	55
4.9.10 Security Setting	58
4.9.11 Smart Eye Protection.....	58
4.9.12 System	59
4.10 Save session.....	59
4.11 Automatically End Session	62
5 Add Shortcut.....	63
5.1 Add Shortcuts to Dock.....	63
5.2 Delete shortcuts to Dock	64
5.3 Newline Assistant	65
5.3.1 Introduction	65
5.3.2 Installation.....	65
5.3.3 Add Quick Start Windows Programs in Smart System	65
6 Quick Setting Menu	67
7 D. Mode.....	70
8 Serial Port Control	71
9 VGA Signal Input Specifications	78
10 Formats Supported by Multi-media.....	79
11 Troubleshooting.....	80
12 Maintenance.....	83
13 Technical Parameter	84



Thank you for choosing Newline collaboration touch screen.

The symbol of the crossed out wheeled bin indicates this product should not be placed in municipal waste. Instead, dispose of waste equipment by handing it over to a designated collection point for the recycling of electrical and electronic equipment.







Symbol Convention





Symbols are used in this document to indicate operations that require special attention. The symbols are defined as follows:



 WARNING	Indicates a hazard with risk that, if not avoided, could result in death or injury.
 CAUTION	Indicates a potentially hazardous situation that, if not avoided, could result in equipment damage, data loss, performance deterioration, or unanticipated results.
 NOTE	Provides additional information to supplement operation in the main text.



Safety Instructions

For your safety, please read the following instructions before you use the product. Improper operations may cause severe injury or property damage. Please refrain from repairing the product on your own.

 WARNING	
	<p>If major failures occur, disconnect the product from power source immediately. Major failures include the following:</p> <ul style="list-style-type: none"> • Smoke, peculiar smell or abnormal sound discharged from the product. • No image or sound is displayed, or if image error occurs. <p>If the above scenarios occur, do not continue using the product. Disconnect power supply immediately and contact professional staff.</p>
	<p>Do not drop liquid, metal or anything combustible into the product.</p> <ul style="list-style-type: none"> • If liquid or pieces of metal get into the product, turn off the power and disconnect the power source, then contact professional staff. • Supervise children when they are close to the product.
	<p>Place the product on a stable surface. An unstable surface includes but is not limited to an inclined surface, a shaky stand, desk or platform, which might cause turnover and damage.</p>
	<p>Do not open the cover or modify the product on your own. High voltage components are installed in the product. When you open the cover, high voltage, electric shock, or other dangerous situations may occur. If inspection, adjustment, or maintenance is required, contact the local distributor for help.</p>
	<p>Use the specified power supply voltage.</p> <ul style="list-style-type: none"> • To prevent the product from being damaged, do not use cables other than the one provided with the product. • Use a three-wire socket and ensure that it is properly grounded. • Pull out the power plug from the socket if the product is not to be used for a long period.
	<p>Regularly clean the dust and metal around the power plug.</p> <ul style="list-style-type: none"> • Fire or electric shock may be caused if the product is powered on, when you are cleaning. • Pull out the power plug before cleaning it with a dried cloth.

 WARNING	
	<p>Do not place items on top of the product.</p> <ul style="list-style-type: none"> Do not put items, such as a liquid container (a vase, flowerpot, cosmetics or liquid medicine) on the top of the product. If any water or liquid is spilled on the product, a short circuit may occur and cause fire or electric shock. Do not walk on or hang any items on the product.
	<p>Do not install the product in an improper place.</p> <ul style="list-style-type: none"> Do not install the product in humid places, such as the bathroom, the shower room, near windows, or outdoor environments that experience rain, snow or other harsh weather. Avoid installation near hot spring vapor. The preceding environments may cause faults in the product or electric shock under extreme conditions. Do not put expose the product to a fire source, such as an ignited candle.
	<p>Pull out the power plug during thunderstorms.</p> <ul style="list-style-type: none"> Do not touch the product during a lighting storm to avoid electric shocks. Install or place components that supply high enough voltage out of the reach of children.
	<p>Do not touch the power cable with wet hands.</p>

 CAUTION	
	<p>Do not install the product in high temperature environments.</p> <ul style="list-style-type: none"> Do not install the product near a heat source, such as a radiator, a heat reservoir, a stove or other heating products. Do not expose the product to direct sunlight, which may cause high temperatures and subsequent faults in the product.
	<p>Transport of the product.</p> <ul style="list-style-type: none"> Pack the product for transport or maintenance by using the cartons and cushioning material provided with the product. Keep the product vertical during transport. The screen or other components are easily broken if the product is moved inappropriately. Before you move the product, disconnect all external connections and separate all toppling preventing products. Move the product carefully to prevent it from being hit or squeezed, especially the screen, which may cause injury if broken.

	<p>Do not cover or block up any vents on the product. Any overheated components may cause fire, damage the product, and shorten the product's service life.</p> <ul style="list-style-type: none"> • Do not lay the product down where the venting surface will be covered. • Do not install the product on a carpet or cloth. • Do not use a cloth such as table cloth to cover the product.
	<p>Keep away from the product when using a radio.</p> <p>The product complies with the international EMI standard regarding prevention of radio interference. However, interference may still exist and cause noises to the radio. If noise occurs in the radio, try the following solutions.</p> <ul style="list-style-type: none"> • Adjust the direction of the radio antenna to avoid the interference from the product. • Keep the radio away from the product. <p>If the screen glass is broken or falls off.</p> <ul style="list-style-type: none"> • Keep all personnel 10 feet away from the screen to ensure safety. • Do not perform any installation or disassembly while the screen glass is broken or has fallen off. <p>Do not damage the power cable.</p> <ul style="list-style-type: none"> • Do not damage, change, twist, bend, or forcibly drag the power cable. • Do not put weights (such as the product itself) on top of the power cable. • Do not forcibly drag the cable when you pull out the power plug. If the power cable is damaged, please contact the local distributor to repair or replace it. • The power cable in the accessory box is for this product only. Do not use it on other products. <p>Correct battery usage.</p> <ul style="list-style-type: none"> • Galvanic corrosion, electric leakage, and even fire may be caused by improper battery usage. • It is recommended to use the designated type of battery and install the battery by correct electrodes (positive and negative). • Do not use a new battery alongside a used one. • Take out the batteries if the remote control is not to be used for a long period. • Do not expose the batteries to overheated environments such as sunlight and firing. • Dispose of used batteries based on your local regulations. <p>Suggestions for usage:</p> <ul style="list-style-type: none"> • Use the product in an environment with comfortable lighting. It is harmful to your eyes to watch in a too bright or too dark environment. • Rest your eyes after an extended period of usage. • Keep sufficient distance from the product to protect your eyes and prevent eyestrain. • Adjust the volume to an appropriate level, especially at night. • Use amplifier equipment as the audio input source with caution. If you must use amplifier equipment, the input power should not exceed the maximum of speaker power. Otherwise, the speaker can become overpowered and damaged. <p>About USB port.</p> <p>Front USB ports and rear USB 3.0/USB 2.0 ports switch connections based on signal sources. If</p>

	<p>the current signal source is reading the data from an external product connecting to the port, please switch the signal source after the data reading is complete. Otherwise, the data or product may be damaged.</p>
	<p>Special Notes:</p> <ul style="list-style-type: none">• Under the premise of ensuring the display quality, the energy consumption can be reduced by reducing the brightness of the display.• This product can be paired with various OPS Computers, which can be upgraded or replaced according to your needs.

1 Product Overview

1.1 Product Introduction

This machine is a multi-functional device that integrates interactive conference, digital presentation, multimedia presentation, touch operation and handwriting input. From design to production, we have fully considered the application characteristics of business conferences to ensure easy and intuitive operation. Through full digital intelligent control, it allows writing, editing and deleting on the screen using fingers, Smooth pen or opaque objects. It is an ideal product for modern conferences.

Features:

- Advanced infrared array scanning sensing technology achieves superior positioning capability and precise tracking; zooming in and out, free dragging, roaming via fingers, area erasure, all in a touch.
- High-brightness, high-contrast screen, clear and visible under strong light, indoors or outdoors.
- UHD resolution, high-power stereo, clear and smooth picture, stereo surround sound, Hi-Fi live sound, theater-level audio-visual pleasure.

1.2 Parts

Front view

65/75/86 inch:



Rear view

65/75/86 inch:

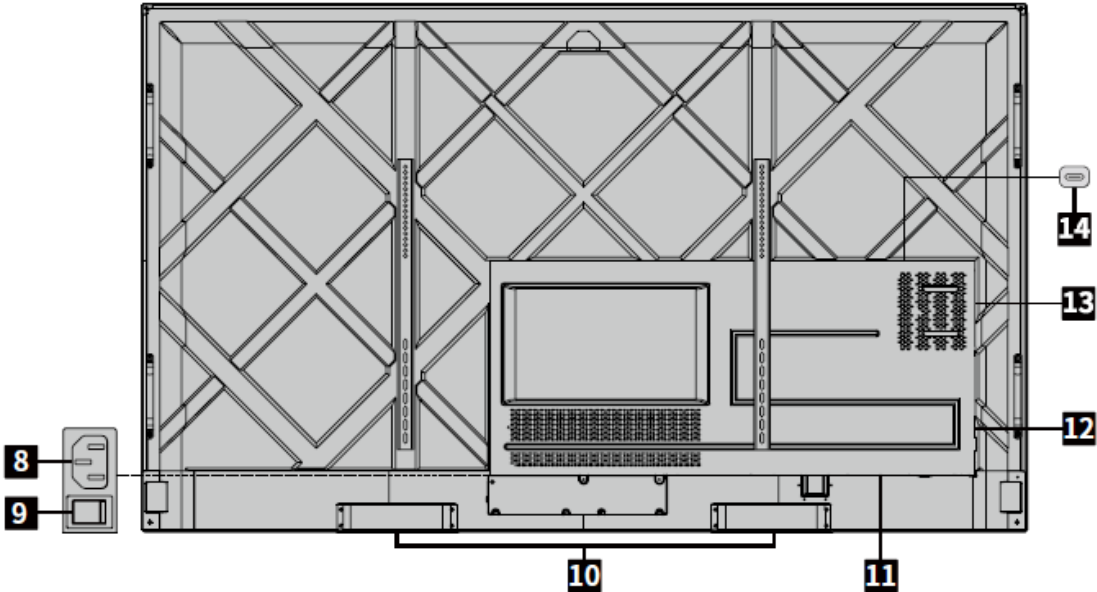

1	Touch screen	8	Power socket
2	Power button	9	Power switch
3	Front button for volume control	10	Speaker
4	IR receiver	11	Rear ports 1
5	Light sensor	12	Rear ports 2
6	Front ports	13	OPS Computer slot
7	Microphone	14	SoundBar port

1.3 Ports

1.3.1 Front Ports

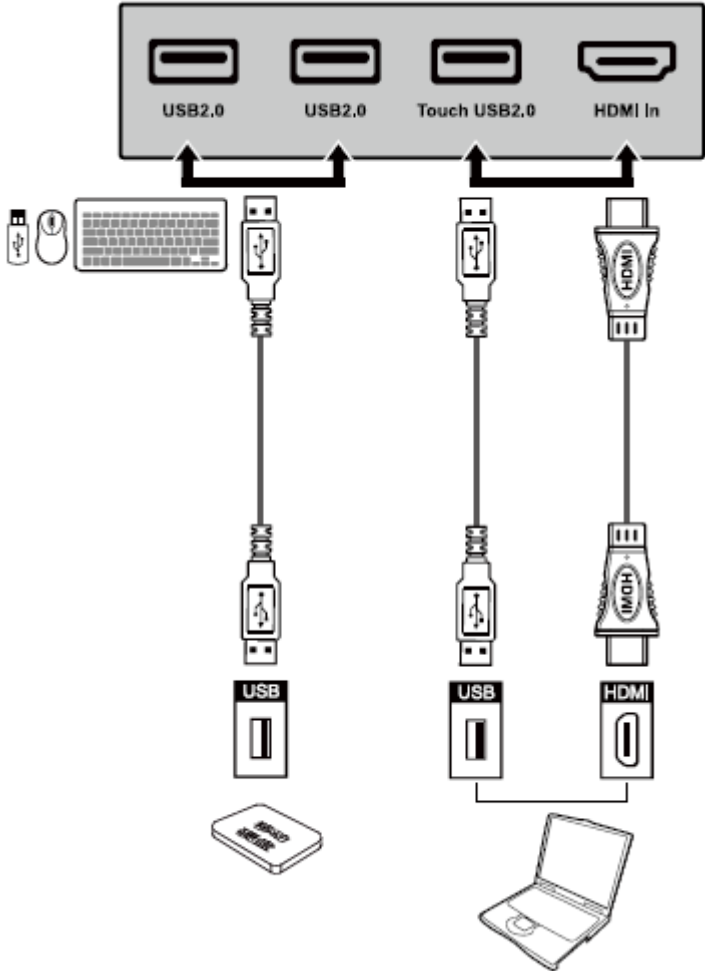

Name	Function description
USB 2.0	<p>Connect to USB devices such as mobile hard disk, USB flash drive, USB keyboard and mouse.</p> <p>Notes:</p> <p>Users can enter “Setting > Input and output > USB connection” to choose the system (OPS or Smart system) for USB port.</p> <p>If users choose the public, when the interface is Smart system, the device on the USB is used by Smart system. When it switches to OPS, the USB device is connected to OPS.</p>
Touch USB 2.0	Connect to the touch port of your PC.

HDMI IN	HDMI signal input port. Used in combination with “Touch USB 2.0” to operate the PC via touchscreen technology.
---------	---

1.3.2 Rear ports

WARNING

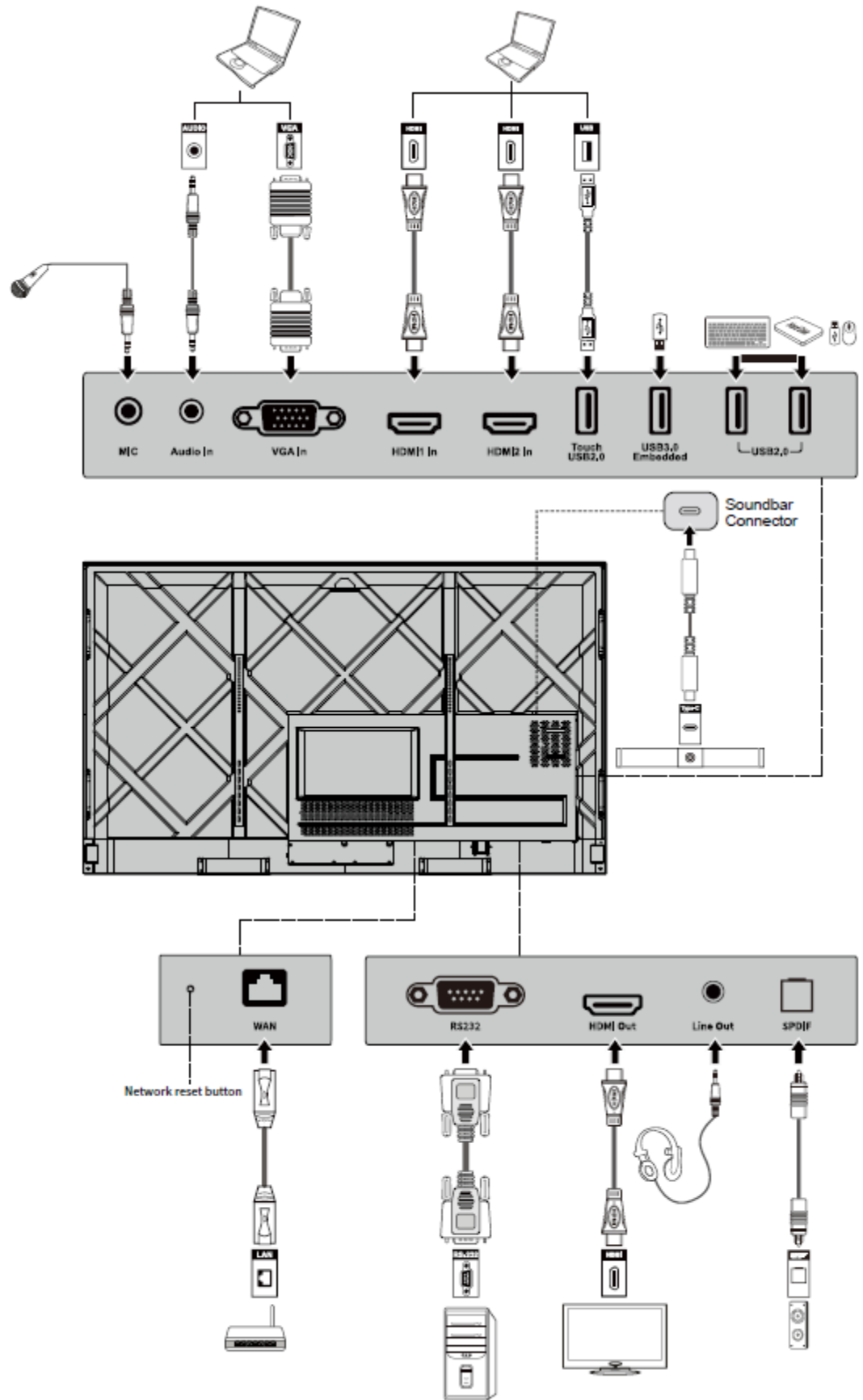

- Front USB 2.0 ports and rear USB 3.0/USB 2.0 ports switch connections based on signal sources. If the current signal source is reading the data from an external storage connecting to the port, please switch the signal source after the data reading is complete. Otherwise, the data or product may be damaged.
 - USB2.0/USB3.0 ports output: 5V/500mA (Max.). For qualified device use only otherwise may cause electrical shock or fire.
 - Soundbar Connecting port output: 18V/3A. Soundbar connecting port may only use for TS-series Soundbar. The manufacture cannot be responsible for the possible damage caused by connecting to other devices.
-

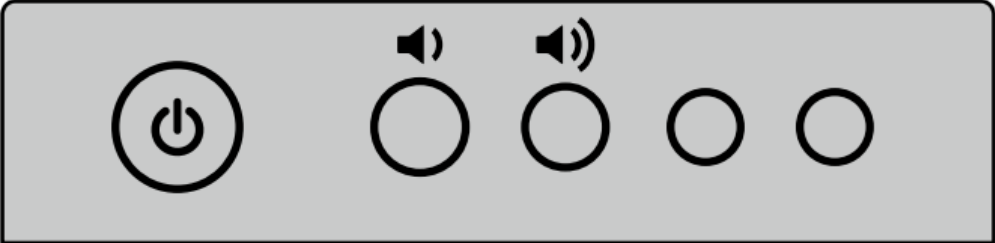

Name	Function description
MIC	Microphone input port
Audio In	Audio input port, used in combination with “VGA In”.
VGA In	VGA signal input port. Used in combination with “Touch USB 2.0” to operate the PC in touch mode.
HDMI 1 In	HDMI signal input port 1. Used in combination with “Touch USB 2.0” to operate the PC in touch mode.
HDMI 2 In	HDMI signal input port 2. Used in combination with “Touch USB 2.0” to operate the PC in touch mode.
Touch USB 2.0	Connect to the touch port of your PC.
USB 3.0 Embedded	For local playback and system upgrade
USB 2.0	Connect to USB devices such as mobile hard disk, USB flash drive, USB keyboard and mouse.
WAN	Network interface, connecting to RJ45 terminal
Network reset button	Press the reset button for 5 seconds with a pinhole object to reset the network settings of the product to default.
RS232	Serial port signal input interface, which allows inputting serial port settings through a specific serial port control device to achieve the purpose of controlling the product.
HDMI Out	Connect to an electronic video device with HDMI input
Line Out	Connect to audio output device such as headphone and speaker.
SPDIF	Digital audio interface, optical output interface. Connect audio equipment with fiber optic input; such as amplifiers, stereos, and speakers.
Soundbar	Connect to TS series Soundbar (optional) Warning: TS Series Soundbar Connector port only use for TS series Soundbar. The manufacture cannot be responsible for the possible damage caused by connecting to other devices.

1.4 Front Buttons



Buttons	Function description
	Power on/off. <ul style="list-style-type: none">• Turn on: press it to turn on the display, the power indicator will turn to green.• Turn off: press it to shut down. The power indicator will turn to red.
	Decrease the Volume
	Increase the Volume

Notes:

Press the power button in the power-on state, the product enter shut down mode by default. Users can enter “Settings > Power >Power option” to set the system to enter power off or sleep mode.

1.5 Remote Control



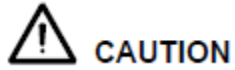

















1.5.1 Remote Control Buttons



To avoid potential malfunctions, please read the following instructions and use the remote control appropriately.

- Do not drop or smack the remote control.
 - Do not spill liquids on the remote control.
 - Do not place the remote control on a wet object.
 - Do not expose the remote control to direct sunlight or other heat sources.
-



Buttons	Functions
	Power on/off.
	Return to home source
External device	Operate the external device(Automatic learning function)
	Up/Down/Left/Right selection button.
	Confirm button.
	Mute or unmute.
	Microphone mute or unmuted.
	Press once to return to the previous page; Press twice to exit the current program. Notes: In the settings page, press once to exit.
	Take a screenshot.
	Freeze the screen. Tap to pause the screen interface and the freeze icon appear on the upper right, Tap again or touch the screen to exit pause.
	Enter/exit Sound Only mode
	Open the task manager
	Open the signal source menu(unavailable in Smart system)
	Increase the brightness
	Decrease the brightness
	Decrease the volume
	Increase the volume
	Switch to the OPS Computer source.
	Enter the external signal source selection page
	Adjust the Backlight mode (ECO>Standard>Auto>Custom)
	Enter the System Settings

1.5.2 Range of Remote Control

Use the remote control within 5 meters in front of the remote-control receiver and at an approximate 30° angle from both sides.

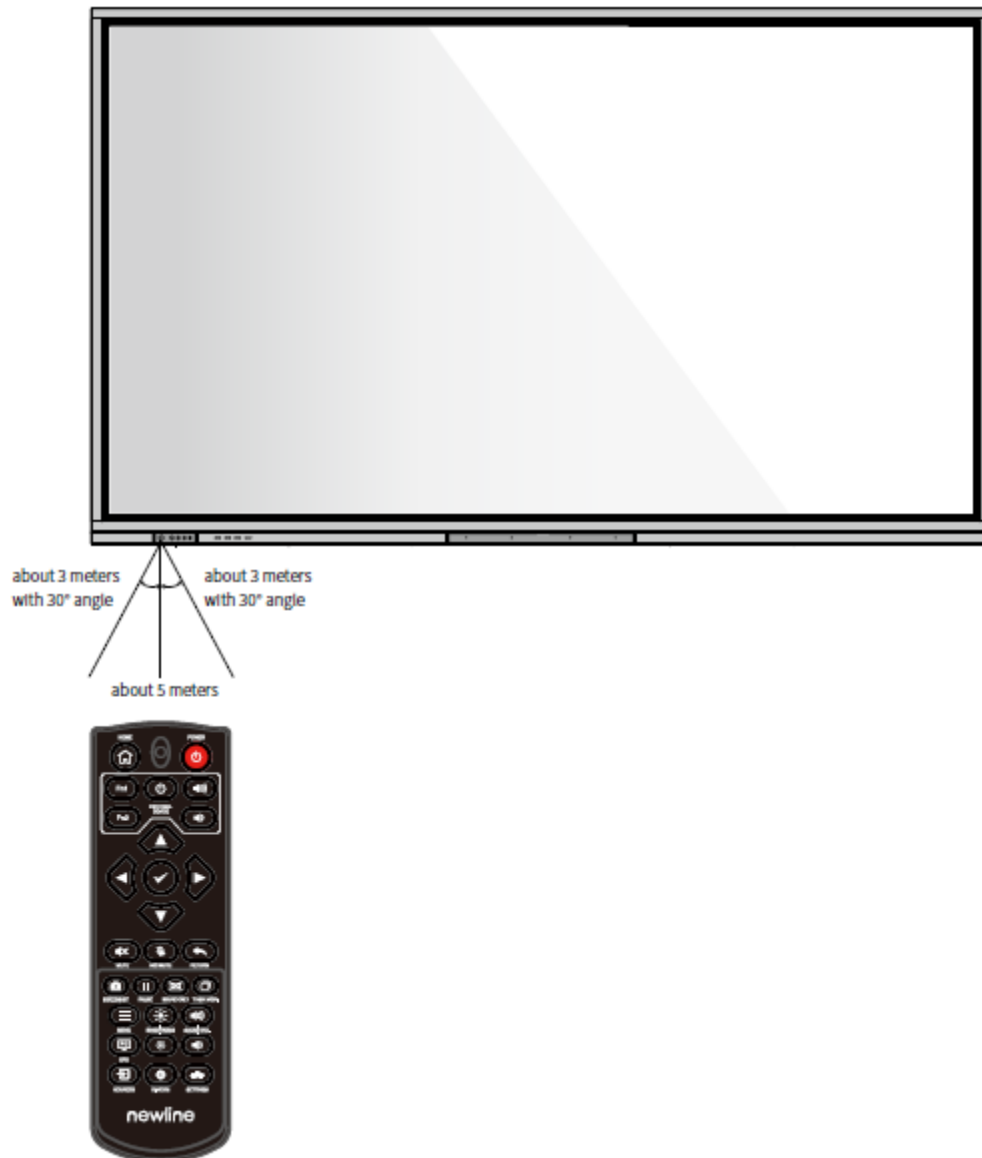

2 Installation Guide

2.1 Safety Precautions

Installation Environment



Installation Direction

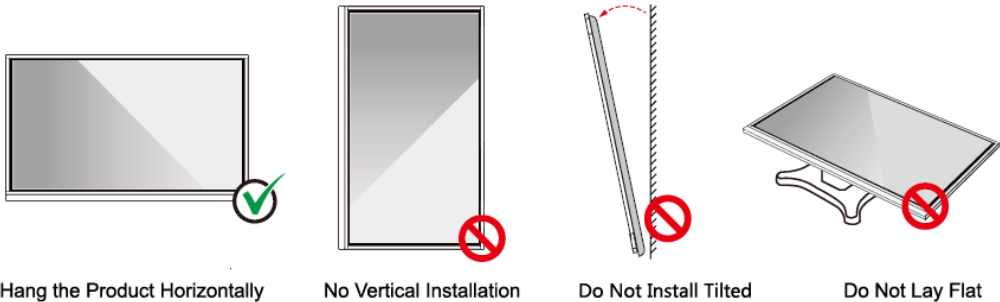

2.2 Installation Precautions

Weight Loading

Net weight of the machine(65",75", 86") : 41kg(±2kg), 55kg(±2kg), 70.5kg(±2kg).

- When using a mobile stand, ensure that the weight of the machine is less than the loading capacity of the mobile stand.
- When using the wall-mount bracket, ensure that the wall can support the weight of the machine. We recommend that the wall surface be reinforced and have a loading capacity 4 times of the weight of the machine. Consult a professional installer for wall-mount installation.

NOTE

- *The company does not undertake relevant legal responsibility for any problems caused by improper operation if the third party mobile stand, or wall-mount bracket is beyond the scope of the machine.*
- *Do not install the machine where it might be hit by an opening or closing door.*

Vertical Installation

When installing, try to keep the machine vertical. An excessive tilt angle may cause the screen glass to fall off or the machine to collapse.

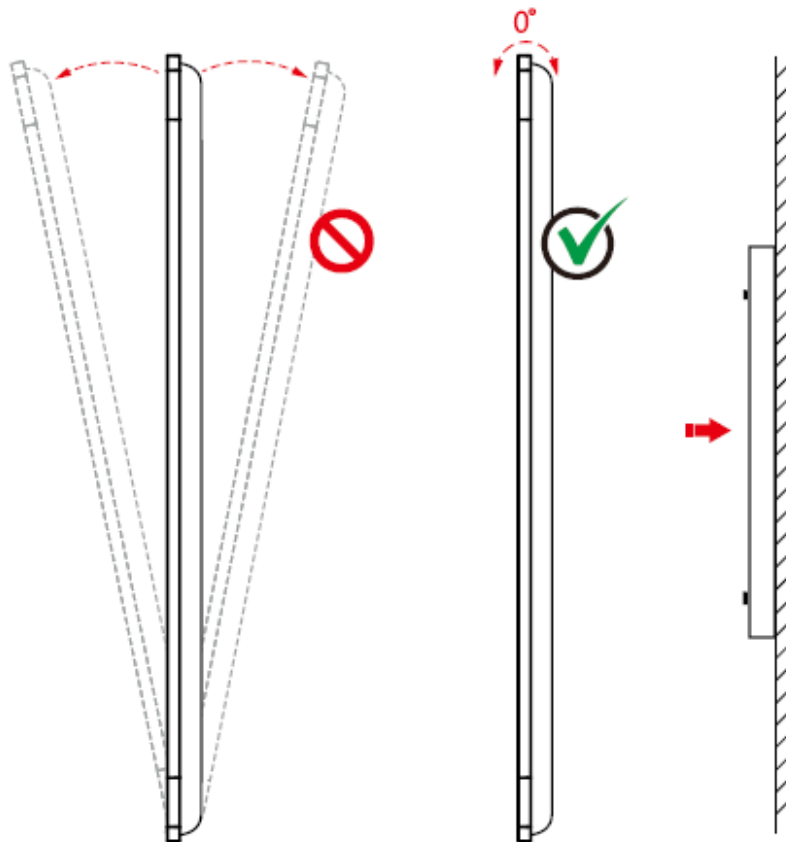

NOTE

- In case of broken glass, all personnel must stand 3 meters away from the machine to ensure safety.
- Do not install or disassemble the machine if the glass is broken.
- For any problem, please contact our support desk. Our company is not responsible for any damage or losses incurred by users if the users fails to follow the instructions.
- Attaching the VESA Mounting Bracket. This apparatus is intended to be supported by a GS Listed wall-mount bracket.

2.3 Ventilation

Distance from mounting surface (mm)			
Left and right sides	Top	Bottom	Rear
100	200	200	100

 **CAUTION**

- In addition to the above requirements, the area of the bottom, side and top vents should not be less than 50% of the sealing area and good air circulation must be maintained when the machine is embedded in the wall and a cabinet.
- For wall mounting, the depth of wall bolts should be greater than 10mm.

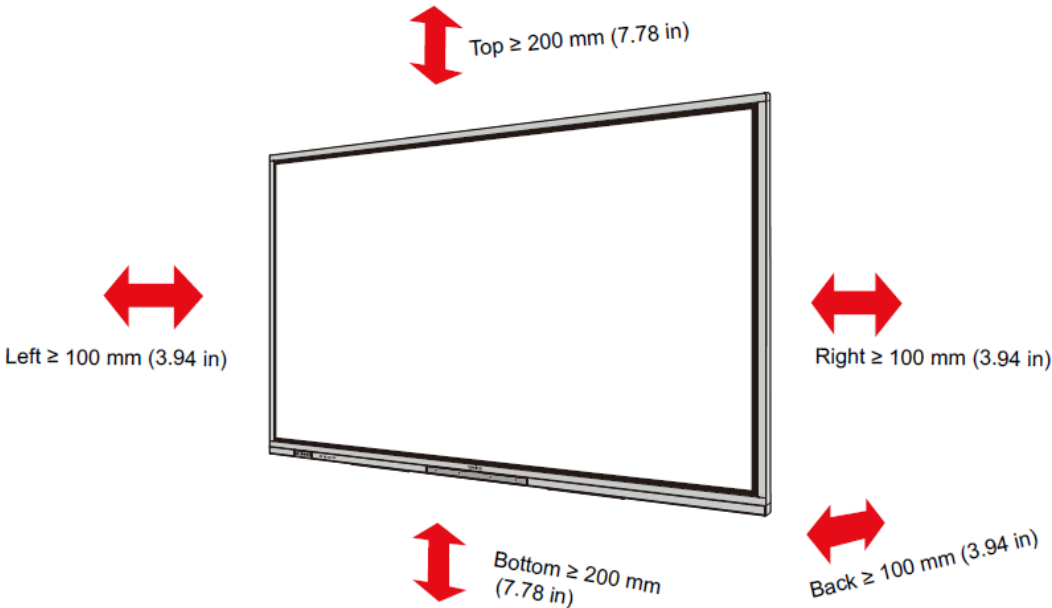

2.4 OPS Computer Installation

WARNING

Do not perform the following on the OPS Computer, or the product may be damaged or end up being unusable!

- Do not plug or unplug the OPS Computer with power connected. Please make sure that the power has been turned off before plugging/unplugging.
 - Do not use the OPS Computer before the screws have been tightened or if any screws are missing.
-

Step 1. (Optional) Unscrew the M3 screws by hand to remove the OPS Computer shielding cover.

Note

This step is optional and suitable for models with the OPS Computer shielding cover.

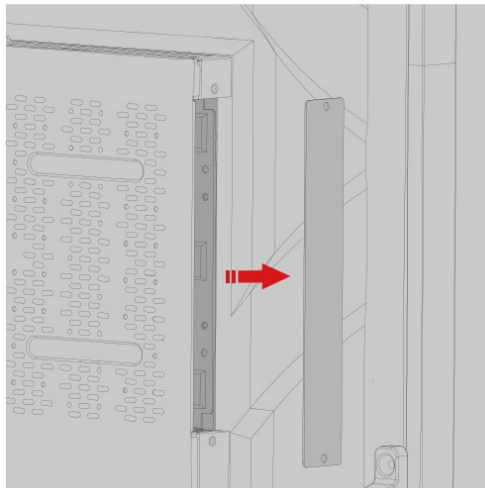

Step 2. Push the OPS Computer horizontally into the interface card slot.

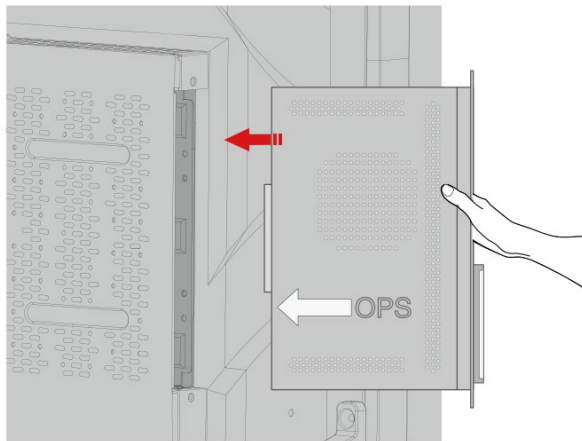

Step 3. Pass the fixing screws through the upper and lower lugs and tighten them.

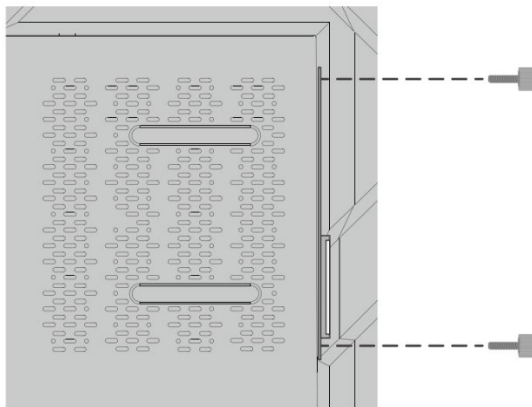

Note

If the screen fuzzes, flashes or if no signal is received from the OPS Computer channel after turning on the power, it means that the OPS Computer has not been properly installed. Please check it and re-install.

3 Power On /Off

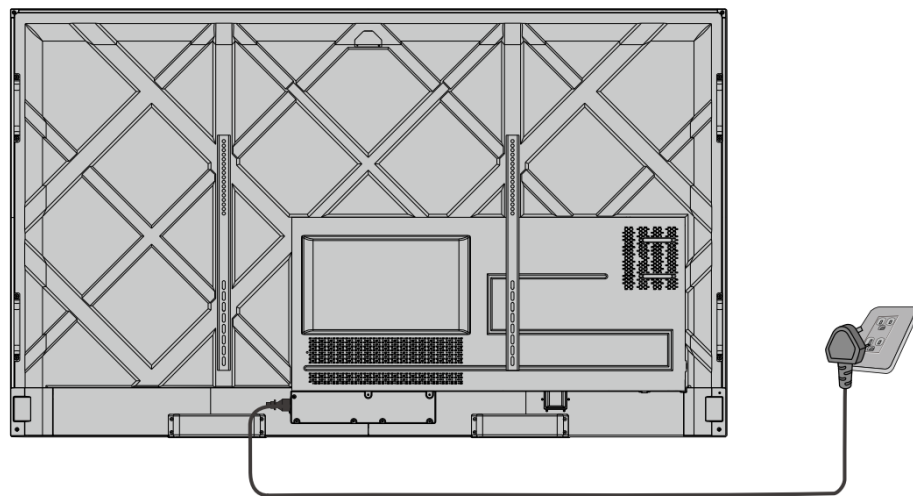

3.1 Power On

Step 1 Use AC power (100V~240V, 50Hz/60Hz) as the machine power source. Make sure the power plug fully inserted and that the ground wire of the outlet is properly connected.



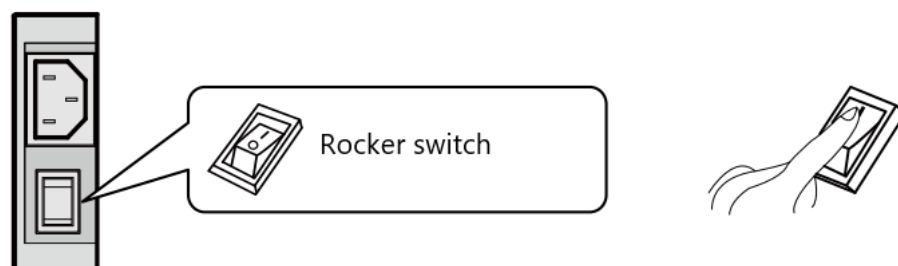

Step 2 Turn on the rocker switch (on the rear side of the machine, next to the power socket) after a power source has been connected. The power indicator should be red.





Step 3 Press the “” button on the front panel or the “” button on the remote control to start the machine (the indicator light turns green).



3.2 Power Off

Step 1. Power off the screen in the following situations:

- If there is no whiteboard data or screenshot(s), press the power button  on the front panel or the power button  on the remote control to power off the screen. Go to Step 4.
- If there is whiteboard data or screenshot(s), store your session documentations before powering off the touch screen. Otherwise, the product will delete your session documentations after the session is complete.

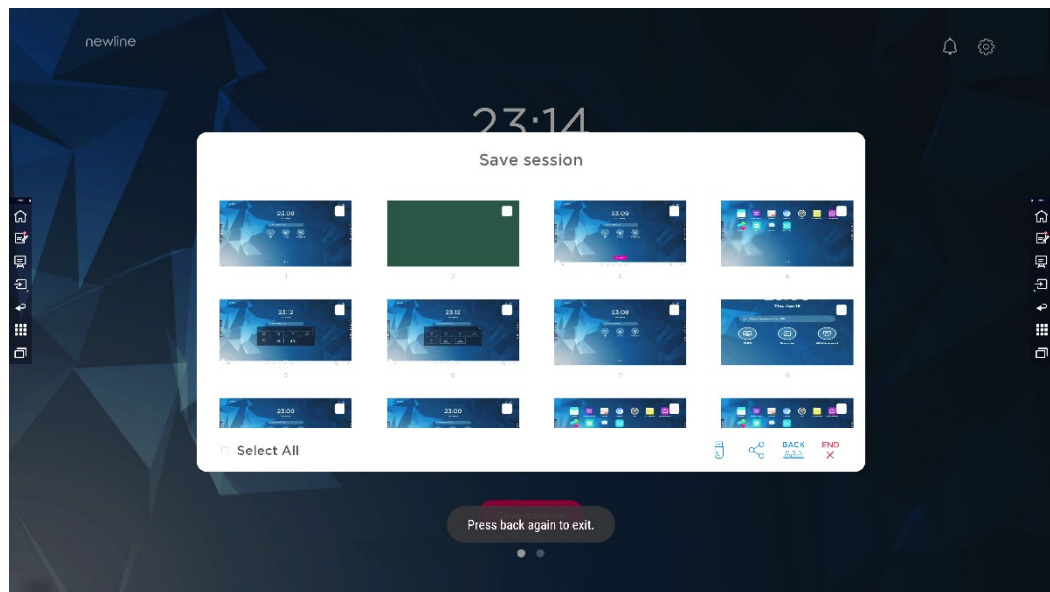
Press the power button  on the front panel or the power button  on the remote control. The **Save session** page will be displayed as shown in the following figure.



Step 2. Press the power button  on the front panel or the power button  on the remote control again. The **Warning** dialog box will be displayed as shown in the following figure.

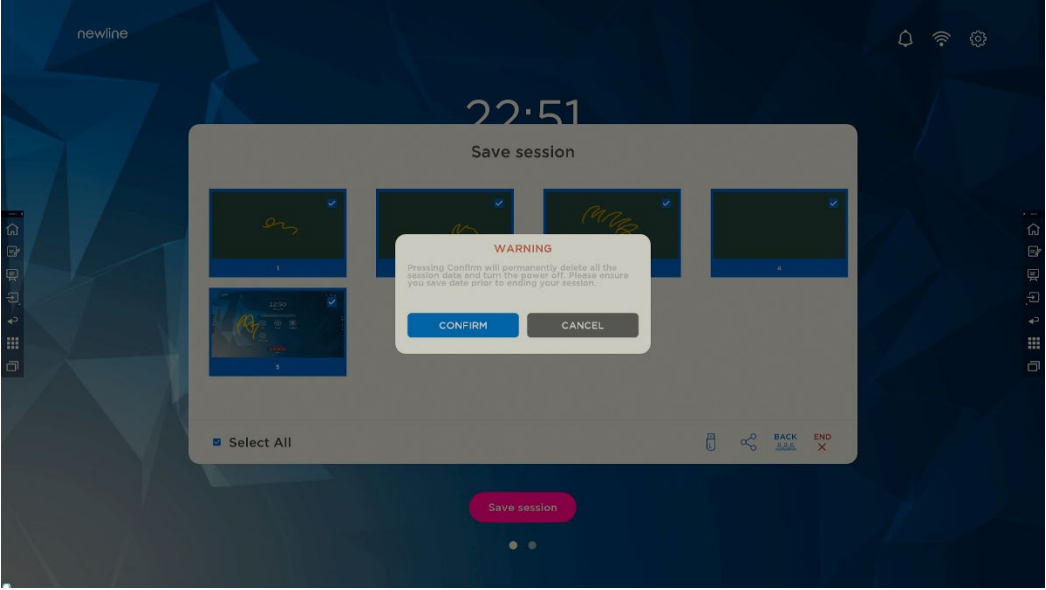

Step 3. In the **Warning** dialog box, Tap **Cancel**. You can save files if desired. After files are saved, return to Step 2. Tap **Confirm**, and the power indicator will turn to red.

Step 4. If you want to completely turn off the product, turn off the rocker switch under the product (next to the power socket) and unplug the power cord.

 **CAUTION**

- When the product enters sleep mode or shutdown, the system will first detect whether the OPS Computer is turned off. If not, it first turns off the computer before it enters sleep mode or shutdown.
- Please shut down the product before disconnecting the power source or it may damage the machine. Accidental power failure may cause damage to the machine.
- Do not repeatedly turn the power on & off in a short period of time as it may cause malfunction.

Indicator	Product status
Off	Shut down or power disconnected
Red	Shutdown
Green	Working state

4 Operating the Touch Screen

4.1 Home

When the product is turned on, the product will show the Home page, as shown in the following figure:

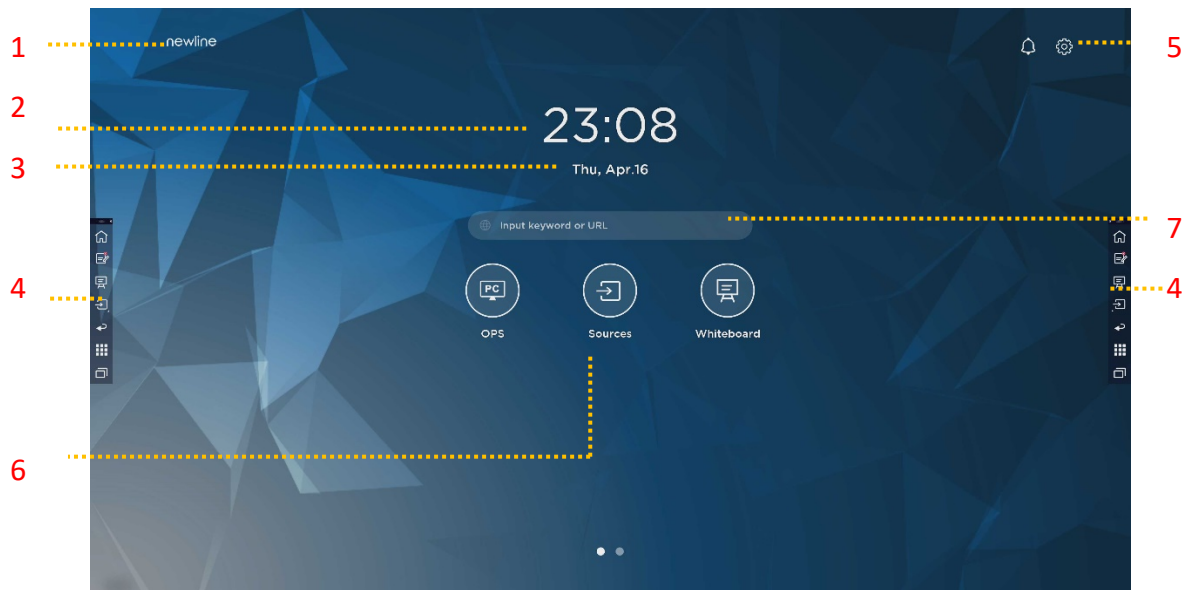









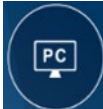

- 1: Logo (Shortcut to Settings) 2: Clock (Shortcut to Clock)
 3: Date and Week(Shortcut to Calendar) 4: Side Toolbar 5: Status Bar and Settings
 6: Main Icon (Dock) 7: Search Bar

Notes:

On the homepage interface, swipe left to switch to the gadget interface. Users can switch the interface between the Home and Gadget by sliding left and right.

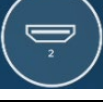
Main Icons

Icons	Functions
	Switch to the OPS Computer source.
	Tap Sources to view the connected sources, including Built-in PC, HDMI Front, HDMI 1, HDMI 2, VGA, Newline cast and Files.
	Whiteboard takes you to the whiteboard function and screen annotation functions.
	Tap “Newline Cast” to enable the wireless screen sharing function.
	Switch to the VGA source
	Tap File viewer to open the File Manager to explore internal and external files on the display.
	Tap Office viewer to open the Office Suite application.
	Switch to the HDMI Front source
	Switch to the HDMI 1 source
	Switch to the HDMI 2 source
	Long press the icons in the dock, you can enter the customization mode. Tap Add to customize the icons or rename it. You can add up to 6 shortcuts to your favorite functions. (See more details in “Add Shortcuts to Home Page”)

Notes:

Users can add or remove main icons as the actual use (OPS, Sources, whiteboard are defaults). More details refer to [5.1 Add Shortcuts to Dock](#).

- **Side Toolbar**

Home, Annotation Mode, Whiteboard, Sources, Return, Gadget and Task manager icons are displayed by default in the sidebar on both sides of the screen. Users can enter "Settings">"Toolbar" to customize the sidebar icon.

You may hide sidebar in the Settings or move it on the screen, shrink or expand by using touch gestures. You may tap the "<" to expand the sidebar. Press the Source icon to unfold level-2 icons.

Shrink



Expand

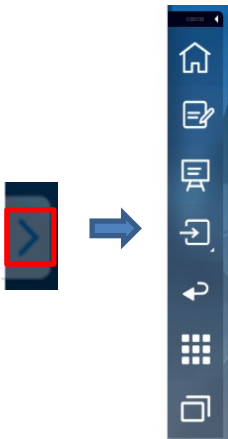

(绘图要求: 增加手势单击)

Unfold level-2 icons

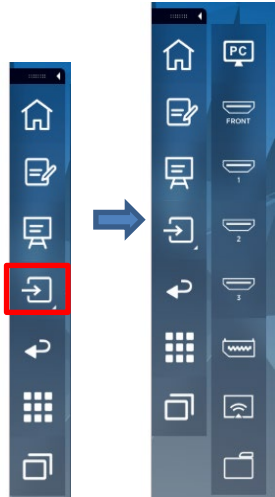

(绘图要求: 增加手势单击)

Sidebar > Floating bar





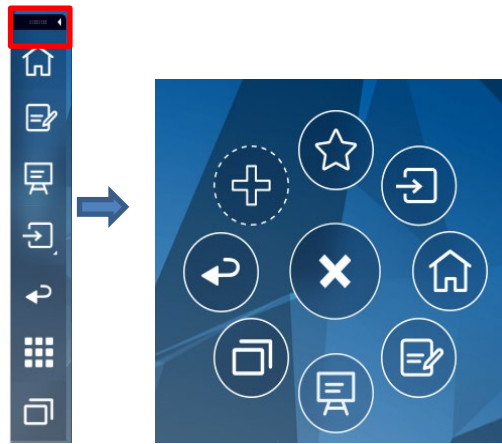

Press the black area above and pulled out, the sidebar can be transformed into a floating bar.

In the floating bar, users can add and delete icons, add custom icons, and drag the floating bar with their fingers to move around on the screen.









(绘图要求: 按住上端的黑色区域往外拉, 可切换成浮动栏。参照 RS,VNX 增加手势效果)

The functions of the sidebar are as follows:

Icons	Functions
	Go to Home page.
	Enter annotation mode, and Tap again to exit annotation mode and take a screenshot.
	Access whiteboard mode.
	Tap to view the external signal sources, including OPS, HDMI Front, HDMI 1 and 2, VGA, Newline Cast and Files.
	Return to the previous menu/Exit an app.
	Enter the Gadgets interface. Gadget displays all pre-installed applications. Tap the icon of an application to run the application.
	Manage currently running applications. Slide left/right the currently running application or Tap “ clear all ” at the upper right corner to clear all the applications.

Status Bar and Settings

The upper right corner of the home page displays working status icons (including USB drive(s), Ethernet, and Wi-Fi), Notification and system setting shortcut.

Icons	Functions
	Tap to enter the Notification page (Show red dots when there is a new notification) .
	If USB drive is connected to the USB port, this icon will appear.
	If the product is connected to Ethernet, the icon will appear.
	If the product is connected to a wireless network, the icon will appear.
	Access the system setting page.
	The icon will appear when the product enter Freezing mode.

4.2 OPS Computer

On the **Home** page, Tap **OPS** to enter the Internal PC source page, as shown in the following figure. If the screen is not equipped with an internal PC, "**No Signal**" is displayed.



On the signal source interface, Tap the **Menu** button on the remote control to enter the signal source menu interface, and the user can make image settings and display settings, as shown in the following figure:

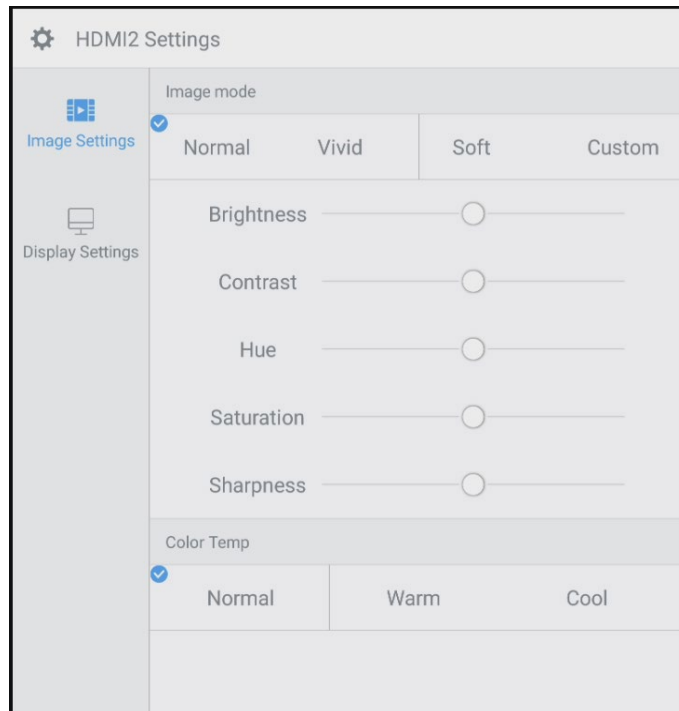



4.3 Sources

On the **Home** page, Tap **Source** to enter the signal sources, including HDMI 1, HDMI 2, VGA, HDMI Front, OPS, File Viewer and Newline Cast.

The icon without signal source connected is gray, and the icon with signal source connected is white. After you choose white icon, the content of the signal source can be displayed in the preview window for real-time preview.

You can enter sources interface by the following methods:

- Tap the **Source** icon on the dock;
- Tap the  icon on the toolbar;
- Tap the  icon on the remote control.

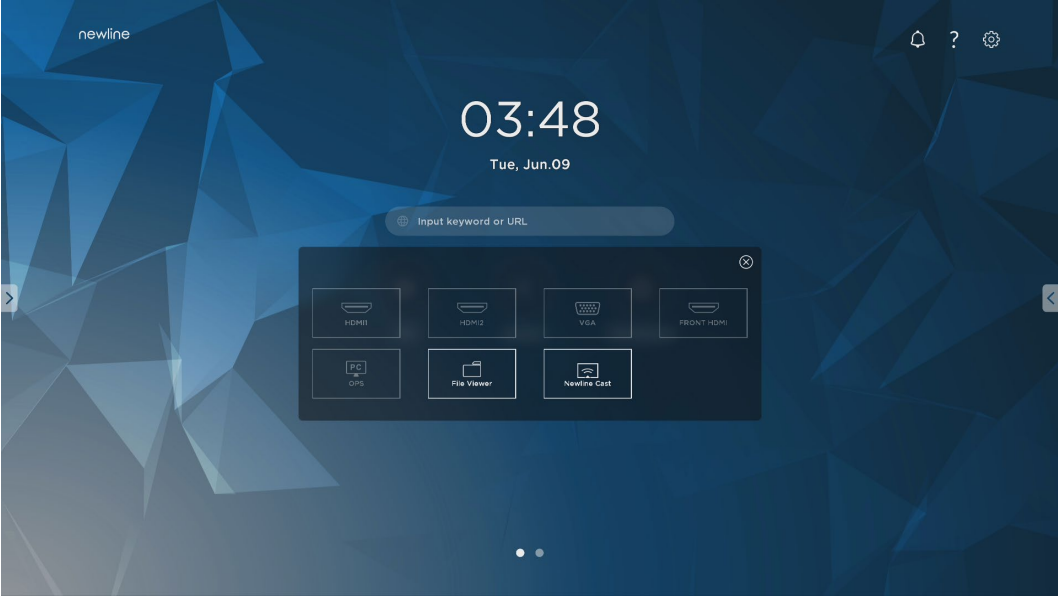









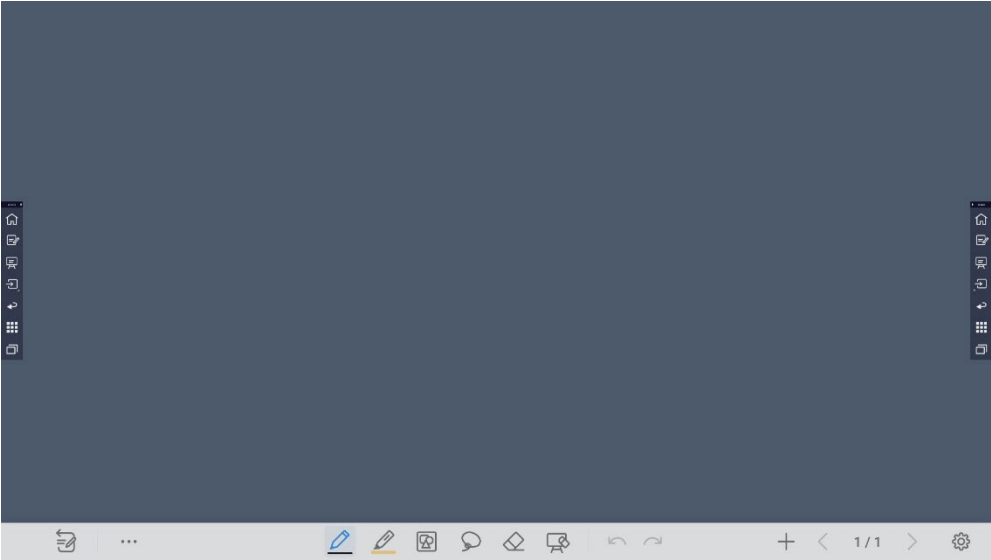







4.4 Whiteboard

The whiteboard function is designed to present conference writing to attendees in a quick and easy manner. Users can write, draw and take screenshots on the whiteboard page.



Tap the icon in the home page or toolbar to enter the whiteboard interface, as shown in the following figure:



Icons	Name	Functions
	Annotation	Tap the icon to switch to the annotation function.
	More	Tap the icon to enter options interface. Users can Insert image, Text, Sticky note, Search Image or Search Web etc.
	Smooth Pen	Tap to use the Smooth Pen function, and the icon turns into blue. Tap and hold the icon for two seconds to set the size and color.
	Highlighter	Tap to use the highlighter function, and the icon will turn blue. Tap and hold the icon for two seconds to set the highlighter size or color.
	Eraser	Tap the icon to erase whiteboard content. Tap the icon again to select the eraser size.
	Insert Auto shape	Tap the icon to enter the auto shape selection interface. Users can insert the shapes and set the shapes color.
	Select	Tap the icon to select and edit the whiteboard content. When the object is selected, users can move, zoom in/out, copy, cut, rotate, lock, change layer or delete object.
	Clear all	Tap the icon to clear all the whiteboard content.
	Undo	Tap the icon to return to the previous step.
	Redo	Tap the icon to restore the action that was cancelled in the previous step.
	New	Tap the icon to create a new whiteboard page.
	Browse	Tap the icon to view all the whiteboard files, and select or delete whiteboard files.
	Previous	Tap to enter the previous page.
	Next	Tap to enter the next page.
	Settings	Tap the icon to enter the Setting interface.

4.4.1 Page Operations

You can preview, select, and delete the writing page, you also can save the page to you USB Flash device or local files.

Page Preview

Tap **1 / 1** at the lower right corner in the whiteboard mode. All pages will be displayed. Tap one page to switch to that page for more operations, as shown in the following figure.





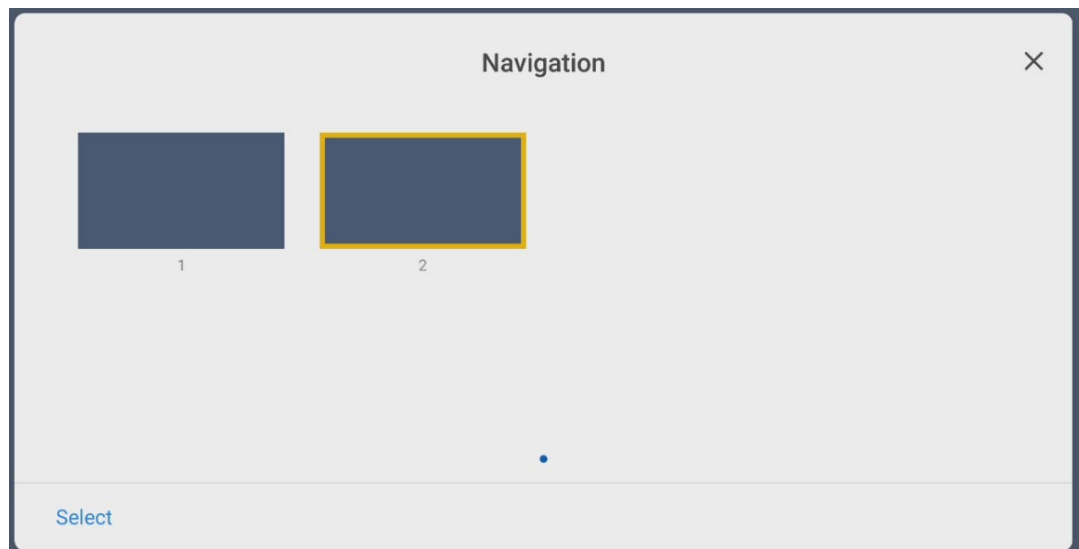

NOTE

Only 8 pages are displayed at once, and you can slide up or down by one finger to see more.



Page Operation

On the **Navigation** page, you can select or delete writing pages according to requirements, as shown in the following figure:

- Tap  to select all pages.
- Tap  to save the writing pages to USB flash device.
- Tap  to share the writing pages to local file or AquaMail.
- Tap  to copy the page.
- Tap  to delete selected pages.

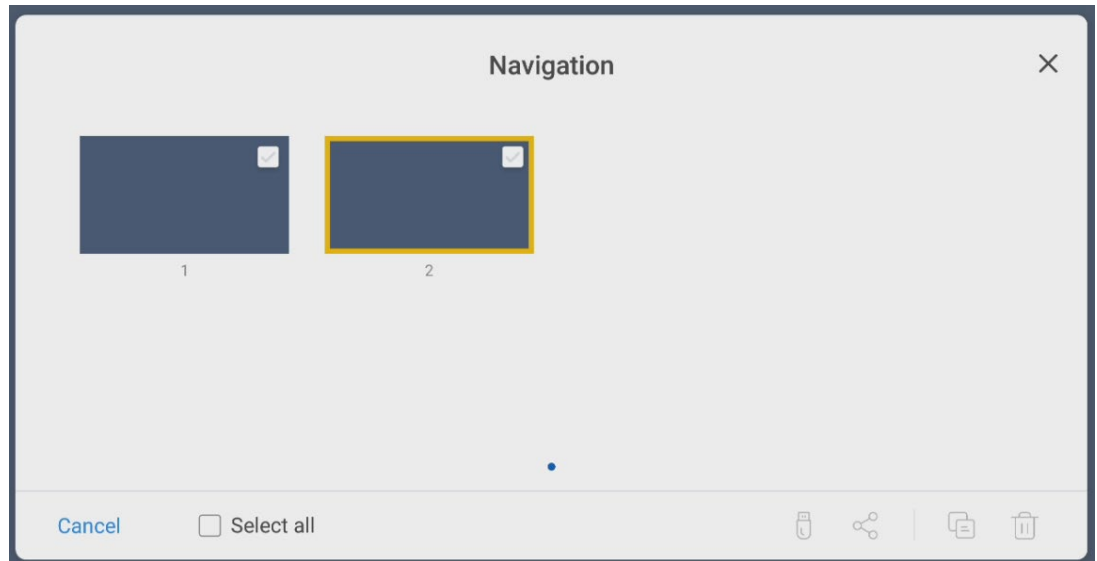

4.4.2 Whiteboard Setting

Tap the  icon to enter the settings bar, users can set the object recognition, action hint and default settings.

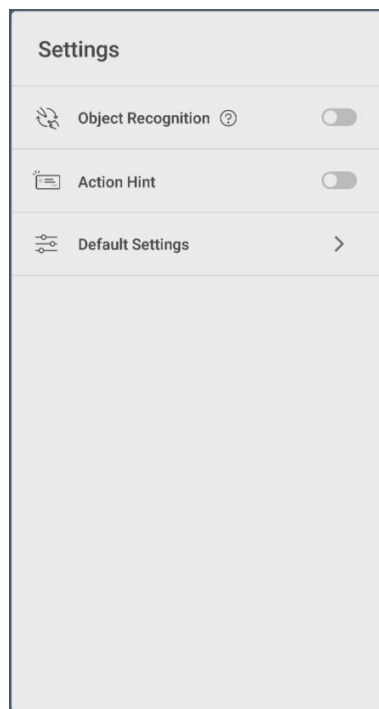

Object recognition

Users can drag the slider to enable the object detection function, users can only write with fine pen in this mode, as shown in the following figure:

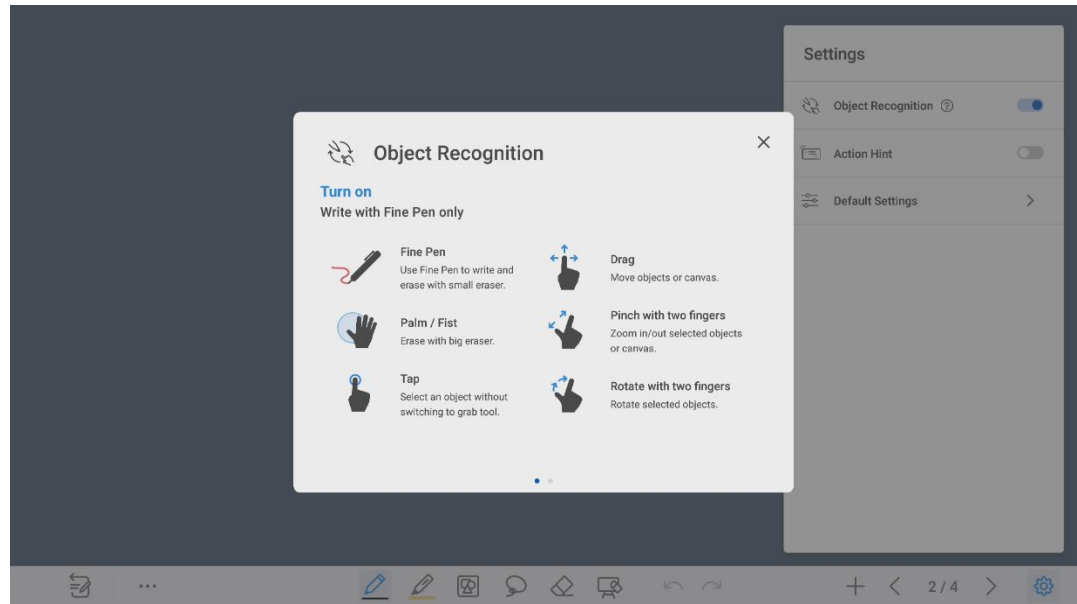

- Fine Pen (2mm): User Fine Pen to write and erase with small eraser.
- Fist/palm: identified as an eraser (100 pt).
- Tap: select an object without switching to grab tool.
- Drag: move objects or canvas.
- Pinch with two fingers: zoom in/out selected objects or canvas.
- Rotate with two fingers: rotate selected objects.



Action hint: drag the slider to enable the action hint.

Default settings: Tap > to enter default setting page, users can set whiteboard page background, change the color and thickness of Smooth Pen and Highlighter.









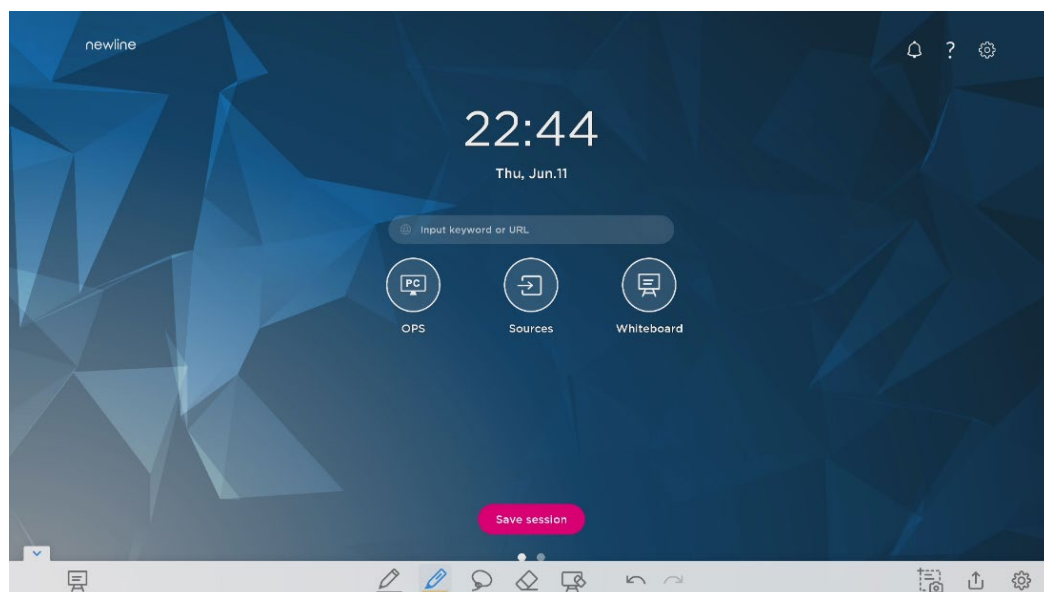

4.5 Annotation

In annotation mode, the system generates a transparent layer at the top of the screen, and users can add annotations to the transparent layer until the annotation mode is exited.

The user can enter the annotation mode through the following two methods:

- Tap the “” icon in the floating bar;
- In the “Whiteboard” interface, tap the “” icon.



Icons	Name	Functions
	Whiteboard	Tap the icon to enter the whiteboard interface.
	Smooth pen	Tap to use the smooth pen function, and the icon turns into blue. Tap and hold the icon for two seconds to set the size and color.
	Highlighter	Tap to use the highlighter function, and the icon will turn blue. Tap and hold the icon for two seconds to set the highlighter size or color.
	Select	Tap the icon to select and edit the whiteboard content. When the object is selected, users can move, zoom in/out, copy, cut, rotate, lock, change layer or delete object.
	Eraser	Tap the icon to enter the eraser function. Tap again to choose the eraser size.
	Clear all	Clear all content on the current page.
	Undo	Tap the icon to return to the previous step.
	Redo	Tap the icon to restore the action that was cancelled in the previous step.
	Screenshot	Tap the icon to save the screenshot of the current page in the minutes.
	Share	Tap the icon to share the annotation notes to the mail or local files.

Icons	Name	Functions
	Settings	Tap the icon to enter the Setting interface.

NOTES:

For saving screenshots when OPS or other external signal source is displayed, please plug USB flash memory to the "USB3.0 Embedded" port on the back of the screen.

4.6 Tutorial

On the homepage, Tap ? icon on the upper right corner to enter the tutorial interface, users can swipe left and right with fingers to switch the tutorial page. There are 10 pages in the tutorial page, which respectively show the quick use of the product.

On the tutorial page, Tap the ? icon on the upper right corner to exit tutorial.



4.7 Floating bar

In the toolbar, press the black area above and pulled out, the sidebar can be transformed into a floating bar.

In the floating bar, users can tap the icon to enter function interface, add and delete icons, add custom icons, drag the floating bar with their fingers to move around on the screen.

Standard > Minimized



(绘图要求: 增加手势点按红色框区域)

Standard > Favorite





(绘图要求: 增加手势点按红色框区域)

Add and delete icons:

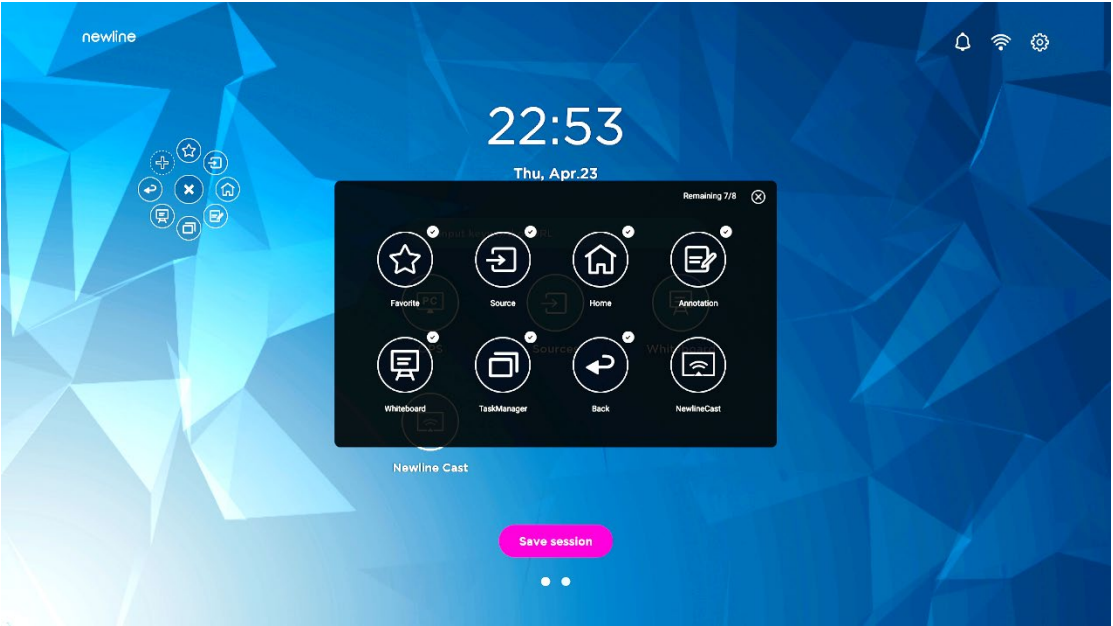
In the floating bar interface, tap the  icon to show the following interface, users can tap the icon to add and delete icons. Icons with ✓ on the upper right corner will display in the floating bar.



Add and delete favorite icons:

In the floating bar interface, tap the  icon to show , tap + icon to show the following interface. users can Tap the icon to add and delete icons. Icons with ✓ on the upper right corner will display in the floating bar.



Delete icons:





In the floating bar interface, long press the icons to enter the icon deleting status, tap the × icon on the upper right corner to delete icons.

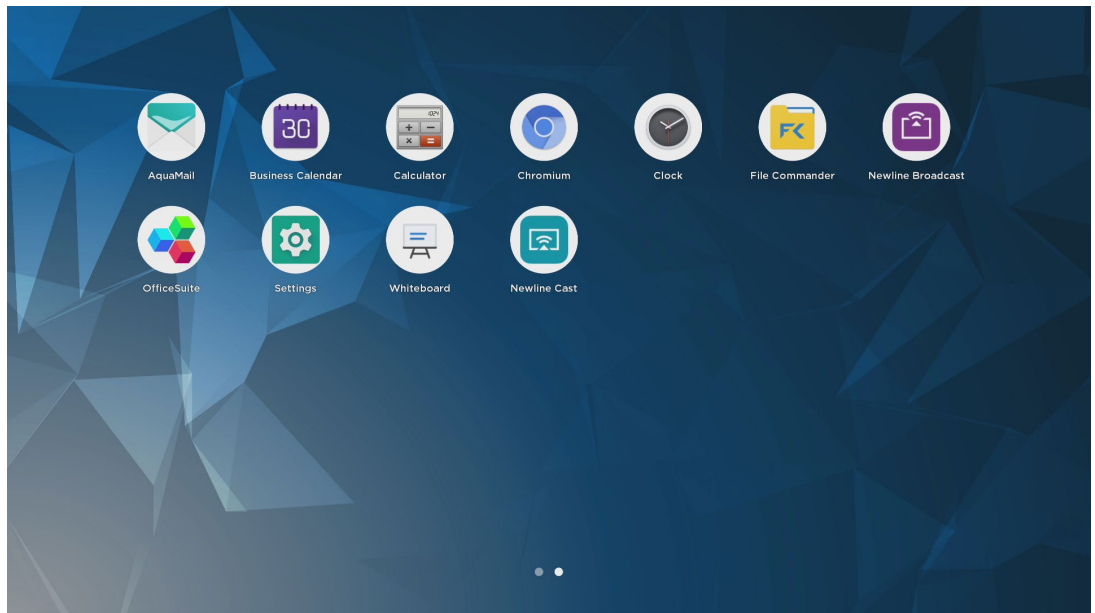

4.8 Gadget

Gadget displays all pre-installed applications. Tap the icon of an application to run the application. The user can enter the gadget through the following two methods:



- On the homepage interface, swipe left to switch to the gadget interface;
- In the toolbar interface, tap the “” icon.

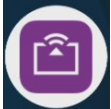

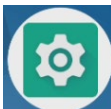
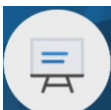
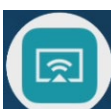
Name	Icons	Functions
AquaMail		Tap this icon to enter the email application and send files. Before sending files, you need to add an email account.
Business Calendar		Tap this icon to enter business calendar application.
Calculator		Tap this icon to enter the calculator application.
Chromium		Tap this icon to enter chromium application.
Clock		Tap this icon to enter clock setting interface.

Name	Icons	Functions
File commader		Tap this icon to open the File Manager and you can explore all internal and external files on the screen.
Newline Broadcast		Tap this icon to enter the Newline Broadcast application.
Office viewer		Tap this icon to enter the Office viewer application. In this application, you can view office files, including excel, word, power point, and PDF files.
Settings		Tap this icon to enter settings interface.
Whiteboard		Tap this icon to enter whiteboard application.
Newline Cast		Tap this icon to enter the Newline Cast application.

4.8.1 Newline Cast

Multiple devices can be cast  essly to the display through several casting modes (Airplay, Google Cast...). To cast: Tap  on the gadget Page to enter Newline Cast. On screen directions will appear for you to follow in order to wirelessly cast to the display, as shown in the following figure:

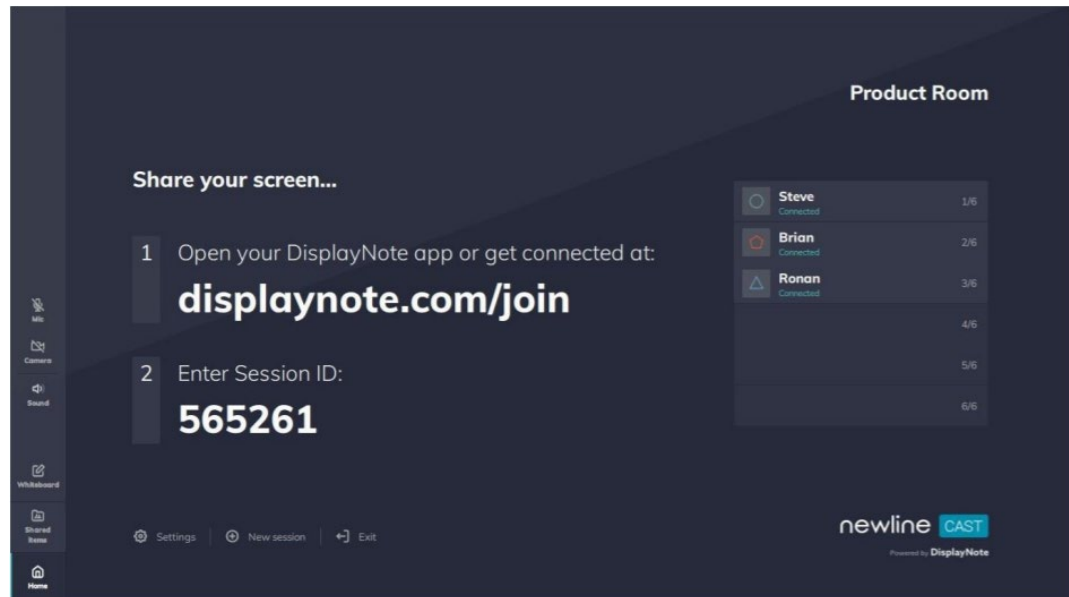

4.8.2 File Commander

Tap the “” icon in the “**Gadget**” interface or toolbar to enter the file manager interface. The interface displays the content of local files of the current system. If any external mobile devices (such as USB storage device, removable hard disk, etc.) are connected, the file content of the mobile device will be displayed at the same time.

Enter the **Files** application, you can tap the submenu at the left side according to requirements, preview internal storage, external storage devices connected via the USB ports, cloud stored files, FTP uploaded files, and local network files, as shown in the following figure.

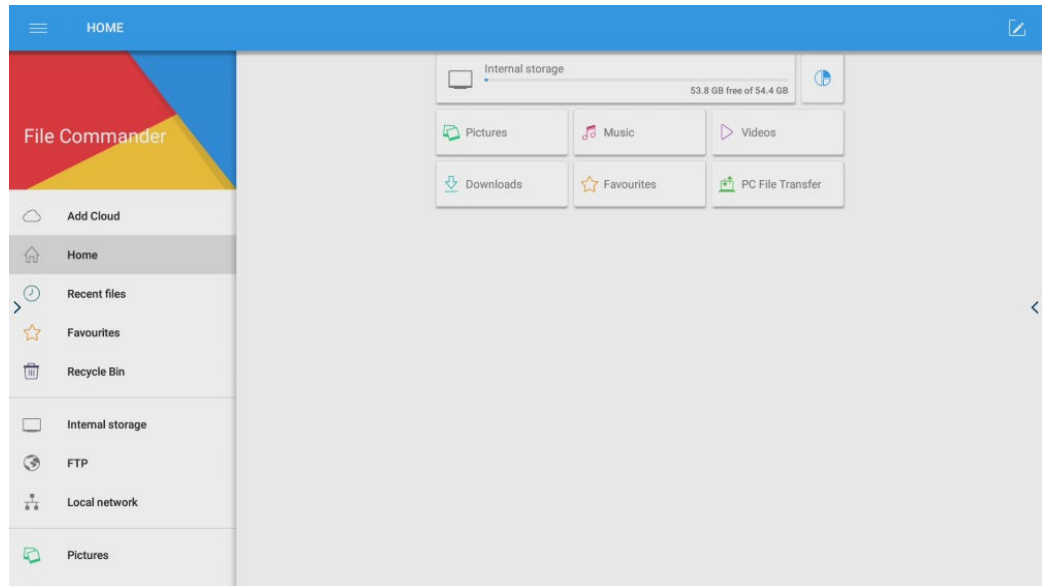

File Management

The touch screen supports connection to USB flash memory. Enter the File application, you can preview all files in the internal storage and storage devices connected via USB ports and select, copy, paste, delete and search for files.

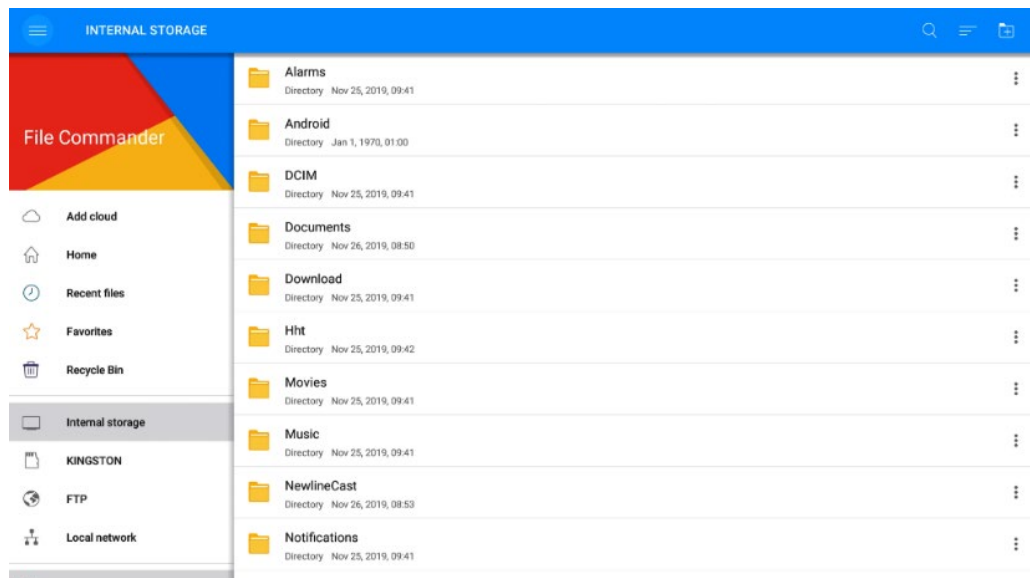

File Filtering

You can tap the menu at the left side to display files by types, for example: **Documents**, **Pictures**, **Music**, **Videos**, **Archives** and **Downloads**.

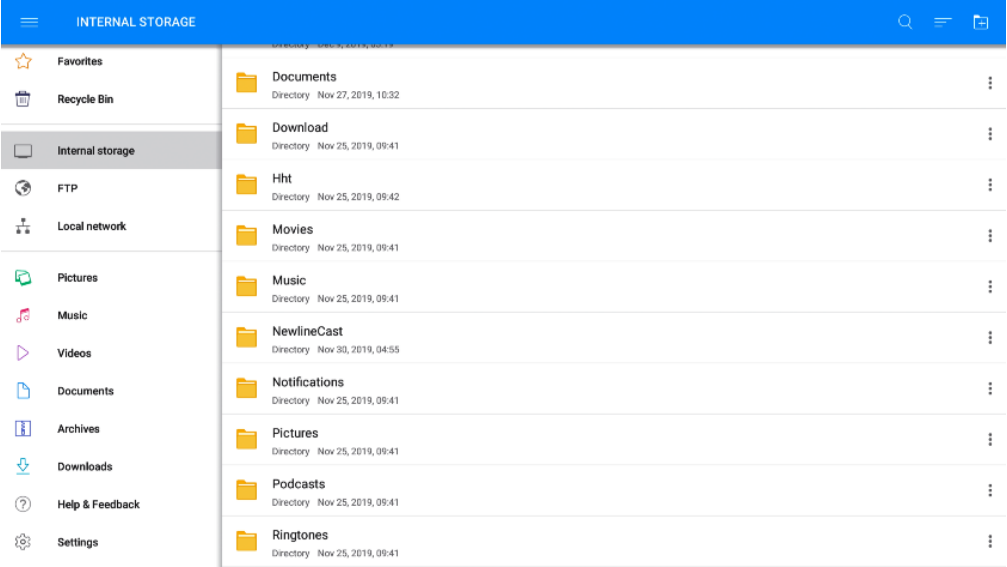

You can also tap  on the top right corner to filter files by **View mode**, **Sort by**, **show only**.

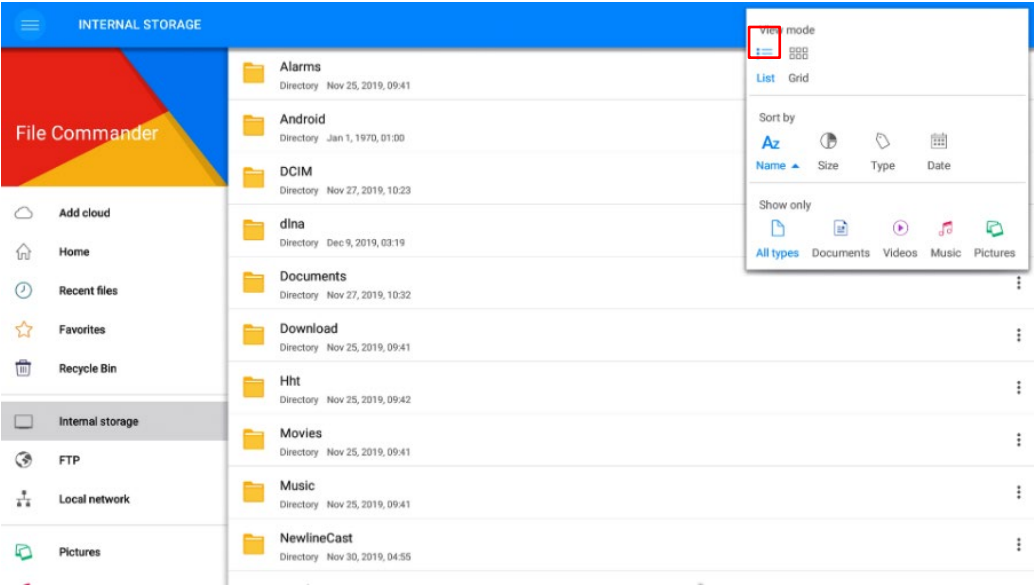

File Search

Enter the **Files** application, and tap  in the dialog box that is displayed, enter keywords in the search box according to requirements. The system will display a list of files that match the keywords.

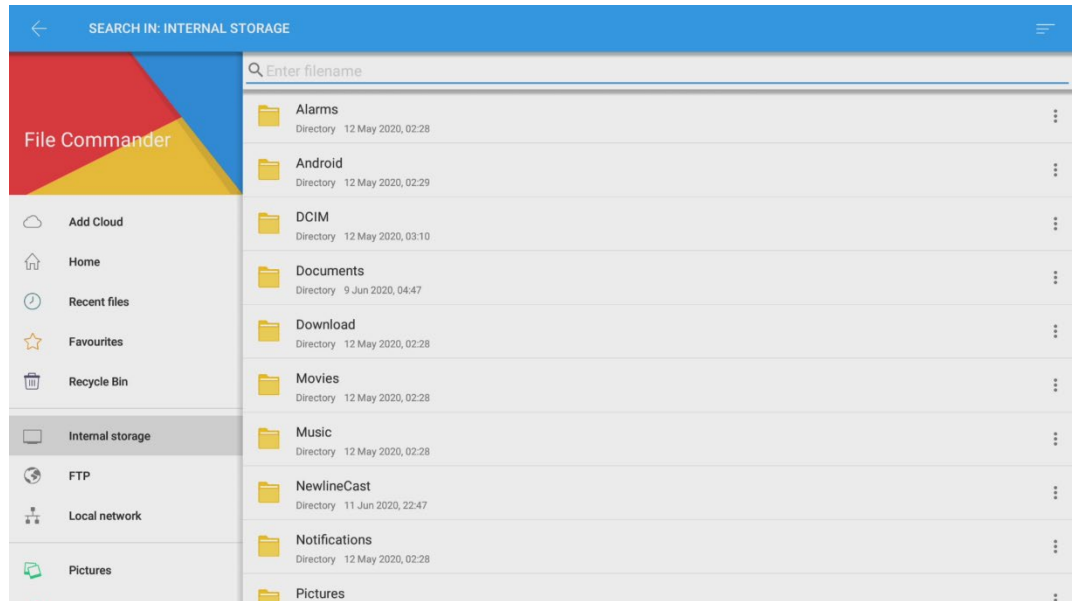

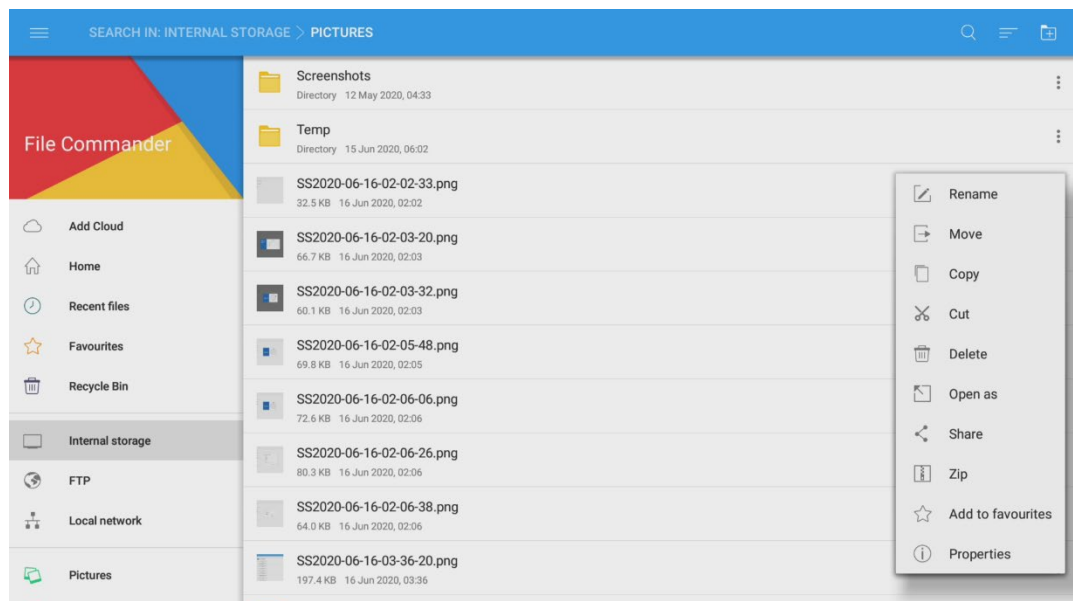

File Operation

Enter the **Files** application. You can create folders according to requirements, select files, and set **rename/move/copy/cut/delete/open as/share/zip**. For details on other operation, tap  in the right side for more operation.



4.9 System Settings

Enter the system setting page using one of the following methods:

- Tap  on the **Home** page.
- Press  on the remote control.

- In the **Quick Setting Menu**, Tap the  icon.

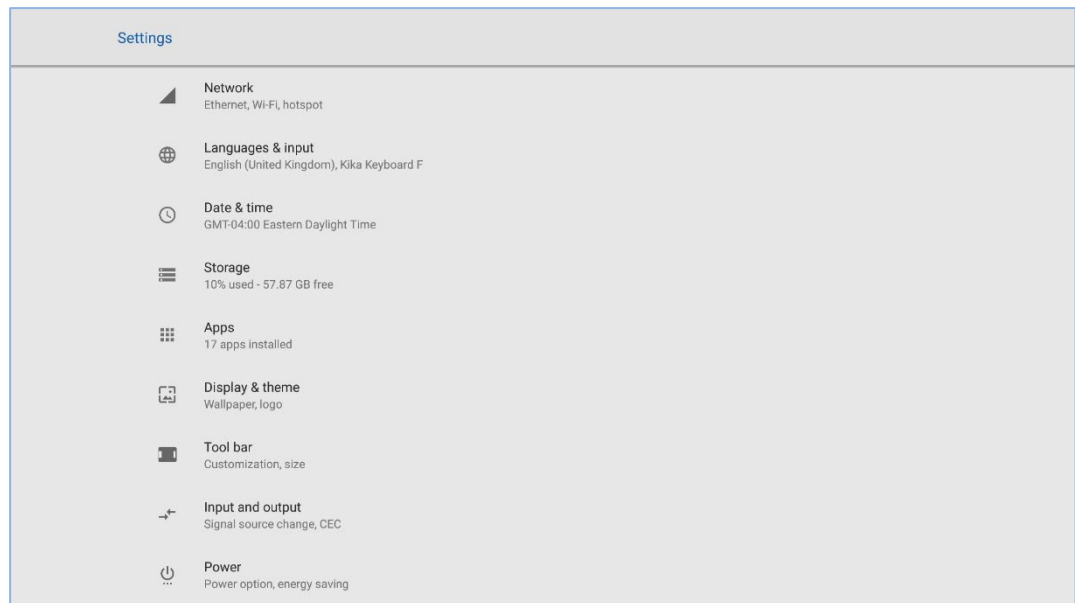

4.9.1 Network Settings

Enter the **Network** submenu to enable Wi-Fi or Ethernet, view network information, and enable the Wake up via LAN function.

- **Wi-Fi**: Tap the corresponding button to enable the Wi-Fi function.
- **Ethernet**: When the RJ45 port is properly connected to the network cable, tap the corresponding button to enable the Ethernet function. User can View the MAC address, IP address, gateway, subnet mask, and DNS information. The user can customize settings to automatically obtain an IP address of the LAN or set a static IP address as needed.
- **Hotspot & tethering**: The user can customize relevant settings for portable Wi-Fi hotspot.
- **Other Settings**: The settings of the proxy server and network mode.

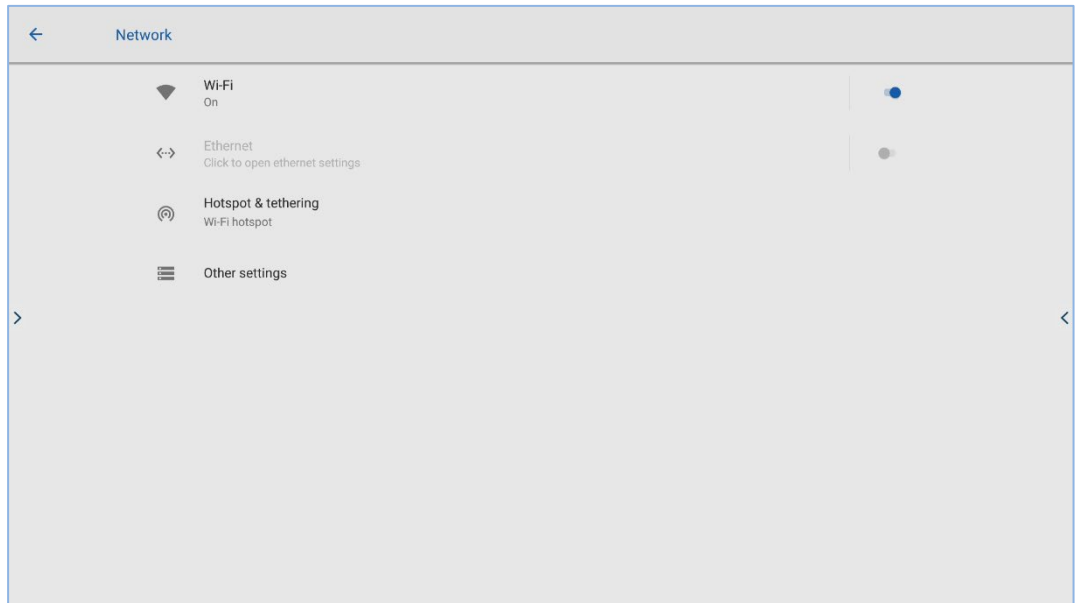

4.9.2 Language and Input

Enter the **Language & Input** submenu to set language and keyboard. The default input method of the system is **Kika Keyboard F**, and **Hardware** must be enabled.

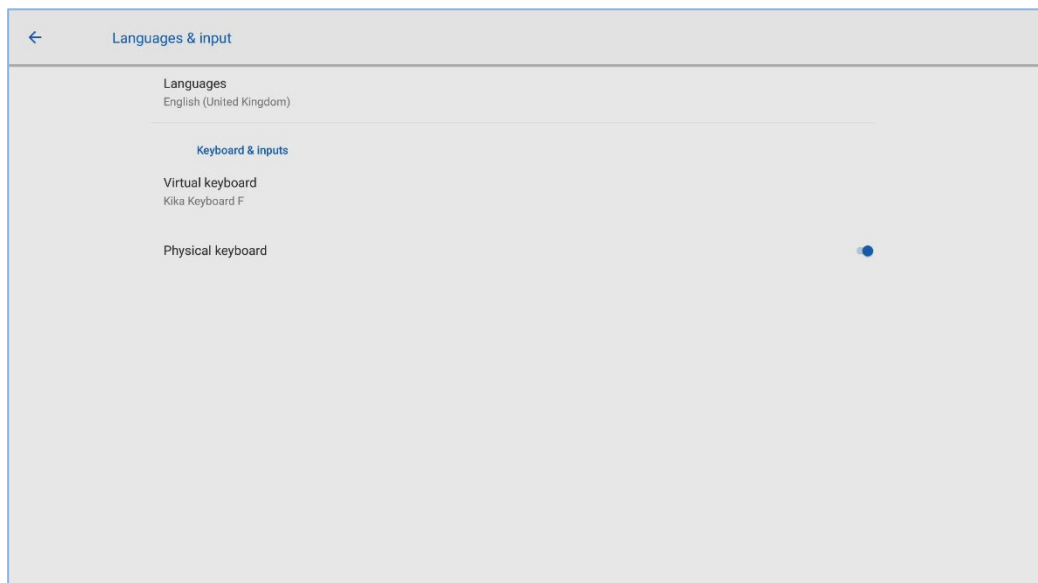

Setting a Language

Tap **Language** at the left side. In the **Change language** dialog box that is displayed, select a language or Tap **Add language** to add a language.

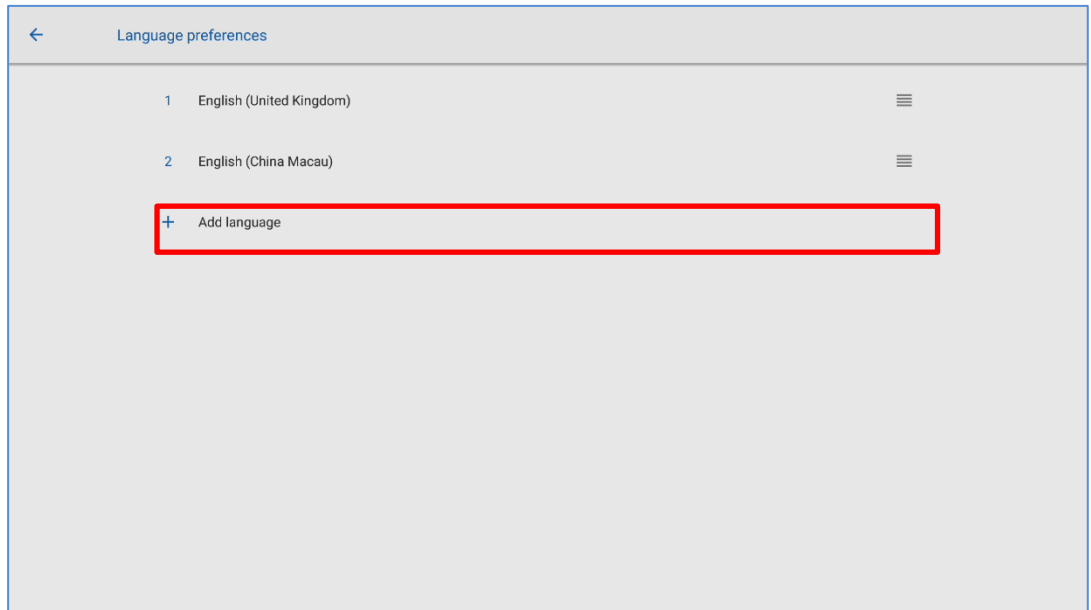

4.9.3 Date and Time Settings

Enter the **Date & Time** submenu to set the date and time. Before setting the date and time, users should tap **Select time zone** to select local time zone.

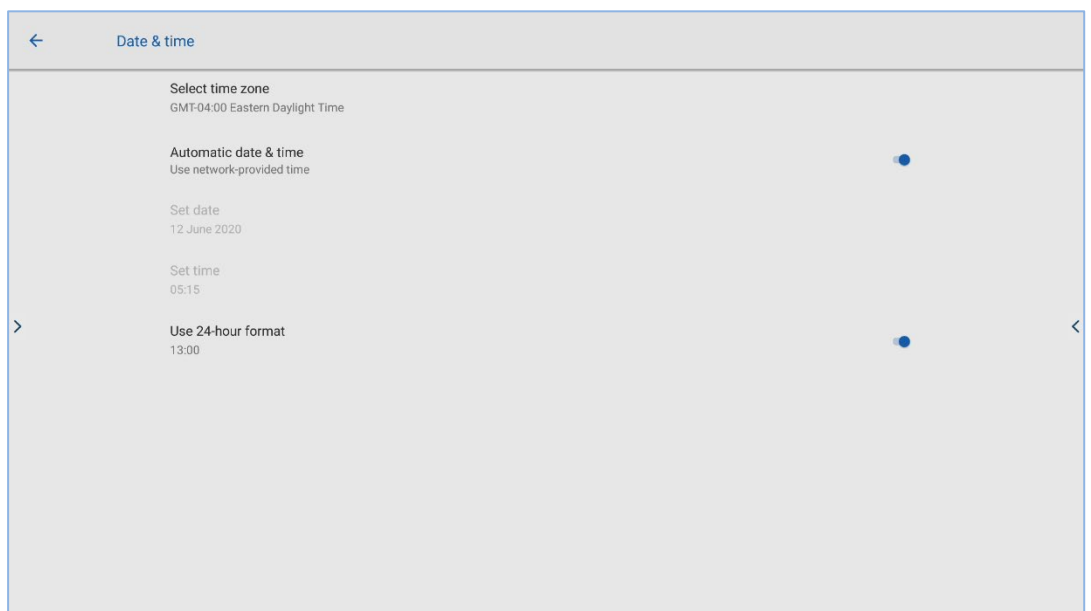

Setting a Date

You can automatically obtain the system date or customize a date.

- To automatically obtain a date, select **Automatic date & time**.

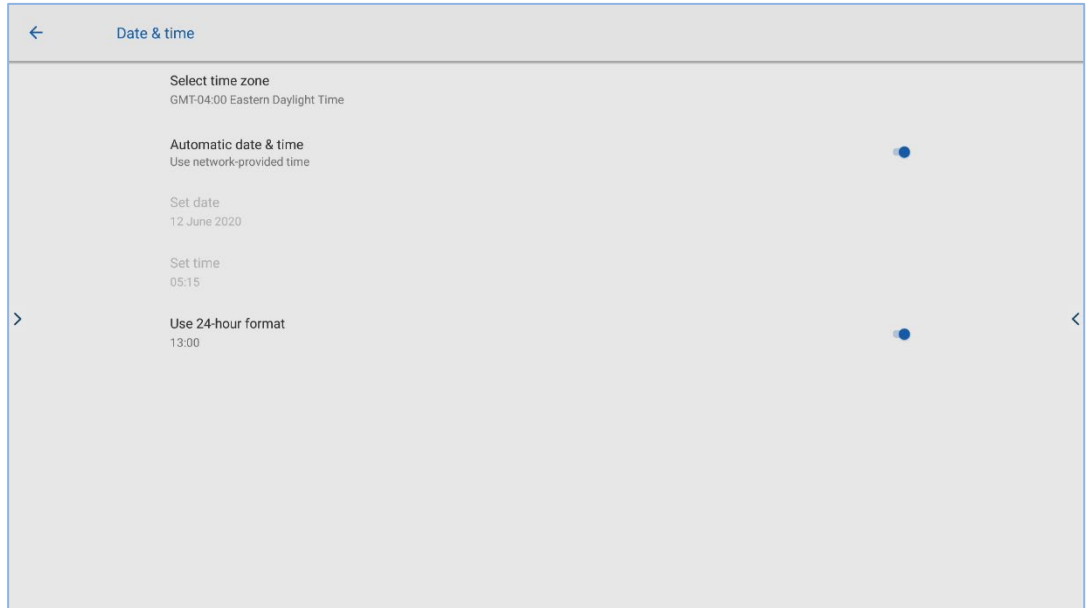

- To customize a date and date format, set them in **Set date**.

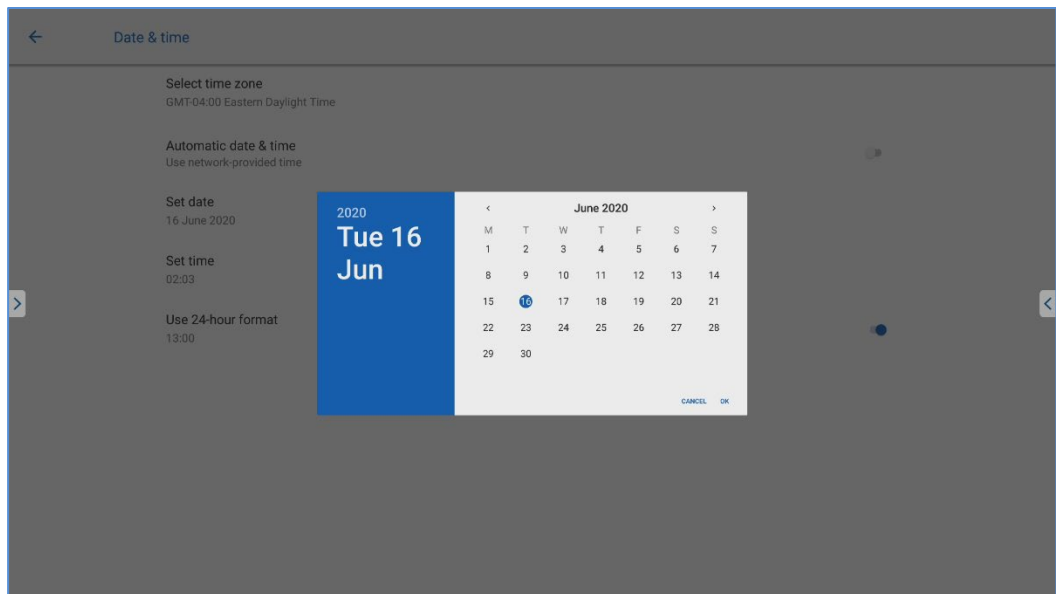

Setting Time

You can automatically obtain the system time or customize time.

- To automatically obtain time, select **Automatic date & time**.

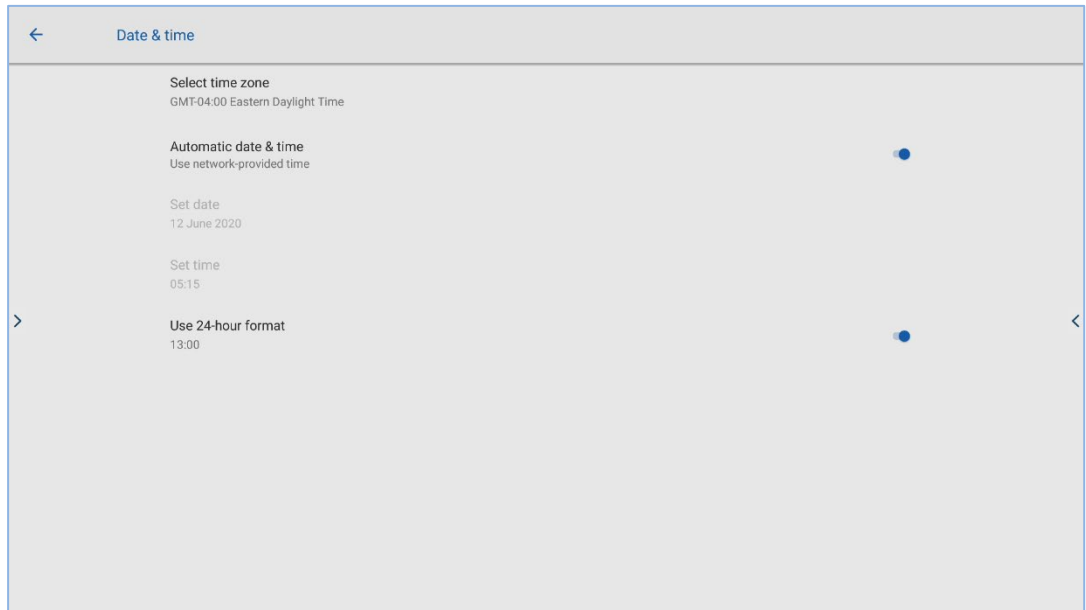

- To customize time and time format, set them in **Set time** and **Use 24-hour format**.

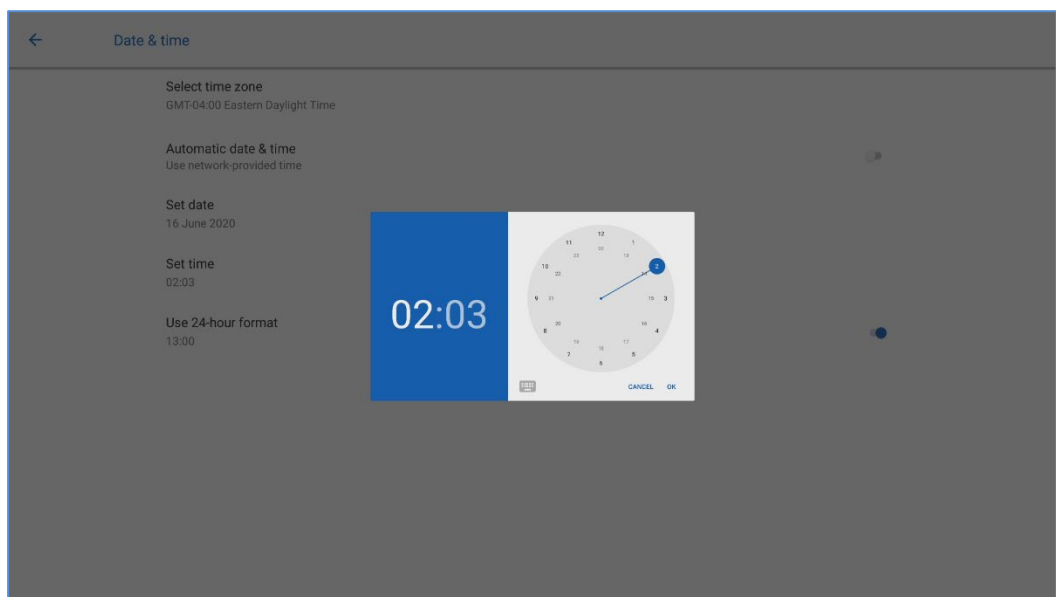

 **NOTE**

Time format will be 24-hours mode only when the **Use 24-hour format** is selected, otherwise time format will be 12 hours mode.

4.9.4 Storage

Enter the **Storage** submenu to view space distribution of the internal storage.

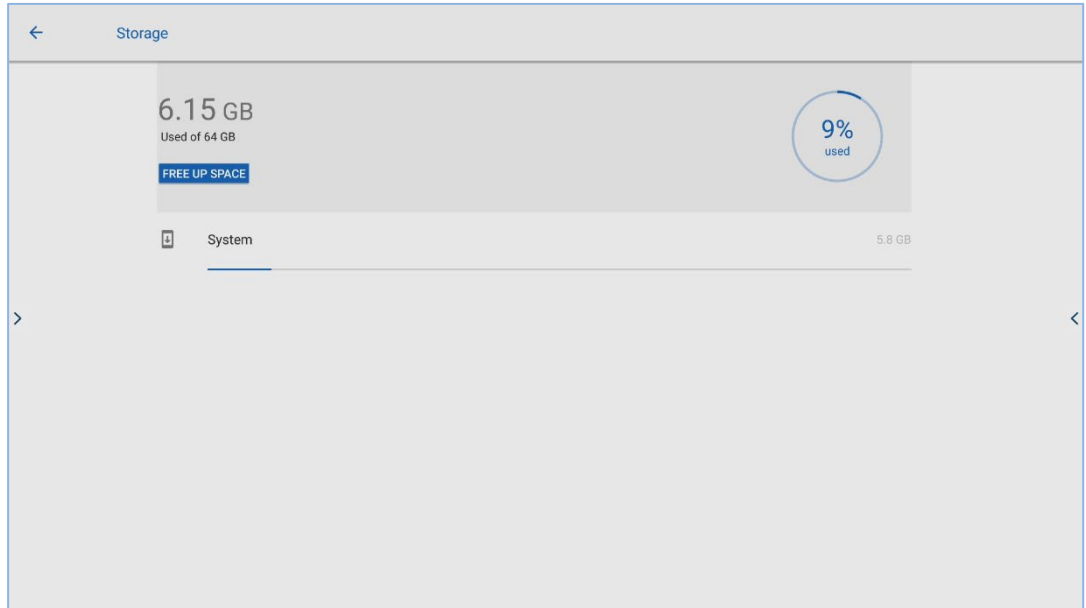

4.9.5 Applications

Enter the **Apps** submenu to view downloaded applications by type, running applications, and all applications.



4.9.6 Display & Theme

Enter the **Display & Theme** submenu to set the theme, wallpaper, logo and font size.

- **Theme:** Standard, abstract, galaxy, forest, classic, five theme can be set;

- **Wallpaper and logo:** users can use default wallpaper and logo, or customize the wallpaper and logo from file viewer;
- **Font size:** drag the slider to change the font size.

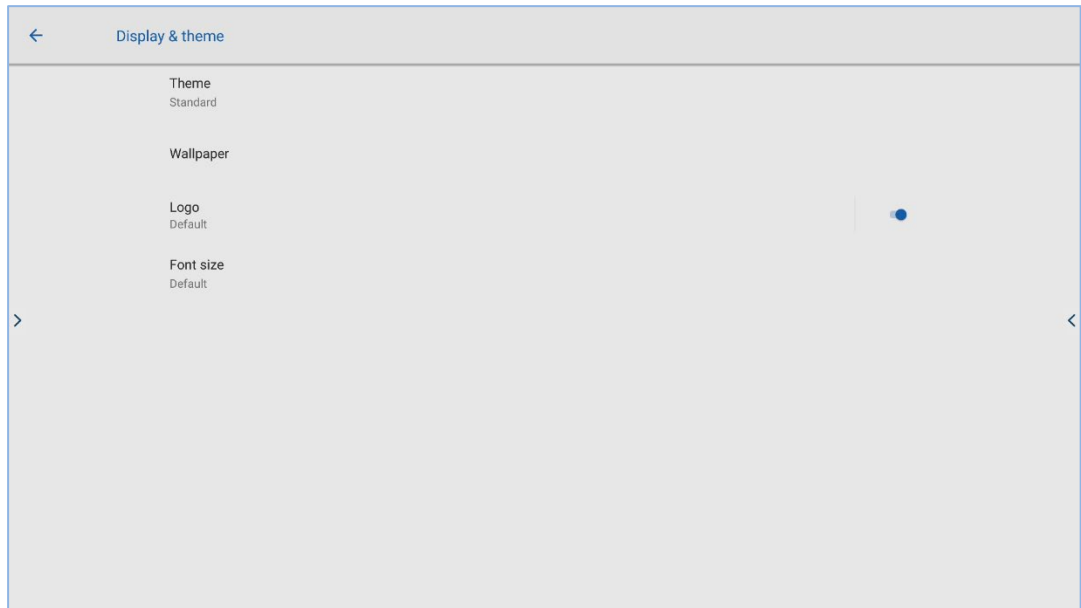

4.9.7 Tool bar

Enter the **Tool bar** submenu to enable tool bar and quick setting, modify the toolbar icons and toolbar size.

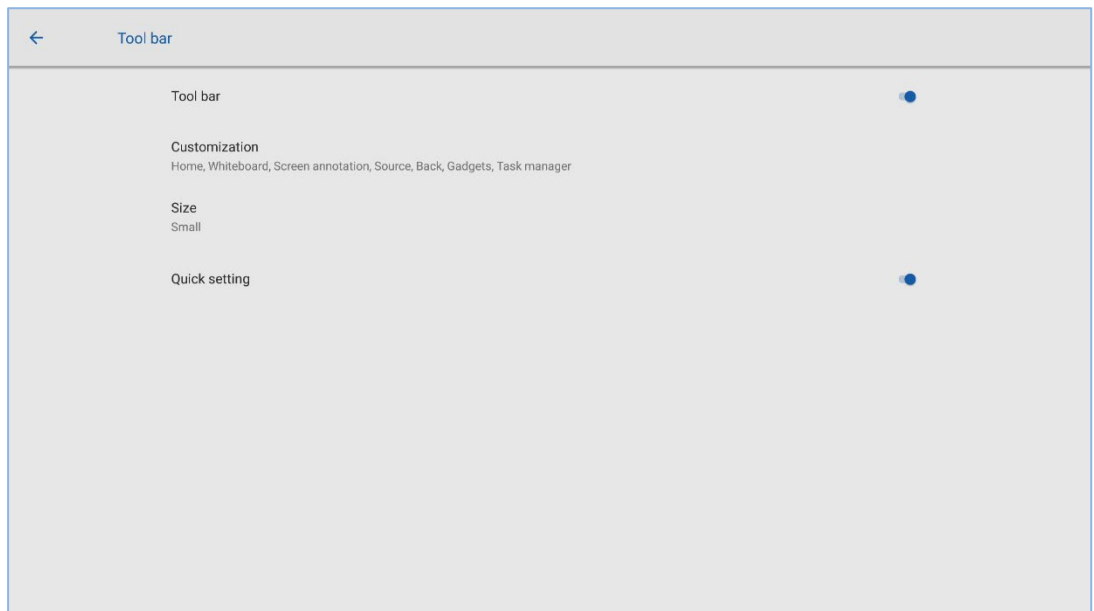

4.9.8 Input and Output Setting

Enter the **Input and Output** submenu to set the Home source and USB connection, enable new input source, CEC auto and microphone.

- **Home source:** Customize settings to connect to the signal source after power on. The options are Smart system, HDMI1, HDMI2, VGA, FRONT HDMI, OPS, Whiteboard and Newline cast.
- **USB connection:** After you connect the USB flash device to the port, you can choose your USB Connection. OPS, Smart system and public can be set.
- **New input source:** After the **New input source** function is enabled, the system can automatically switch to the screen of the newly connected signal source.
- **CEC Auto Power On:** “CEC Auto Power On” is enabled, When the HDMI port of the machine is connected to a CEC device (such as a DVD), and both the CEC device and the machine are turned off, if the CEC device is turned on, the machine automatically turns on after receiving command from the CEC.
- **CEC Auto Power Off:** “CEC Auto Power Off” is enabled, When the HDMI port of the machine is connected to a CEC device, and both the CEC device and the machine are turned on, if the machine is turned off, the CEC device automatically turns off after receiving the command; if the CEC device is turned off, the machine automatically turns off after receiving the command.
- **Microphone:** Microphone on or off.

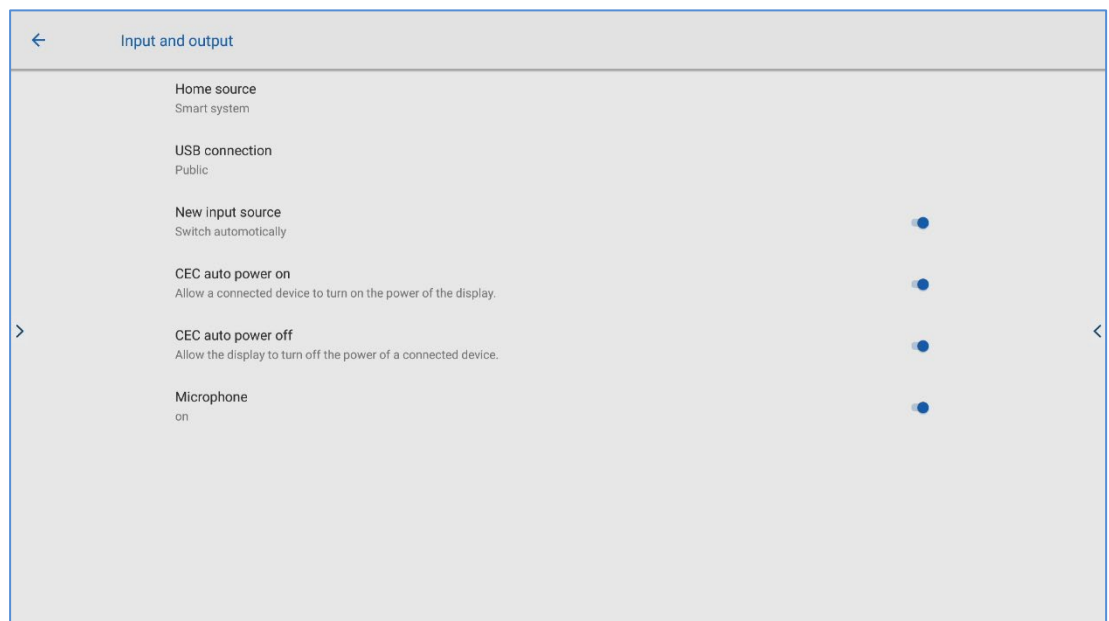

4.9.9 Power ON/OFF Setting

Enter the **Power** submenu to set power on and off as following:

- **Automatic power on/off:** Tap the button to enable the function, users can set the power on/ off on time.

- **Power on/off on time:** Set the power on/ off time, system will automatic power on/off on the customize time.
- **Energy saving:** Set a duration after which the screen enters the lock mode if the screen is left un-operated.
- **Power option:** Set the system enter power off or sleep mode when users press power button or end session.
- **Sleep and touch to wake up:** Tap the button to enable the function, users can touch the screen to wake up the system from sleep mode.

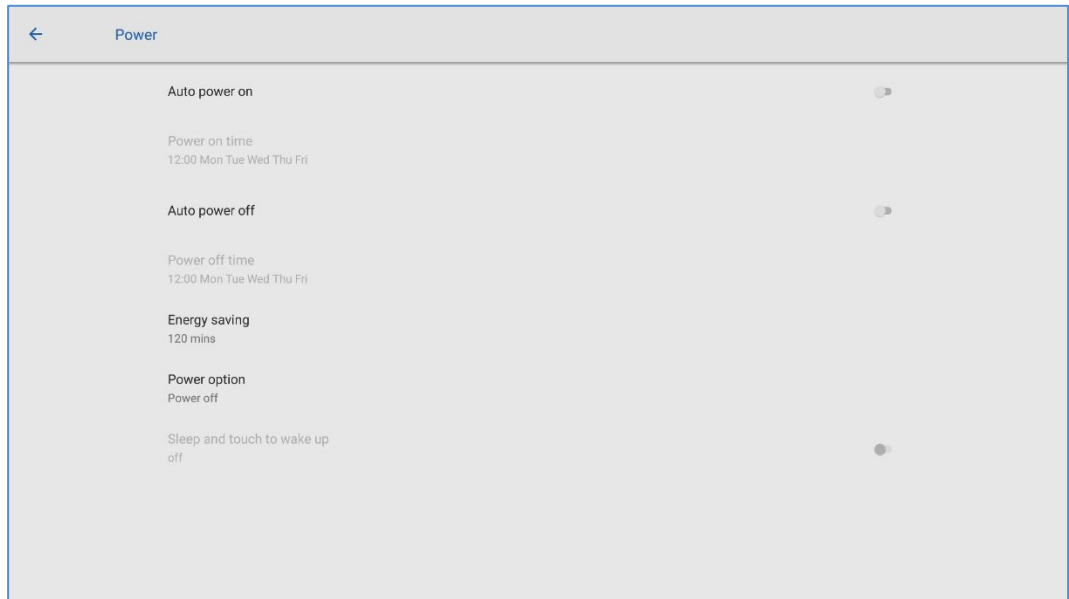

- To set the automatic power on time, select **Auto power on**, and set the power on time in **Power on time**, as shown in the following figure.

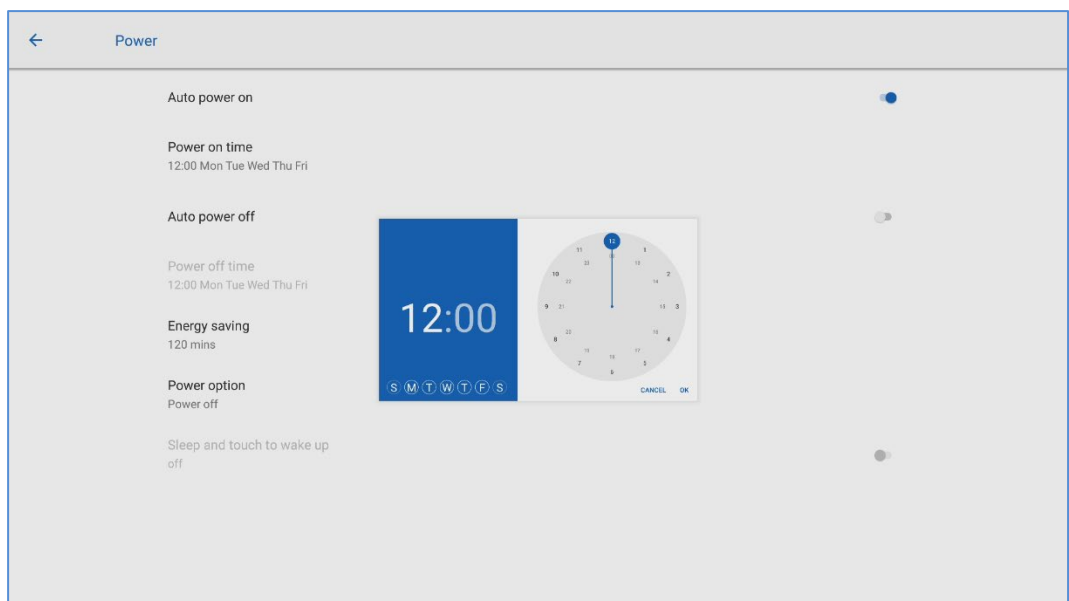

- To set the automatic power off time, select **Auto power off**, and set the power off time in **Power off time**, as shown in the following figure.

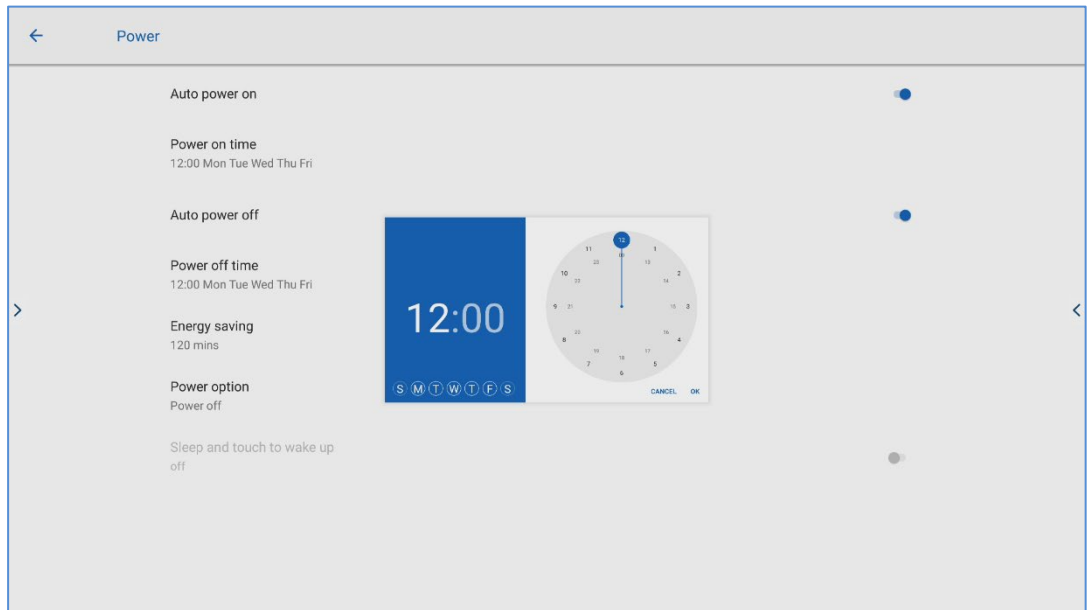

- To set the energy saving time, tap **Energy saving**. In the dialog box that is displayed, set a duration after which the screen enters the lock mode if the screen is left un-operated. After the screen is locked, if the user does not operate the screen within 120s, the screen enters the power off mode. The duration can be set to **30 MIN**, **60 MIN**, **90 MIN**, or **NEVER**. You can also customize this duration and the range is 3 minutes to 480 minutes.



NOTE

NEVER indicates that the automatic power off mode function is not enabled.

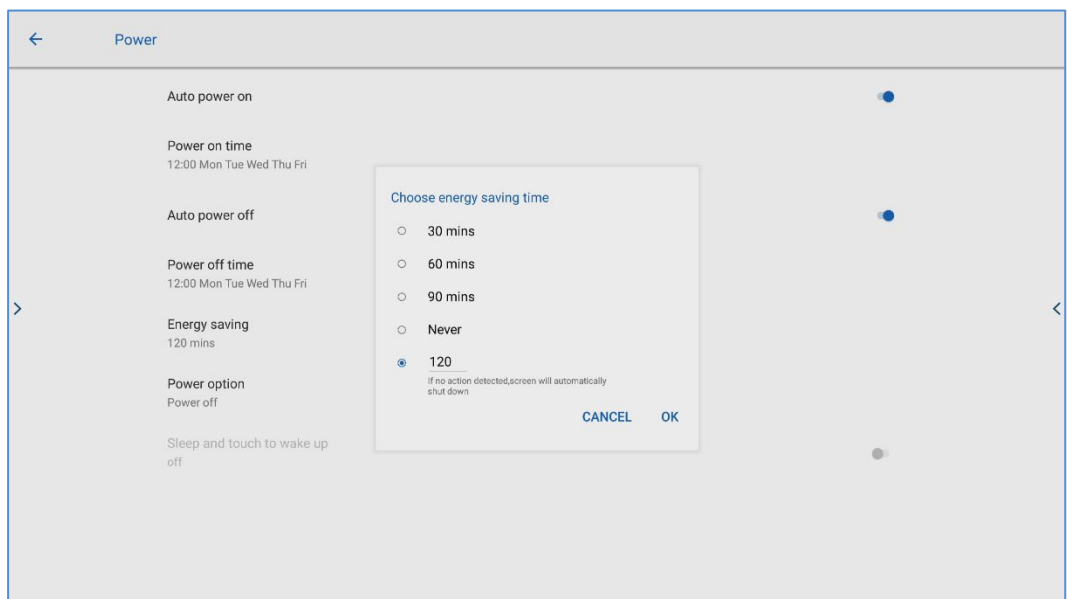

4.9.10 Security Setting

Enter the **Security** submenu to set whether you need enter the password and modified password when you enter the Home page, settings, installation, gadgets or USB. The password is only limited to 6 digits, English letters are not allowed.

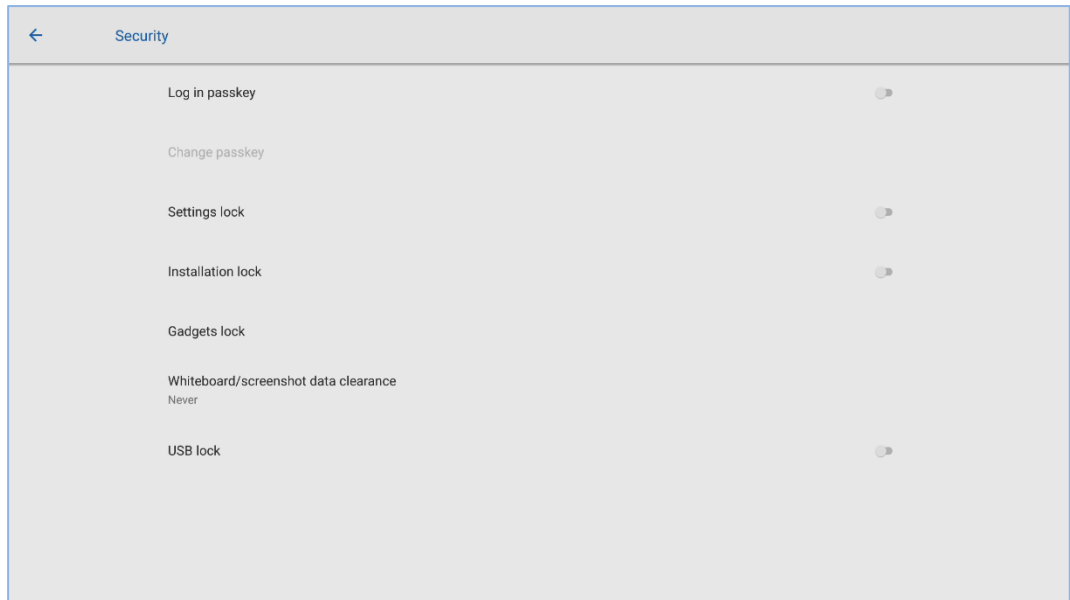

Notes:

- When you drag the slider to enable the setting lock, the setting-related icons will be displayed as locked, and the user needs to enter the password to enter the setting interface.
- When you drag the slider to enable the USB lock, the USB ports, mouse and keyboard will be unusable, the USB device will not be able to read data and the Android or external signal source will be locked.

4.9.11 Smart Eye Protection

Enter the **Smart eye protection** submenu to set **Eye protection writing mode**, **Eye protection brightness control mode** and **Bluelight filter**. Only when **Bluelight filter** is opened can **Filter level** be set.

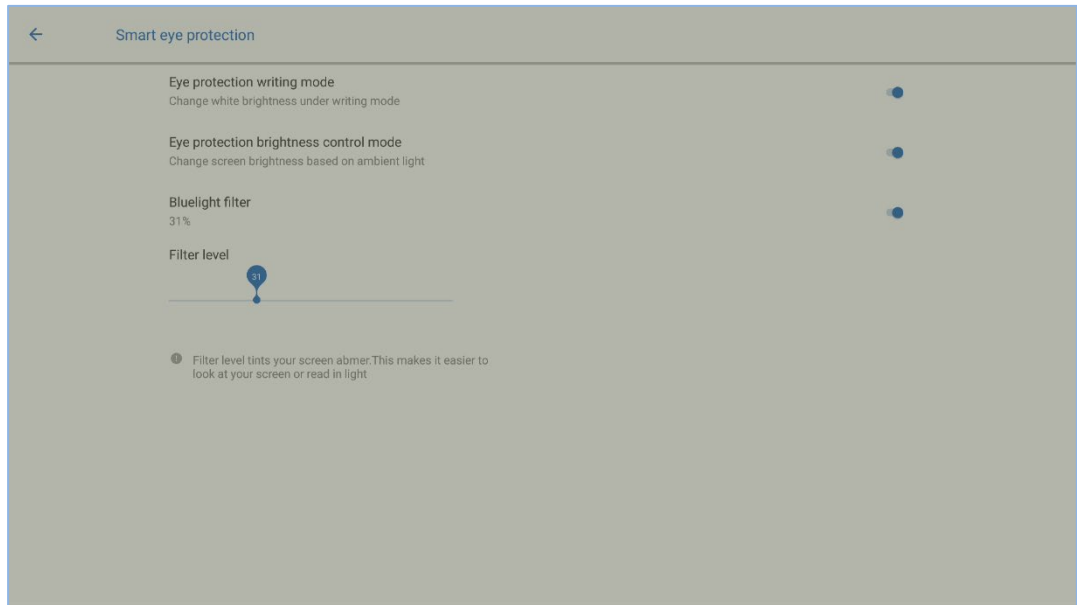

4.9.12 System

Enter the **System** submenu to reset the system or view system upgrade, network update, firmware or system version information, import, export and factory setting.

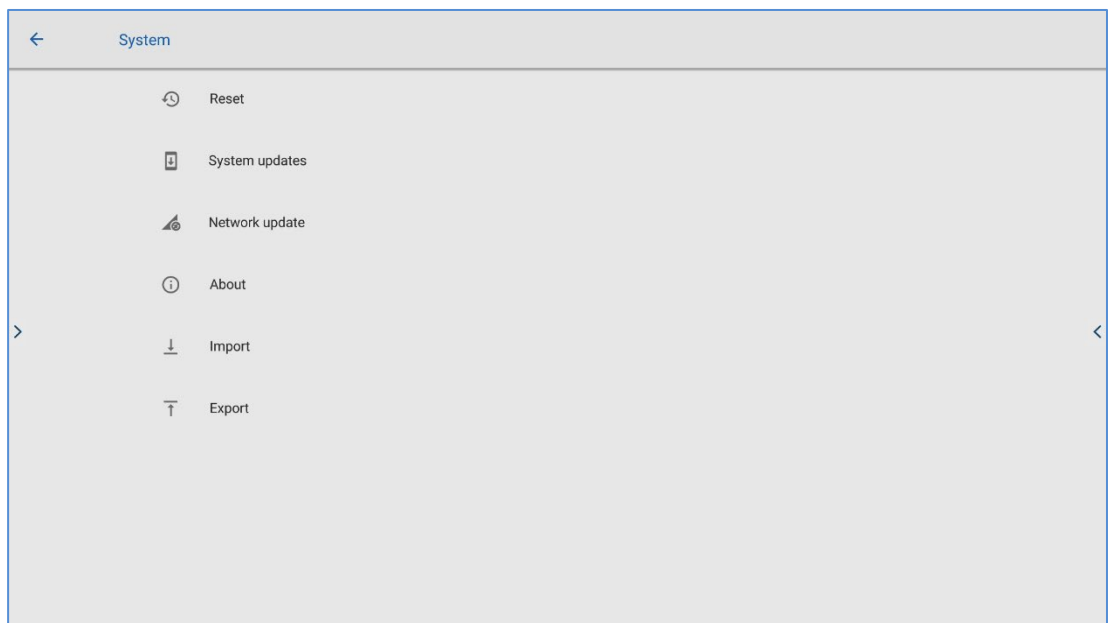



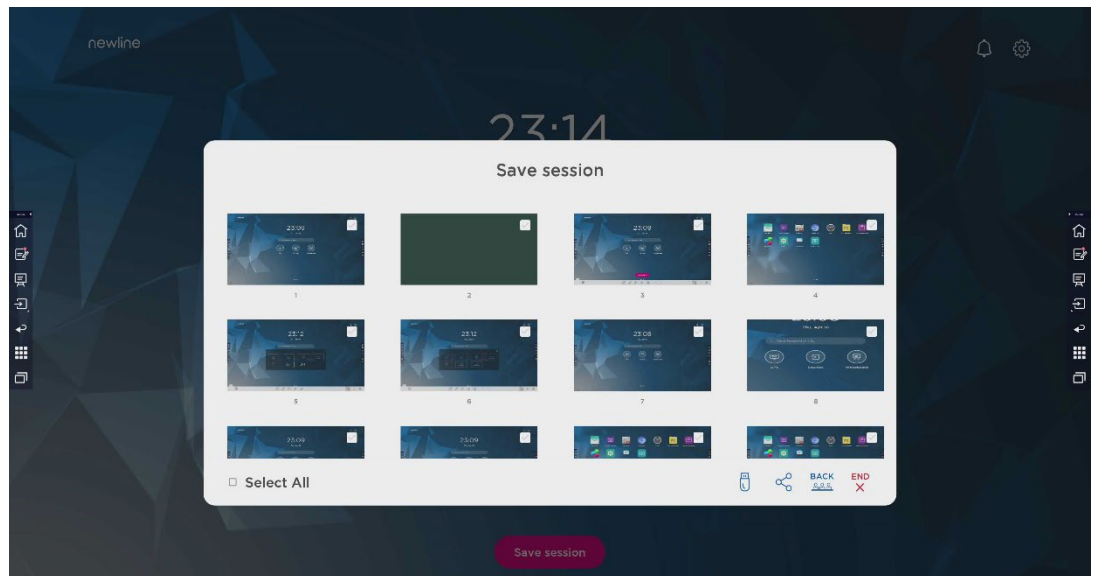

4.10 Save session

Save session button will appear at the bottom of the screen when there is whiteboard data, new screenshot data. Tap **Save session** button or tap the power button to enter the Save session pop-up window. Users can save the session file as their needs.



Save Session Data

When no external USB flash memories are connected, icons will be gray. When an external USB flash memory is connected, icons will turn into blue.

- **Save to USB flash:** Tap the  in blue. The “**newline**” folder will be created under the root folder, and the selected files will be saved in it.
- **Share to mail:** Tap the  icon to share the files. Tap **AquaMail** to share current session files by email.
- **Back to session:** Tap the  icon to back to session. The session will be continued; session data are not cleared.
- **End session:** Tap the  icon to end session. The **Warning** dialog box will be displayed.
- Tap **Confirm**. All writing pages and screenshots will be deleted and touch screen will be powered off.
- Tap **Cancel**. The session continues and the system go back to the **Home page**.

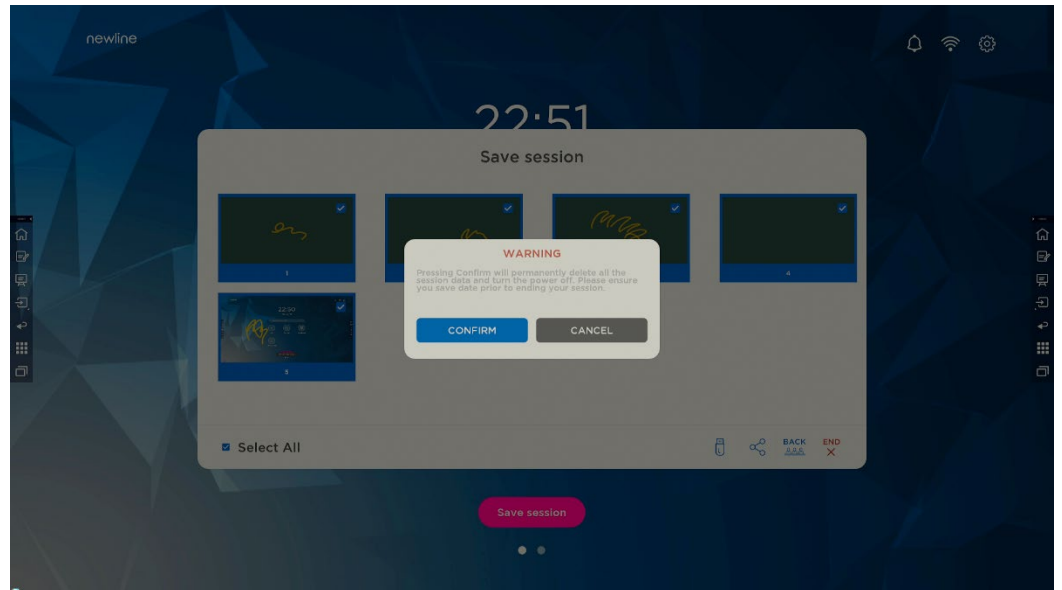

NOTE

- Picture files are named in the following of prefix + creation file. Slide up/down using a finger to switch pictures. Prefix name rule: WB (discussion mode page), AN (annotation page screenshot), and SS (remote control screenshot).
- Do not eject USB flash memory before completing the saving process.
- If the USB flash memory is bigger than 16GB or the file format is not FAT32, the data will not be saved properly.

4.11 Automatically End Session

If the touch screen is left un-operated for a specified duration, it will be locked to guarantee your privacy. Choose **Settings > Power > Energy Saving** to set the duration. For details on the setting method, see “Power ON/OFF Setting”.

After the display is locked, if it is operated again within 120 seconds, the display is unlocked. Otherwise, the display enters the shut down mode and automatically deletes all session content. After the display is unlocked, the countdown dialog box will not appear in current session.

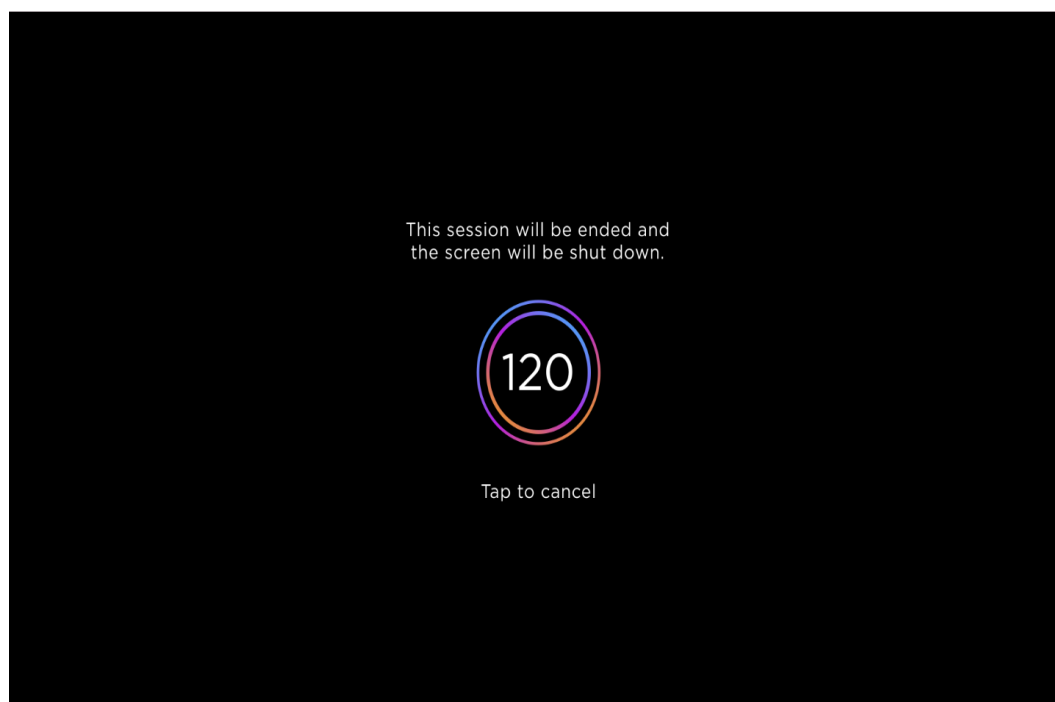

Notes:

Touch screen enter shut down mode by default in energy saving mode. Users can enter “**Settings > Power > Power option**” to set the system to enter sleep mode.

5 Add Shortcut

5.1 Add Shortcuts to Dock

Step 1. Long press any one of icons in the dock bar to enter the editing state. As shown in the following figure:

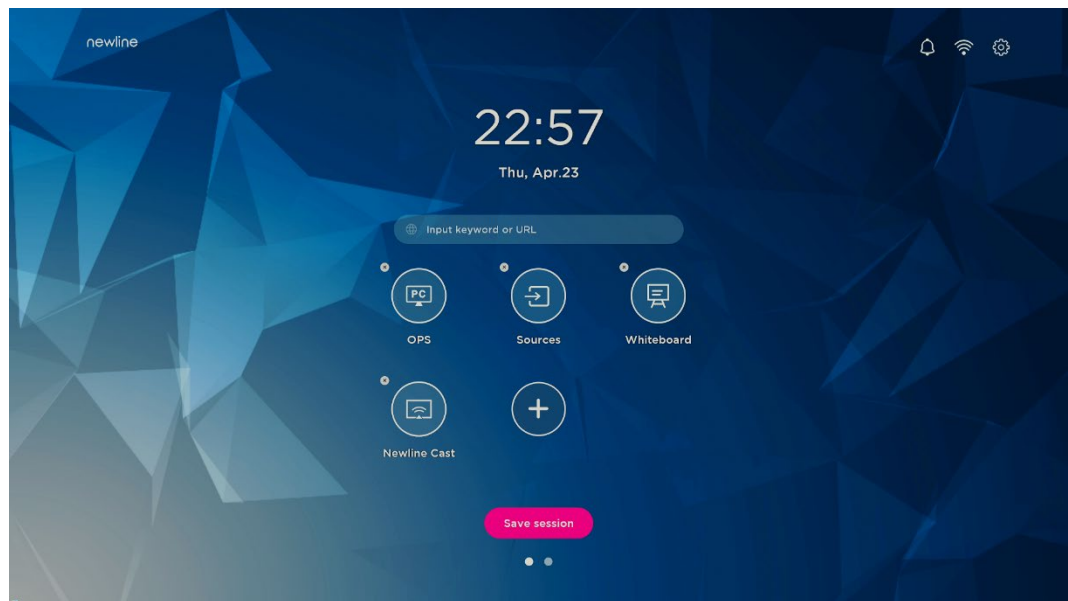

Step 2. Tap the "+" icon to enter the add **Main Icon** interface, users can add up to 6 icons, as shown in the following figure:



Step 3. At the **Home** page, Tap the shortcut icon and you can start the program/application or change to the external signal source.

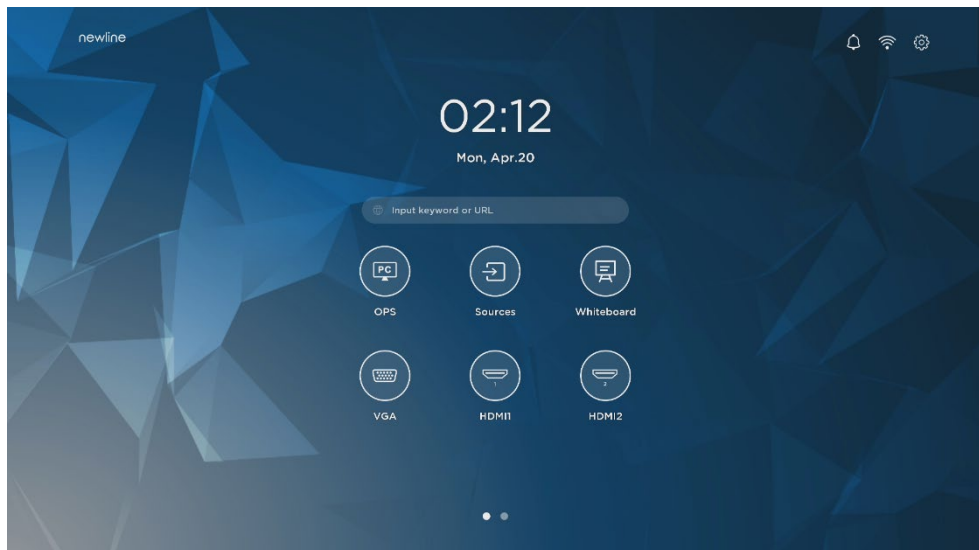

Notes:

Long press the icon to enter the edit state, the + icon will not appear when the 6 main icons are all added.

5.2 Delete shortcuts to Dock

Long press any one of icons in the dock bar to enter the editing state. Tap the × icon in the upper left corner to delete the Main Icon.

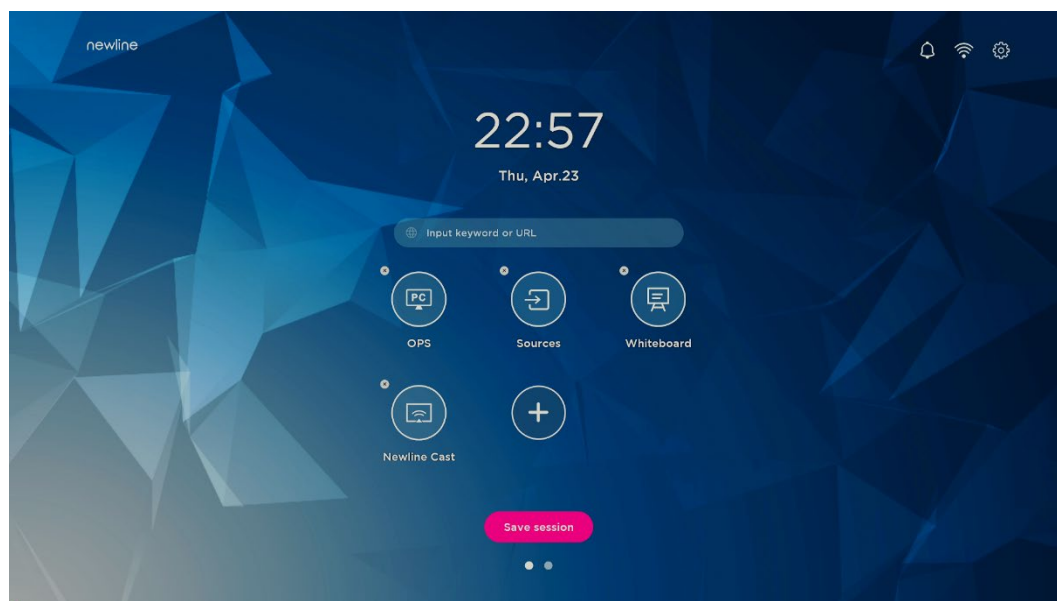

Notes:

Users also can tap the icon name to modify as your need.

5.3 Newline Assistant

5.3.1 Introduction

The Newline Assistant is the tool used as a bridge between the smart system and the OPS Computer (OPS). It helps add Windows software shortcut to the gadget Page, as well as to protect USB data when switching between sources.

Therefore we strongly recommend users install the Newline Assistant after installing the OPS Computer.

5.3.2 Installation

Step 1. Connect OPS Computer correctly (See also "2.4 OPS Computer Installation").

Step 2. On the **Home Page**, tap **OPS**. It will switch the signal source to the Internal Windows system.

Step 3. Visit our website at www.newline-interactive.com and choose **Products > ER series > download** to download the Newline Assistant installation package.

Step 4. Install the [Newline Assistant](#) as instructed.

5.3.3 Add Quick Start Windows Programs in Smart System

Step 1. In Windows, run the **Newline Assistant** program and drag the software icons or folder shortcut icons that you want to add from the desktop or menu to the **Newline Assistant** window. The applications added or deleted through the Windows system will be automatically updated to the smart system until the upload progress reaches 100%. If

there is an application not updated, tap  in the upper right corner to manually update all icons in the Newline assistant window to the smart system.

 **TIP**

Only folders and .exe file are supported.

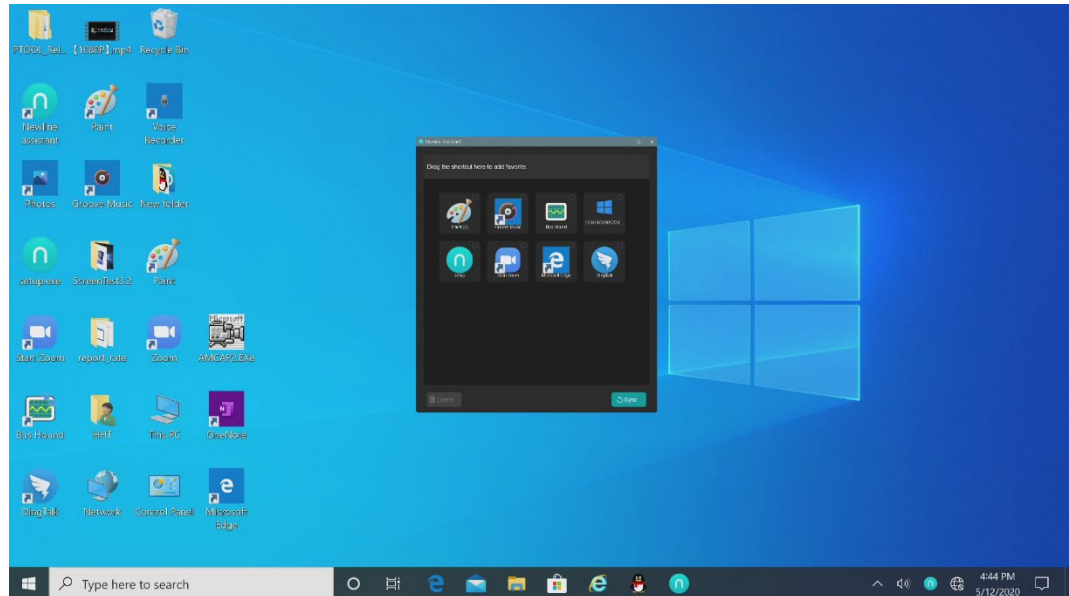

(绘图要求: 增加手势拖动效果图示)

Step 2. Tap the  icon in the sidebar to enter gadget interface to view all the Windows software shortcuts added by the Newline Assistant in **Step 1**.

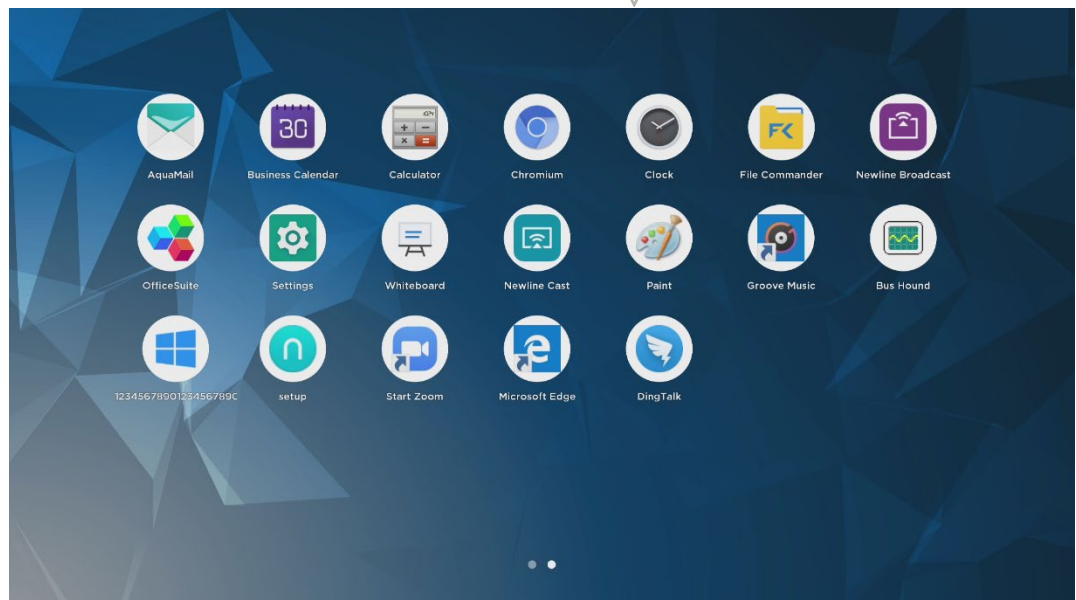

Step 3. In the gadget interface. Tap the icon of an added Windows application to start the software.

6 Quick Setting Menu

Using two fingers to swipe up from the bottom of the screen, the Quick Settings menu will appear, tap wherever outside of the menu to hide the quick setting menu. As shown in the following figure.

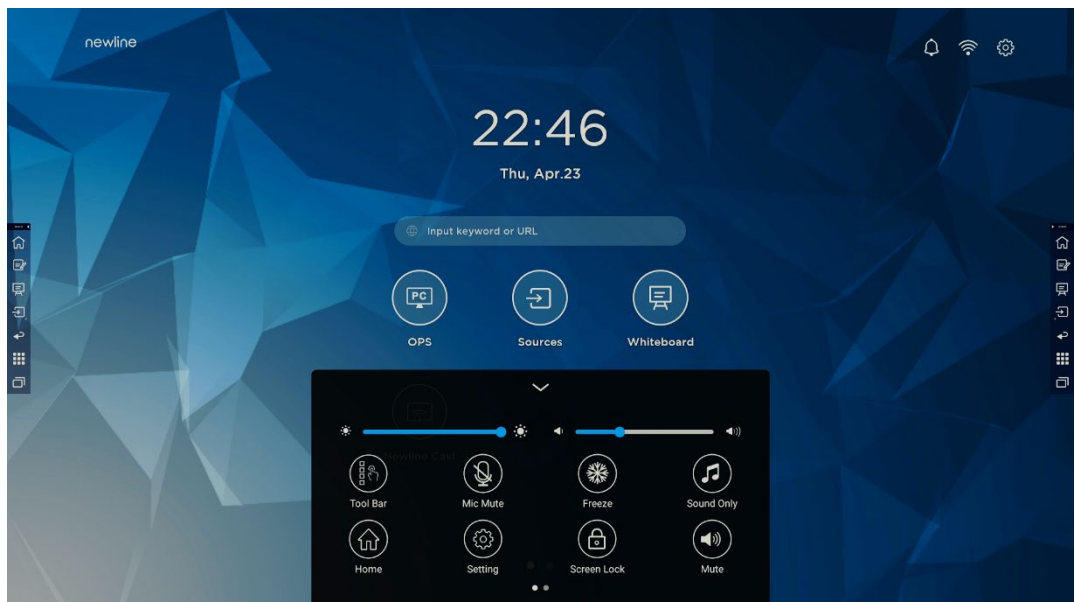





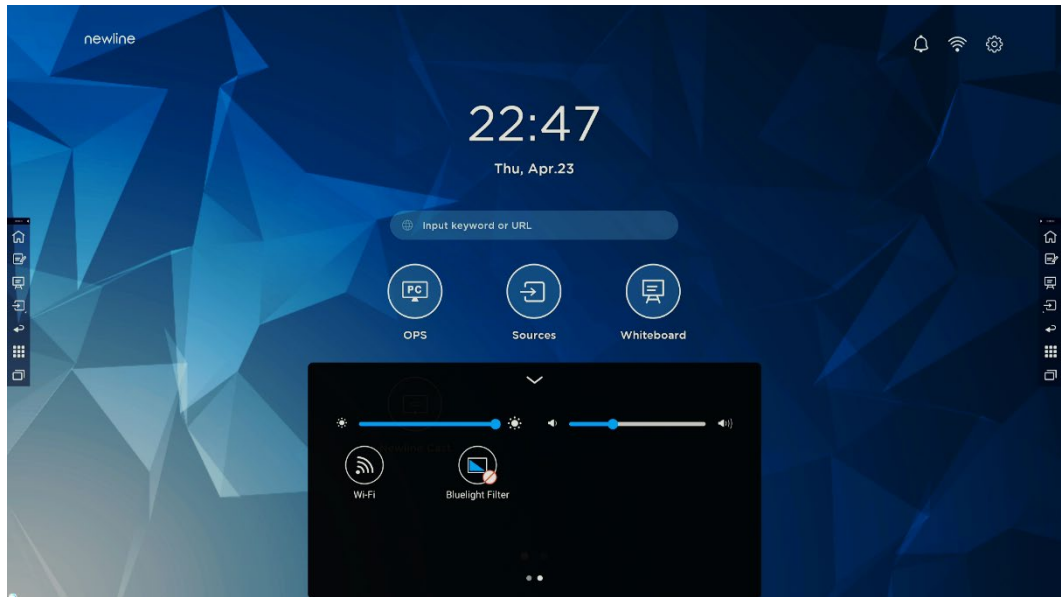







(绘图要求：增加手势从下往上滑出的效果)

In the quick settings menu interface, swipe left or right with your finger to switch the page, as shown in the following figure:



(绘图要求：增加手指在快捷菜单界面左/右滑动的效果)

Icons	Name	Functions
	Brightness	Drag the slider to adjust the brightness.
	Volume	Drag the slider to adjust the volume.
	Toolbar	Tap the icon to turn on/off the toolbar.
	Microphone mute	Tap the icon to mute/unmute Microphone.
	Freeze	Tap the icon to enter/exit freeze function.
	Sound only	Tap the icon to enable sound only mode. In sound only mode, the screen LCD displays and LED backlight turns off, other functions are in normal operating condition.
	Home	Tap the icon to return to Home page.
	Setting	Tap the icon to enter the settings page.

Icons	Name	Functions
	Screen Lock	Tap the icon to enter/exit screen lock function. User can set the temporary passkey for locking the screen.
	Mute	Tap the icon to mute or unmute.
	Wi-Fi	Tap the icon to turn on/off the Smart system Wi-Fi.
	Bluelight Fliter	Tap the icon to turn on/off the blue light filter.

7 D. Mode



CAUTION

- *Please switch off the touch screen when it is not used and enable the function of Sound Only when you do not need to watch the screen, which help reduce power consumption and save energy.*
 - *On the premise of ensuring viewing effect, the energy consumption can be reduced by lowering display brightness.*
 - *To better save energy, the automatic power-off function is configured for the touch screen, users can enter **Settings > Power > Energy Saving** to set the duration.*
-

Press  on the remote controller to enter the D. mode (ECO > Standard > Auto > Custom). Hold the button to switch between the four modes.

- In the **ECO** mode, the power output is reduced 50%, screen brightness is 40% of standard.
- In the **Standard** mode, the screen brightness keeps the same.
- In the **Auto** mode, the screen brightness is 80% of standard.
- In the **Custom** mode, the screen brightness is 80% of standard. Brightness can be adjusted manually.

8 Serial Port Control

RS232 communication cable (please use cross data cables)

PIN	This Device	Computer
1	NC	NC
2	RXDO	TXDO
3	TXDO	RXDO
4	NC	NC
5	GND	GND
6	NC	NC
7	NC	NC
8	NC	NC
9	NC	NC
Cover	GND	GND

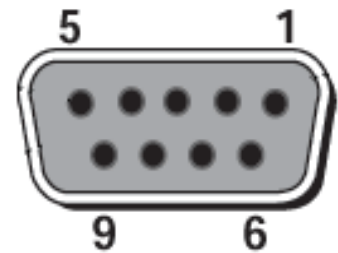

RS232 port of touch screen

Connect the RS-232 port to a computer or central control device, turn on the RS-232 serial port connection, and customize settings as follows.

Port No.: COM1 (set according to the port number of the computers or the central control device)			
Bit Rate	19200	Parity Check	None
Data Bit	8	Stop Bit	1

The button control code is assigned as follows: (TV issues the return code to the serial port after receiving the serial port command, and returns to the host computer)

Functions	Control Codes	Return Codes
Power on	7F 08 99 A2 B3 C4 02 FF 01 00 CF	7F 09 99 A2 B3 C4 02 FF 01 00 01 CF
Power off	7F 08 99 A2 B3 C4 02 FF 01 01 CF	7F 09 99 A2 B3 C4 02 FF 01 01 01 CF
Mute/Unmute toggle	7F 08 99 A2 B3 C4 02 FF 01 02 CF	7F 09 99 A2 B3 C4 02 FF 01 02 01 CF
Mute On	7F 08 99 A2 B3 C4 02 FF 0F 00 CF	7F 09 99 A2 B3 C4 02 FF 0F 00 01 CF
Mute Off	7F 08 99 A2 B3 C4 02 FF 0F 01 CF	7F 09 99 A2 B3 C4 02 FF 0F 01 01 CF
Signal source	7F 08 99 A2 B3 C4 02 FF 01 06 CF	7F 09 99 A2 B3 C4 02 FF 01 06 01 CF
Enable whiteboard	7F 08 99 A2 B3 C4 02 FF 01 07 CF	7F 09 99 A2 B3 C4 02 FF 01 07 01 CF
HDMI front	7F 08 99 A2 B3 C4 02 FF 01 0A CF	7F 09 99 A2 B3 C4 02 FF 01 0A 01 CF
HDMI rear 1	7F 08 99 A2 B3 C4 02 FF 01 52 CF	7F 09 99 A2 B3 C4 02 FF 01 52 01 CF
HDMI rear 2	7F 08 99 A2 B3 C4 02 FF 01 53 CF	7F 09 99 A2 B3 C4 02 FF 01 53 01 CF
Internal PC	7F 08 99 A2 B3 C4 02 FF 01 38 CF	7F 09 99 A2 B3 C4 02 FF 01 38 01 CF
VGA	7F 08 99 A2 B3 C4 02 FF 01 0D 0D CF	7F 09 99 A2 B3 C4 02 FF 01 0D 01 CF
Page up	7F 08 99 A2 B3 C4 02 FF 01 13 CF	7F 09 99 A2 B3 C4 02 FF 01 13 01 CF
Page down	7F 08 99 A2 B3 C4 02 FF 01 14 CF	7F 09 99 A2 B3 C4 02 FF 01 14 01 CF
VOL -	7F 08 99 A2 B3 C4 02 FF 01 17 CF	7F 09 99 A2 B3 C4 02 FF 01 17 01 CF
VOL +	7F 08 99 A2 B3 C4 02 FF 01 18 CF	7F 09 99 A2 B3 C4 02 FF 01 18 01 CF
Menu	7F 08 99 A2 B3 C4 02 FF 01 1B CF	7F 09 99 A2 B3 C4 02 FF 01 1B 01 CF
Home page	7F 08 99 A2 B3 C4 02 FF 01 1C CF	7F 09 99 A2 B3 C4 02 FF 01 1C 01 CF
Return (exit)	7F 08 99 A2 B3 C4 02 FF 01 1D	7F 09 99 A2 B3 C4 02 FF 01 1D 01

Functions	Control Codes	Return Codes
	CF	CF
OK	7F 08 99 A2 B3 C4 02 FF 01 2B CF	7F 09 99 A2 B3 C4 02 FF 01 2B 01 CF
←	7F 08 99 A2 B3 C4 02 FF 01 2C CF	7F 09 99 A2 B3 C4 02 FF 01 2C 01 CF
→	7F 08 99 A2 B3 C4 02 FF 01 2D CF	7F 09 99 A2 B3 C4 02 FF 01 2D 01 CF
↑	7F 08 99 A2 B3 C4 02 FF 01 2E CF	7F 09 99 A2 B3 C4 02 FF 01 2E 01 CF
Set volume	7F 08 99 A2 B3 C4 02 FF 05 XX CF NOTES: XX indicates the volume value (0 to 100), corresponding to hexadecimals 00 to 64.	7F 09 99 A2 B3 C4 02 FF 05 XX 01 CF
Query the firmware version number	7F 08 99 A2 B3 C4 02 FF 01 3D CF	7F 09 99 A2 B3 C4 02 FF 01 3D 01 CF
Set display mode	7F 08 99 A2 B3 C4 02 FF 06 XX CF NOTES: XX indicates the mode. 00=Standard, 01=Eco, 02=Auto, 03= Custom	7F 09 99 A2 B3 C4 02 FF 06 XX 01 CF
Enable the annotation mode	7F 08 99 A2 B3 C4 02 FF 01 40 CF	7F 09 99 A2 B3 C4 02 FF 01 40 01 CF
Microphone mute toggle	7F 08 99 A2 B3 C4 02 FF 01 41 CF	7F 09 99 A2 B3 C4 02 FF 01 41 01 CF
Microphone Mute On	7F 08 99 A2 B3 C4 02 FF 0C 01 CF	7F 09 99 A2 B3 C4 02 FF 0C 01 01 CF
Microphone Mute Off	7F 08 99 A2 B3 C4 02 FF 0C 02 CF	7F 09 99 A2 B3 C4 02 FF 0C 02 01 CF
Increase backlight brightness	7F 08 99 A2 B3 C4 02 FF 01 47 CF	7F 09 99 A2 B3 C4 02 FF 01 47 01 CF
Decrease backlight brightness	7F 08 99 A2 B3 C4 02 FF 01 48 CF	7F 09 99 A2 B3 C4 02 FF 01 48 01 CF
Set the value of backlight brightness	7F 08 99 A2 B3 C4 02 FF 09 XX CF NOTES: XX indicates the value of	7F 09 99 A2 B3 C4 02 FF 09 XX 01 CF

Functions	Control Codes	Return Codes
	backlight brightness (0 - 100), corresponding to the hexadecimal number system (00 - 64).	
Switch backlight	7F 08 99 A2 B3 C4 02 FF 01 15 CF	7F 09 99 A2 B3 C4 02 FF 01 15 XX CF NOTES: XX = 01 indicates the backlight is on. XX = 00 indicates the backlight is off.
Switch Backlight On	7F 08 99 A2 B3 C4 02 FF 0E 01 CF	7F 09 99 A2 B3 C4 02 FF 0E 01 01 CF
Switch Backlight Off	7F 08 99 A2 B3 C4 02 FF 0E 00 CF	7F 09 99 A2 B3 C4 02 FF 0E 00 01 CF
Screenshot	7F 08 99 A2 B3 C4 02 FF 01 1F CF	7F 09 99 A2 B3 C4 02 FF 01 1F 01 CF
Settings	7F 08 99 A2 B3 C4 02 FF 01 20 CF	7F 09 99 A2 B3 C4 02 FF 01 20 01 CF
Freeze ON/OFF toggle	7F 08 99 A2 B3 C4 02 FF 01 3B CF	7F 09 99 A2 B3 C4 02 FF 01 3B 01 CF
Freeze On	7F 08 99 A2 B3 C4 02 FF 0B 00 CF	7F 09 99 A2 B3 C4 02 FF 0B 00 01 CF
Freeze Off	7F 08 99 A2 B3 C4 02 FF 0B 01 CF	7F 09 99 A2 B3 C4 02 FF 0B 01 01 CF
Switch router mode (NAT/Bridge)	7F 08 99 A2 B3 C4 02 FF 03 XX CF NOTES: XX = 01 indicates that the router mode is NAT. XX = 02 indicates that the router mode is Bridge.	7F 09 99 A2 B3 C4 02 FF 03 XX 01 CF
Enable Newline Cast	7F 08 99 A2 B3 C4 02 FF 0B 02 CF	7F 09 99 A2 B3 C4 02 FF 0B 02 01 CF
Close Newline Cast	7F 08 99 A2 B3 C4 02 FF 0B 03 CF	7F 09 99 A2 B3 C4 02 FF 0B 03 01 CF
Enable Newline Broadcast	7F 08 99 A2 B3 C4 02 FF 0B 04 CF	7F 09 99 A2 B3 C4 02 FF 0B 04 01 CF
Close Newline Broadcast	7F 08 99 A2 B3 C4 02 FF 0B 05 CF	7F 09 99 A2 B3 C4 02 FF 0B 05 01 CF

Functions	Control Codes	Return Codes
Power supply	7F 08 99 A2 B3 C4 02 FF 01 37 CF	7F 09 99 A2 B3 C4 02 FF 01 37 XX CF NOTES: 01: power on state 00: power off state
Speaker	7F 08 99 A2 B3 C4 02 FF 01 82 CF	7F 09 99 A2 B3 C4 02 FF 01 82 XX CF NOTES: 01: mute 00: unmute
Current signal source	7F 08 99 A2 B3 C4 02 FF 01 50 CF	7F 09 99 A2 B3 C4 02 FF 01 50 XX CF NOTES: Smart system = 30 PC = 17 HDMI rear 1 = 1F HDMI Rear 2 = 1E HDMI Rear 3 = 18 HDMI Front = 19 TYPEC = 21 VGA=22
Speaker volume	7F 08 99 A2 B3 C4 02 FF 01 33 CF	7F 09 99 A2 B3 C4 02 FF 01 33 XX CF NOTES: XX indicates current volume value (XX is a hexadecimal value, range: 00~64). For example, XX = 20 indicates current volume value is 32 (decimal value), XX = 00 indicates mute state.
D.Mode	7F 08 99 A2 B3 C4 02 FF 01 35 CF	7F 09 99 A2 B3 C4 02 FF 01 35 XX CF NOTES: 00: Standard 01: Eco 02: Auto(VN only) 03: Custom

Functions	Control Codes	Return Codes
Microphone status	7F 08 99 A2 B3 C4 02 FF 01 45 CF	7F 09 99 A2 B3 C4 02 FF 01 45 XX CF NOTES: 01: the microphone is mute. 02: the microphone is not mute.
Backlight brightness	7F 08 99 A2 B3 C4 02 FF 01 49 CF	7F 09 99 A2 B3 C4 02 FF 01 49 XX CF NOTES: XX indicates the value of backlight brightness (0 - 100), corresponding to the hexadecimal number system (00 - 64).
Backlight status	7F 08 99 A2 B3 C4 02 FF 01 81 CF	7F 09 99 A2 B3 C4 02 FF 01 81 XX CF NOTES: 00: backlight is on. 01: backlight is off.
Check to screen lock status	7F 08 99 A2 B3 C4 02 FF 01 84 CF	7F 09 99 A2 B3 C4 02 FF 01 84 XX CF NOTES: 00: screen lock is off. 01: screen lock is on.
Whiteboard status	7F 08 99 A2 B3 C4 02 FF 01 83 CF	7F 09 99 A2 B3 C4 02 FF 01 83 XX CF NOTES: 01: the whiteboard is activated 00: the whiteboard is not activated.
Return to system state of the previous 11 options	7F 08 99 A2 B3 C4 02 FF 0A 00 CF	7F 13 99 A2 B3 C4 02 FF 0A 00 AB CD EF GH IJ KL MN OP QR ST UV CF NOTES: AB: Power supply CD: Speaker EF: Current signal source GH: Speaker volume IJ: D.Mode KL: microphone

Functions	Control Codes	Return Codes
		MN: camera position OP: backlight brightness QR: backlight state ST: Whiteboard state UV: Switch to child safety lock

9 VGA Signal Input Specifications

VGA (Video Graphics Array) is a computer display standard for analog signals. The VGA port is a dedicated VGA standard computer data output port. The table below lists the specifications of VGA signal input.

No.	Standard	Resolution	Refresh rate (Hz)
1	VGA	720 x 400	70Hz
2	VGA	800 x 600	60Hz (VESA)
3	VGA	800 x 600	72Hz (VESA)
4	VGA	1280 x 1024	75Hz (VESA)
5	VGA	1280 x 1024	60Hz
6	VGA	1920 x 1080	60.00 Hz (recommended)
7	VGA	1360 x 768	60.02 Hz

10

Formats Supported by Multi-media

Multimedia type	Format
Photo	JPEG, PNG, BUMP, GIG
Video	VP9, VP8, MJPEG
Audio	PCM, FFMPEG_ADEC, ADPCM, APE, FLAC, ALAC, TTA, MIDI, MP3, BLURAYLPCM, OGG VORBIS, WAVEPACK

11 Troubleshooting

Before contacting a service technician, please conduct an inspection according to the following table. If the problem can't be solved by following the suggested steps, please contact your local dealer. For your safety, do not repair the machine on your own.

Issue	Solution
The machine can't be properly turned on / the indicator is off	<ul style="list-style-type: none"> • Check whether the power socket is connected to the power source. • Check whether the power plug is properly plugged in. • Check whether the power line is in poor condition. • Check whether the rocker switch has been turned on.
Automatically turn on/off when unused	<ul style="list-style-type: none"> • Turn off the automatic power on/off function. • Check whether the device has been idle for a significant period and therefore the machine has entered sleep mode. • Check whether the input power is stable.
No image display	<ul style="list-style-type: none"> • Check whether the power cord is connected to an electrical outlet and whether the power is turned on. • Check whether the rocker switch of the machine has been turned on. • Check whether the power is turned on. • Check whether the input computer is correctly connected. • Check whether the input source is correct.
The image is normal, but there is no sound	<ul style="list-style-type: none"> • Check the volume. • Check whether the mute button on the remote control has been pressed. • Check whether the mute function in the menu is turned on.
Image or sound is disturbed	<ul style="list-style-type: none"> • Find interfering electrical equipment nearby and move it away from the machine. • Do not share the same power outlet with interfering electrical equipment.
Remote control failure	<ul style="list-style-type: none"> • Replace the battery. • Clean the transmission port in the top of the remote control (check whether it is blocked). • Check whether the batteries are poorly installed.
Image color is abnormal	<ul style="list-style-type: none"> • Check whether the HDMI cable is connected properly. • Check whether the VGA cable is connected properly.
There is no touch control under external source channel	<ul style="list-style-type: none"> • Try switching between different external sources. • Make sure that the USB cable is connected to the correct interface. For details, see the "Rear Port" section. • Re-plug the USB cable.

Issue	Solution
Built-in computer has no signal	<ul style="list-style-type: none"> • Check whether the built-in computer is properly inserted into the slot. • Check whether the built-in computer is in sleep mode. • Press the power button on the built-in computer (refer to the built-in computer manual for details) and turn it on manually.
Built-in computer can't be turned on	<ul style="list-style-type: none"> • Check whether the computer and the machine are properly connected. • Replace the built-in computer.
Pen shakes (jitters) when writing	The use of a Smooth pen is recommended. Hold the Smooth pen far away from the tip and keep the angle between the Smooth pen and the screen surface greater than 60° (keep your sleeve or wrist away from the screen surface).
	Remove sources of interference or change to an environment without interference.
Strokes are intermittent when writing (only certain part allows writing)	The use of a Smooth pen is recommended. Hold the Smooth pen far away from the tip and keep the angle between the Smooth pen and the screen surface greater than 60° (keep your sleeve or wrist away from the screen surface).
	Replace the tip or write with a larger occlusion area.
	Check whether there is any foreign object on the infrared strip.
	Remove sources of interference or change to an environment without interference.
Unable to write	Replace with a different colored pen.
	The use of a Smooth pen is recommended. Hold the Smooth pen far away from the tip and keep the angle between the Smooth pen and the screen surface greater than 60° (keep your sleeve or wrist away from the screen surface).
	Remove sources of interference or change to an environment without interference.
	The use of a Smooth pen is recommended. Hold the Smooth pen far away from the tip and keep the angle between the Smooth pen and the screen surface greater than 60° (keep your sleeve or wrist away from the screen surface).

The following conditions are not failures:

- Since the panels require precise production technology, there may be very few pixels that are bright or dark, such as tiny red, blue and green spots (bright spots) on the screen, or dark spots on some screens. This isn't malfunction and will not affect the overall performance of the machine.
- The machine will make a slight noise due to backlight adjustment or heat dissipation. This phenomenon is normal.
- When the projected image and audio sounds are normal, static energy may be felt by touching the screen and the metal back cover.

 **NOTE**

Because the machine is not optical bonding type, so in the case of high temperature difference and high humidity, the inside of the screen glass may fog, this phenomenon can be removed by running the machine continuously for about three hours.

12 Maintenance

Daily Maintenance

- Do not install or place the machine near a heat source, or place it in direct sunlight, in a dusty or humid environment, or where there is mechanical vibration or shock. To ensure performance, keep it away from high voltage, transmission grid, large metal objects, radar stations and other equipment.
- Do not wipe the body with chemical agents, as the chemicals may cause the cover to deteriorate or cause damage to the surface paint. If there is dust or dirt, turn off the power and wipe it with a soft cloth. Wipe the touch screen gently with a clean soft cloth.
- Do not switch the machine on and off frequently, as this will affect the machine's service life. After a normal shutdown, please wait at least three minutes before turning it back on. If it is not to be used for a long period of time, please turn off the power and unplug the power cord.
- Do not set the brightness and contrast to the maximum value for extended periods of time as this affects the service life of the screen.
- Do not write on the touch screen with any hard object in order to avoid scratching.

Infrared Strip Cleaning

The machine utilizes an infrared matrix in the horizontal and vertical directions to detect and locate the user's touch. There are infrared strips (i.e., IR receiving tubes and IR transmitting tubes) around the screen, which form an optical net made of infrared rays on the surface of the screen. When you touch the screen, fingers or other opaque objects will block the horizontal and vertical infrared rays that pass through the point, and the controller will determine the coordinate position of the point.

Due to the long-term exposure to the air, the surface of the screen is extremely easy to accumulate dust, resulting in insensitive touch or inaccurate positioning. Therefore, the infrared strips around the screen should be cleaned regularly.

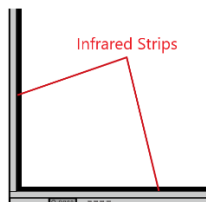

13

Technical Parameter

Specification	Parameter		
Model	TT-6520ER	TT-7520ER	TT-8620ER
Display			
Backlight Type	LED		
Aspect Ratio	16:9		
Physical Resolution	3840 x 2160 Pixel		
Degree of color	8 Bit	8 Bit	10 Bit
Loudspeaker			
Location	Bottom		
Maximum Power Output	2 x 15 W		
Touch			
Material of Touch Surface	Tempered glass		
Touch Sensing Technology	IR		
Touch Points	20 points		
Writing Points	Thick pen 8mm; Fine pen 3mm		
Writing Instrument	Pens, Finger, Opaque object		
Power Dissipation / Transportation / Storage			
Stand-by Power Consumption	≤0.5W		
Working Voltage	100V ~ 240V, 50Hz/60Hz		
Storage Temperature/Humidity	-10°C ~ 45°C / 20% ~ 90% (Non coagulation)		
Working Temperature/Humidity	0 °C ~ 40 °C / 20% ~ 80% (Non coagulation)		
Installation Method	Wall-mount or Stand		

Specification	Parameter		
Model	TT-6520ER	TT-7520ER	TT-8620ER
Rated Power	≤ 300W	≤ 400W	≤ 450W
Rated Current	Max 3A	Max 4A	Max 4.5A
Display Area length×width (mm)	1428.48×803.52 mm	1650.24×928.36 mm	1895.04×1065.96 mm
Boundary Dimension (length × width × the thickness of the bare / With hanging) (mm)	1514.7×916.8×96 /114.2 mm	1736.6×1040.7×97.1 /132.1 mm	1982.6×1180.5×97.2 /132.1 mm
Package Size	1640*221*1036 mm	1859*247*1160 mm	2119*275*1281 mm
Net Weight	40KG	55KG	70KG
Gross Weight	49KG	67KG	86.5KG
Other Functions			
Internal Wi-Fi	2.4G/5G (Support for WIFI and hotspot co-existence)		
Android System			
RAM	3 GB		
Flash	64 GB		
Multimedia file format	Supports most popular multimedia file formats		
Android Software			
The Android Version	8.0.0		
Function	Support screen annotation, whiteboard, wireless screen, check in, vote and other functions.		

For more machine information, please visit:

<https://newline-interactive.com/apac/technical-support/>

The company is committed to machine updates and technical improvements. The technical parameters and specifications are subject to change without prior notice. The pictures in this manual are for reference only.