

newline



RS Plus Series

V2.0

Quick Start Manual

Welcome to the world of **NEWLINE**.

Thank you for choosing the **NEWLINE RS** series Interactive Touch Screen. Please use this document to get the most out of your screen.

This device complies with part 15 of the FCC Rules. Operation is subject to the following two conditions:(1) This device may not cause harmful interference, and (2) this device must accept any interference received, including interference that may cause undesired operation.

NOTE 1: This equipment has been tested and found to comply with the limits for a Class B digital device, pursuant to part 15 of the FCC Rules. These limits are designed to provide reasonable protection against harmful interference in a residential installation. This equipment generates, uses and can radiate radio frequency energy and, if not installed and used in accordance with the instructions, may cause harmful interference to radio communications. However, there is no guarantee that interference will not occur in a particular installation. If this equipment does cause harmful interference to radio or television reception, which can be determined by turning the equipment off and on, the user is encouraged to try to correct the interference by one or more of the following measures:

- Reorient or relocate the receiving antenna.
- Increase the separation between the equipment and receiver.
- Connect the equipment into an outlet on a circuit different from that to which the receiver is connected.
- Consult the dealer or an experienced radio/TV technician for help.



NOTE 2: Any changes or modifications to this unit not expressly approved by the party responsible for compliance could void the user's authority to operate the equipment.

The symbol of the crossed out wheeled bin indicates this product should not be placed in municipal waste. Instead, dispose of waste equipment by handing it over to a designated collection point for the recycling of electrical and electronic equipment.







Symbol Conventions

Symbols are used in this document to indicate operations that need particular attention. The symbols are defined as follows:

 NOTE	Provides additional information to supplement operation in the main text.
 CAUTION	Indicates a potentially hazardous situation that, if not avoided, could result in equipment damage, data loss, performance deterioration, or unanticipated results.
 WARNING	Indicates a hazard with risk that, if not avoided, could result in death or injury.

Safety Instruction

For your safety, please read the following instruction before you use the product. Serious injury or property damage may be caused by improper operations. Do not try to repair the product on your own.

 WARNING	
	<p>Disconnect the product from the power supply immediately if major failures occur. Major failures include the following:</p> <ul style="list-style-type: none"> • If smoke, a peculiar smell or an abnormal sound is discharged from the product. • No image or sound is displayed, or the image error occurs. <p>In the preceding scenarios, do not continue to use the product. Disconnect power supply immediately and contact professional staff for troubleshooting.</p>
	<p>Do not drop any liquids, metal or anything combustible onto the product.</p> <ul style="list-style-type: none"> • If any liquid or metal are dropped onto or into the product, power off the product and disconnect the power supply, Then contact professional staff for solutions. • Pay attention to children when they are close to the product. <p>Put the product on a stable surface. An unstable surface includes, and is not limited to an inclined plane, a shaky stand, desk or platform, that might cause the product to turnover and be damaged.</p>
	<p>Do not open the panel or change the product on your own. High voltage components are installed in the product. When you open the panel , high voltage, electric shock, or other dangerous situations may occur. If inspection, adjustment, or maintenance is required, contact the local distributor for help.</p>
	<p>Use the provided power supply.</p> <ul style="list-style-type: none"> • To prevent the product from being damaged, do not use any types of power cables other than the one provided with the product. • Use a three-wire socket and ensure that it is properly grounded. • Pull out the power plug from the socket if the product is not used for a long period. <p>Clean the power plug regularly.</p> <ul style="list-style-type: none"> • Fire or electric shock may be caused if the product is powered on, while you are cleaning. • Pull out the power plug before cleaning it with a dried cloth. <p>Power output port is 5V/2A The voltage/current of the rear power output port is 5 V/2 A (maximum). Purchase the power code/AC adapter according to customer needs. Please do not connect any products with different power requirement. Otherwise, it may cause damage to products or fire.</p>



WARNING

	<p>Do not put items on the top of the product.</p> <ul style="list-style-type: none">• Do not put items, such as a container for liquid (a vase, flowerpot, cosmetics or liquid medicine) on the top of the product.• If any water or liquid is spilled on the product, the product may short circuit cause fire or electric shock.• Do not walk on or hang any items on the product.
	<p>Do not install the product in an improper place.</p> <ul style="list-style-type: none">• Do not install the product in humid places, such as the bathroom, the shower room, near windows, or outdoor environments that experience rain, snow or other harsh weather. Avoid installation near hot spring vapor. The preceding environments may cause faults in the product or electric shock under extreme conditions.• Do not put an exposed fire source, such as a lit candle on the product.
	<p>Pull out the power supply during thunderstorms.</p> <ul style="list-style-type: none">• Do not touch the product during a lighting storm, you may experience an electric shock.• Install or place components that supply high enough voltage to cause personal injury out of the reach of children.
	<p>Do not touch the power cable with wet hands.</p>



CAUTION

	<p>Do not install the product in high temperature environments.</p> <ul style="list-style-type: none">• Do not install the product near a heat source, such as a radiator, a heat reservoir, a stove or other heating products.• Do not expose the product to direct sunlight, which may cause high temperatures and subsequent faults in the product.
	<p>When transporting the product:</p> <ul style="list-style-type: none">• Pack the product for transport or maintenance by using the cartons and cushioning material provided with the product.• Move the product vertically during transport. The screen or other components are easily broken if the product is moved in an improper way.• Before you move the product, disconnect all external connections and separate all topple preventing products. Move the product carefully to prevent it from being hit or squeezed, especially the screen, which may cause injury if broken.
	<p>Do not cover or block up any vents on the product.</p> <ul style="list-style-type: none">• Any overheated components may cause fire, damage the product, and shorten the service life.• Do not lay the product down in a way where the venting surface will be covered.



CAUTION

- Do not install the product on carpet or cloth.
- Do not use a cloth such as table cloth to cover the product.



Keep the product away from the radio.

The product complies with the international EMI standard to prevent radio interference. However, interference may still exist and cause noise in the radio. If noise occurs in the radio, try the following solutions.

- Adjust the direction of the radio antenna to avoid the interference from the product.
- Keep the radio away from the product.

If the screen glass is broken or falls off.

- Keep all personnel 10 feet away from the screen to ensure safety.
- Do not perform any installation or disassembly while the screen glass is broken or has fallen off.

Use the battery correctly.

- Galvanic corrosion, electric leakage, and even fire may be caused by improper battery usage.
- It is recommended to use the designated type of battery and install the battery by the correct electrodes (positive and negative).
- Do not install and use a new battery with a used one.
- Take out the battery if the remote control is not used for a long period.
- Do not expose the battery to overheated environments, such as sunlight and other heat sources.
- Dispose of the used battery based on your local regulations.

Do not damage the power cable.

- Do not damage, change, twist, bend, or forcibly drag the power cable.
- Do not put weights (such as the product itself) on the power cable.
- Do not forcibly drag the cable when you pull out the power plug. If the power cable is damaged, please contact the local distributor to repair or replace it.
- The power cable in the accessory box is for this product only. Do not use it on other products.

Additional advice:

- Use the product in an environment with comfortable lighting. It is harmful to your eyes to watch in a too bright or too dark environment.
- Relax your eyes watching for a period of time.
- Keep sufficient distance from the product to protect your eyes and prevent eyestrain.
- Adjust the volume to an appropriate level, especially at night.
- Use amplifier equipment as the audio input source with caution. If you must use amplifier equipment, the input power should not exceed the maximum of speaker power. Otherwise, the speaker can become overpowered and damaged.

About USB port.

Front USB ports and rear USB 3.0/USB 2.0 ports switch connections based on signal sources. If the current signal source is reading the data from an external product connecting to the port, please switch the signal source after the data reading is complete. Otherwise, the data or product



CAUTION

may be damaged.

1 Parts and Functions

1.1 Parts

- Front View

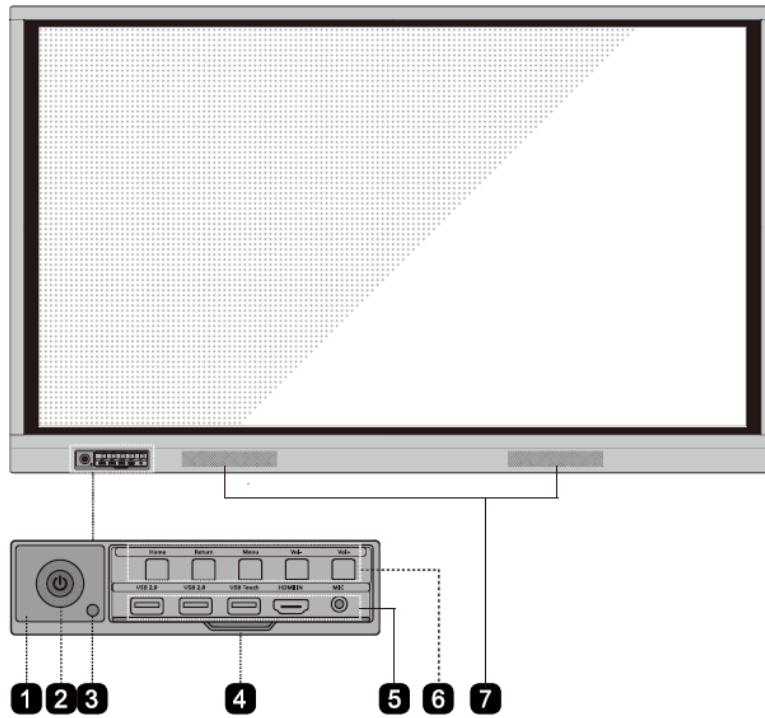

- Rear View

65 INCH:

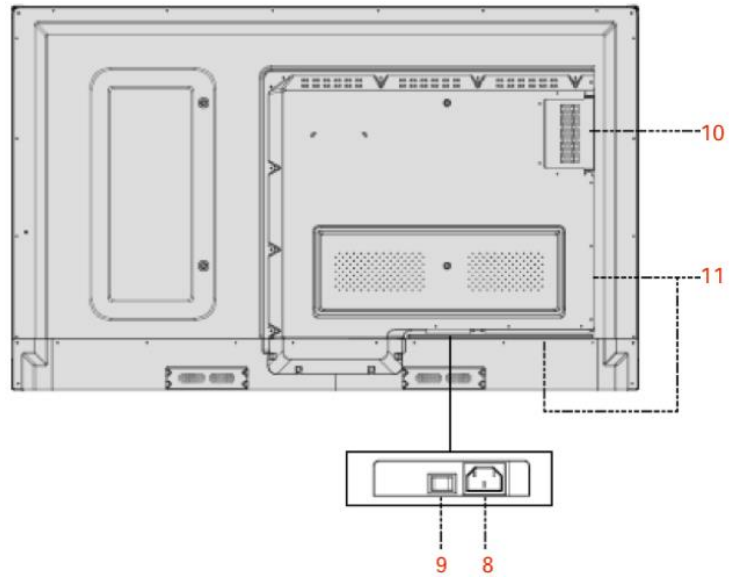

75 INCH/86 INCH:

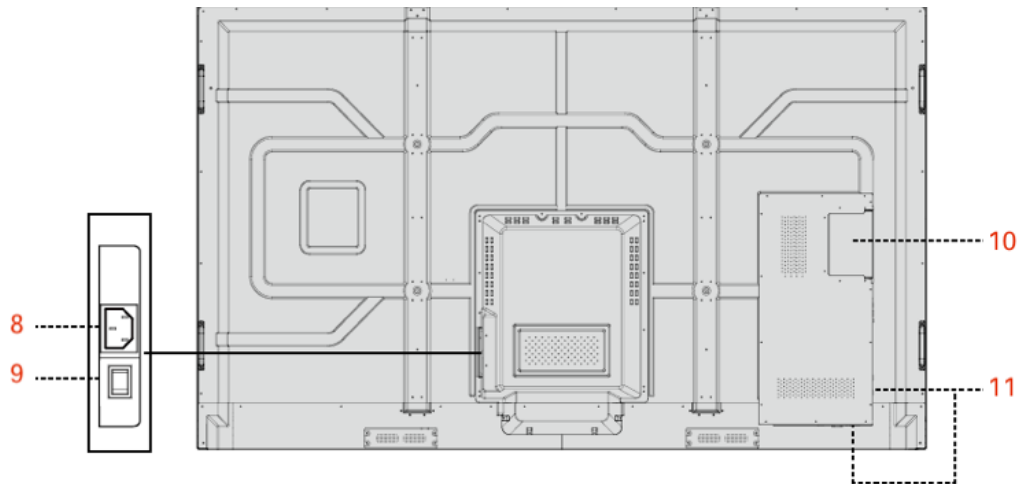

1	Remote Control Receiver	7	Speakers
2	Power On/Off	8	Power Supply Plug
3	Light Sensor	9	Power Switch
4	Front Plate Cover	10	Internal PC Port (OPS)
5	Front Ports	11	Rear Ports

6	Front Buttons		
---	---------------	--	--

1.2 Ports



CAUTION

- *Front USB ports and rear USB 3.0/USB 2.0 ports switch connections based on signal sources. If the current signal source is reading the data from an external product connecting to the port, please switch the signal source after the data reading is complete. Otherwise, the data or product may be damaged.*
- *For USB consumption, USB 2.0 provides up to 500ma whereas USB 3.0 provides up to 900ma. Kindly please make sure your USB flash drive which inserts to the display port is FAT32 format.*

-
- Front Ports

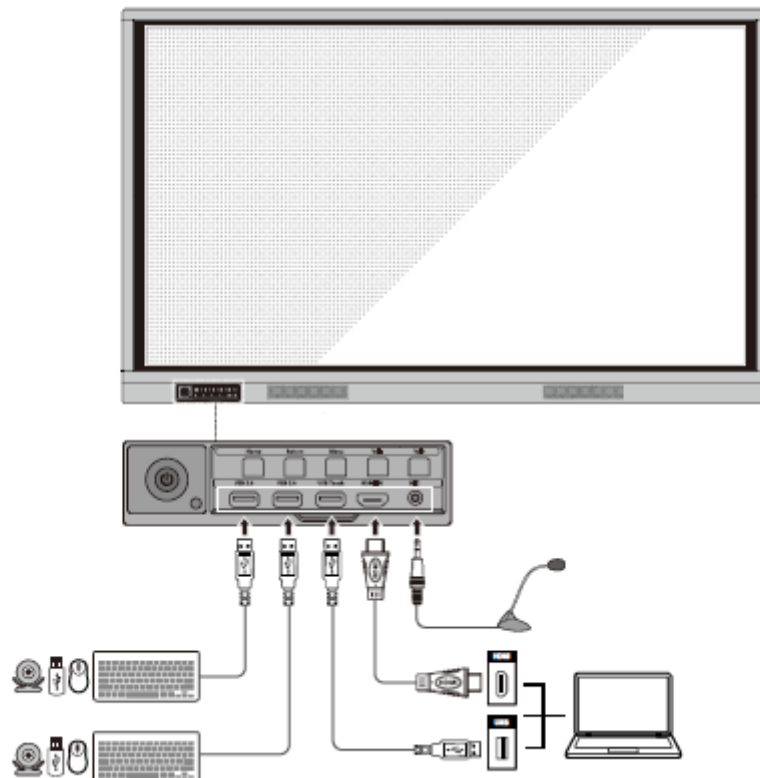

- Rear Ports

- Front Buttons



















Buttons	Operations	Functions
	Short press	Power on/off <ul style="list-style-type: none"> • Steady red color : Display is in shut down mode • Steady white color : Display is on and working
Home	Short press	Go to the home page
Return	Short press	Return to the last menu/Exit
Menu	Short press	Open the Settings menu
	Long press for more than 2 seconds	Lock the screen
Vol-	Short press	Decrease the sound volume
	Long press for more than 1 second	Continuously decrease the sound volume
Vol+	Short press	Increase the sound volume
	Long press for more than 1 second	Continuously increase the sound volume

1.3 Remote Control







Carefully read the following instructions before using the remote control to avoid possible faults:

- Do not drop or damage the remote control.
 - Do not spill water or other liquids on the remote control.
 - Do not place the remote control on a wet object.
 - Do not place the remote control directly under sunlight or near a heat source.
-

Buttons	Operations
	Power On/Off
	Mute/Unmute Audio
0-9	Enter number
	Go to the Home Page
	Return to Previous/Exit
	Up/Down/Left/Right
	Confirm/OK
	Enter Whiteboard Mode
	Take a Screenshot
	Enable Sound Only Mode
	Freeze the Current Screen, Click Again to Exit Freeze Function
	Adjust the Sound Volume
	Adjust the Brightness
	Enter the Source Selection Page
	View Currently Running Applications
	Open the File Manager
	View all Pre-installed Applications
PC	Switch Source to Internal PC
DP	Switch Source to Display Port
HDMI FRONT	Switch Source to HDMI Front
HDMI 1	Switch Source to HDMI 1
HDMI 2	Switch Source to HDMI 2
VGA	Switch Source to VGA
	Autocorrection Screen Display (For VGA Signal Source)



Buttons	Operations
	Open the Browser Application
	Toggle Display Backlight Mode
	Start/Exit the Screen Lock Function
	<ul style="list-style-type: none"> • Open the Menu (Short Press) • Screen Lock (Long Press for More than 2 Seconds)
	Open the System Settings

(排版要求：排版时请将此表格排同一页，保证美观和方便阅读。)

2 Installation Guide

2.1 Safety Precautions

Installation Environment



Installation Direction

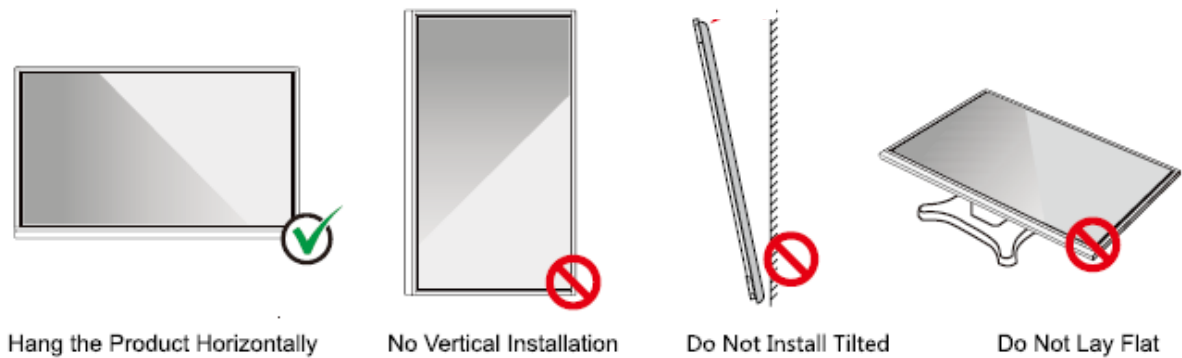

2.2 Installation Precautions

Weight Loading

Weight of the product: 161lb/ 73 kg (86INCH), 123lb/56 kg (75INCH), 99lb/ 45kg (65INCH)

- When using a mobile stand, ensure that the weight of the product is less than the loading capacity of the mobile stand.
- When using the wall-mount bracket, ensure that the wall can support the weight of the product. We recommend that the wall surface be reinforced and have a loading capacity 4 times of the weight of the product. Consult a professional installer for wall-mount installation.

NOTE

The company does not undertake relevant legal responsibility for any problems caused by improper operation, if the third party mobile stand, or wall-mount bracket is beyond the scope of the product.

- Do not install the product where it might be hit by an opening or closing door.

Vertical installation

When installing, try to keep the product vertical. An excessive tilt angle may cause the screen glass to fall off or the product to collapse.

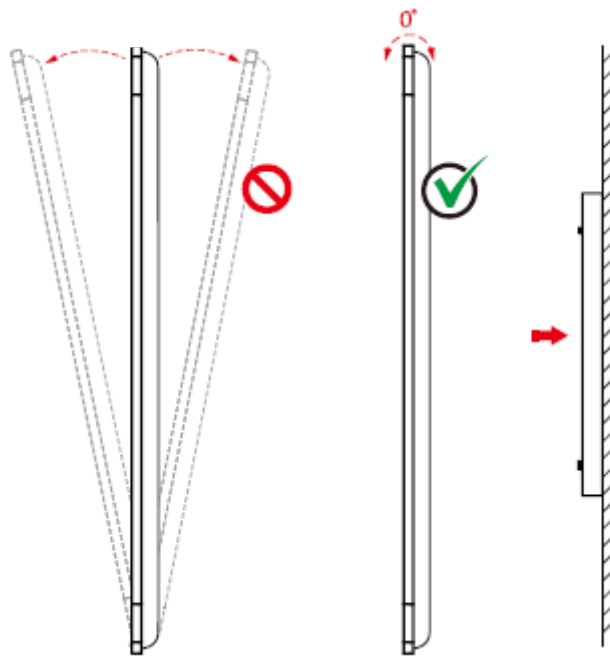

NOTE

For any problem, please contact our support desk. Our company is not responsible for any damage or losses incurred by users if the users fails to follow the instructions.

Ventilation

Ensure adequate ventilation and/or an air conditioned environment. We recommend keeping certain distances from the side of the product to the wall or panels. Ventilation requirements are shown in following figure.

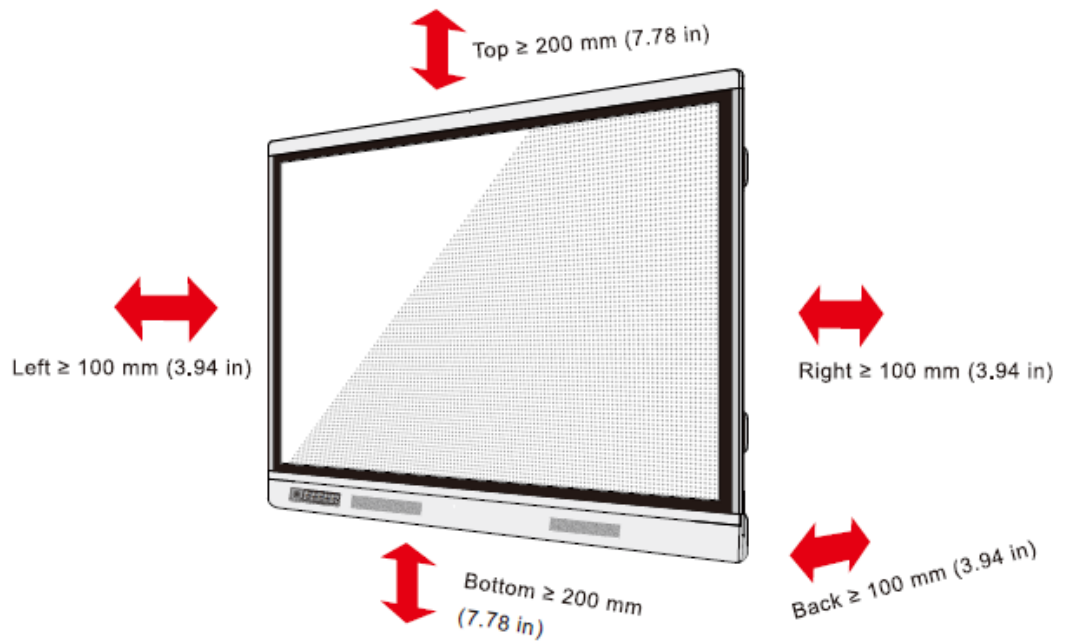

2.3 Installation

The dimensions of the four bracket mounting holes on the back panel are VESA MIS-Fcompliant (86INCH or 75INCH: 800 x 400 mm/31.50 x 15.75 in; 65INCH: 600 x 400 mm/23.62 x 15.75 in). Use metric M8 screws with a length of 10 mm to 15 mm (0.40 to 0.59 in) to secure the touch screen to the mountingsystem. Dimensions of the mounting holes on the back panel are shown on the following figure.

NOTE

Consult a professional installer to install the display product.

75INCH/86INCH:

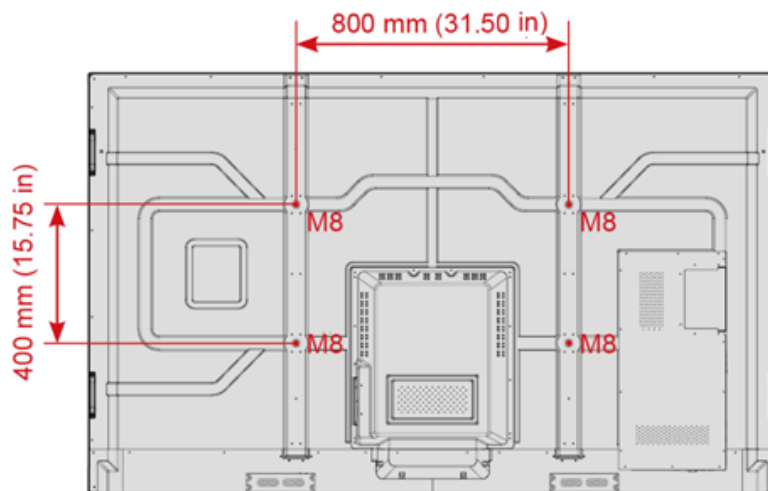

65INCH:

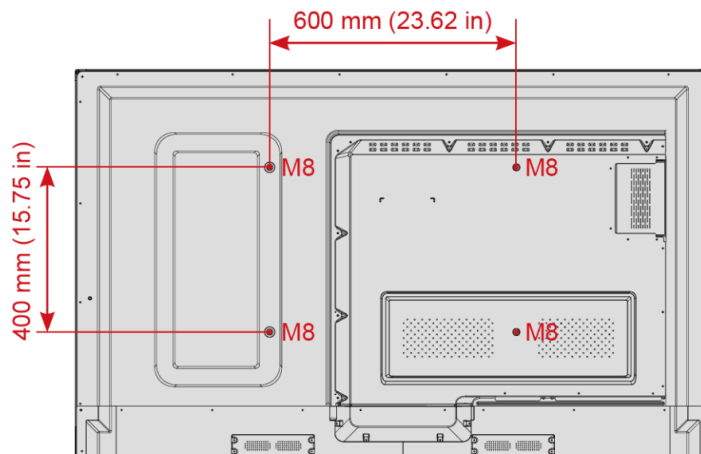

2.4 Installing the Internal PC (Optional)

 **CAUTION**

The internal PC does not support hot plugging. Therefore, you must insert or remove the internal PC when the display is powered off. Otherwise, the display or internal PC may be damaged.

You will need to purchase the internal PC separately. Perform the following steps to install the internal PC.

Step 1 Unscrew the M3 screws by hand to remove the internal PC shielding cover.

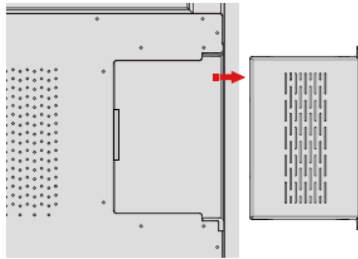

Step 2 Push the internal PC into the internal PC port at the rear of the panel from right to left.

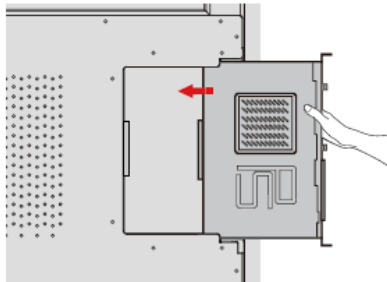

Step 3 Secure the internal PC to the display by using the M3 screws.

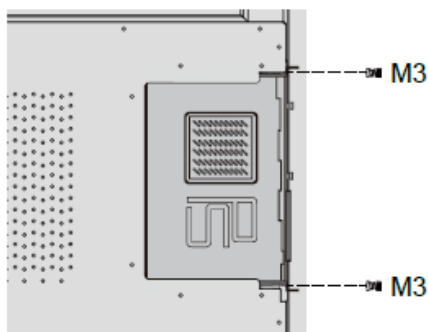

Step 4 Ensure the installation is correct before turning the power on again.

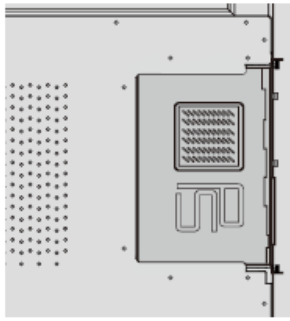

3 Turning On/Off

3.1 Power On

Step 1 Plug the power supply into the power outlet fully and plug the power connector into the side of the product. Ensure the power supply is in the range of 100V to 240V with frequency at 50 Hz/60 Hz \pm 5%. The power current must be grounded.



NOTE

The power outlet should be installed near the equipment and should be easily accessible.

Step 2 Flip the power switch located on the side of the product to “On”.

75INCH/86INCH:

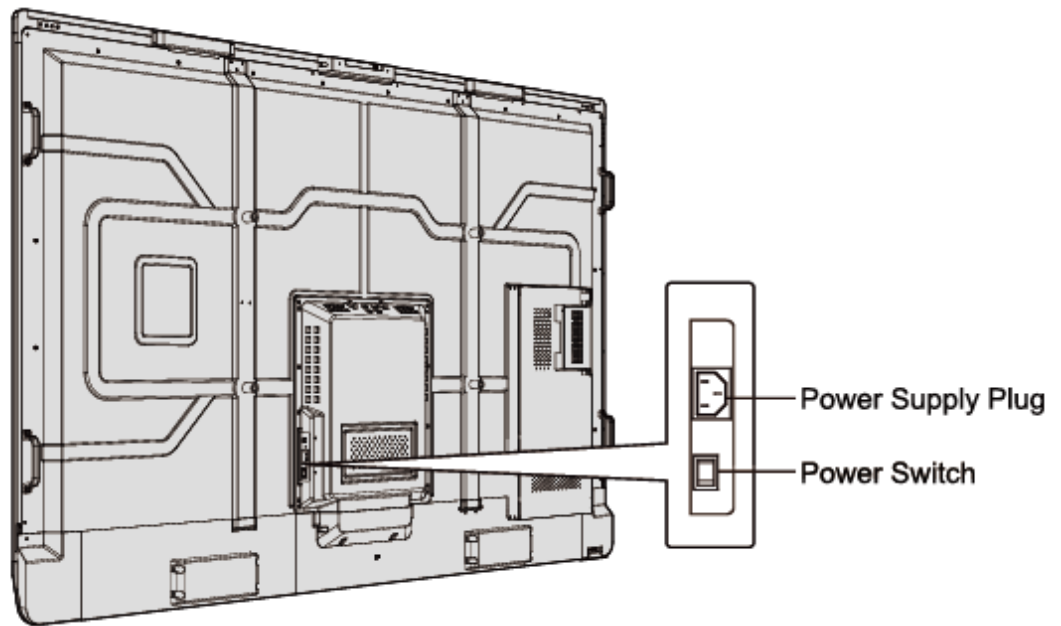

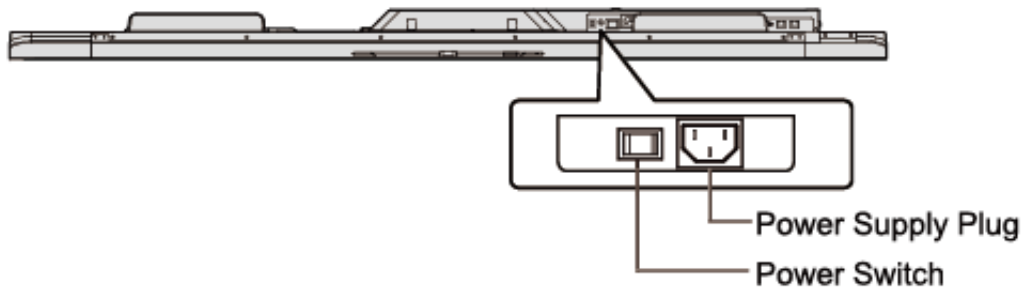

65INCH:





Step 3 Press the power button  on the front control panel or  on the remote control.

3.2 Power Off

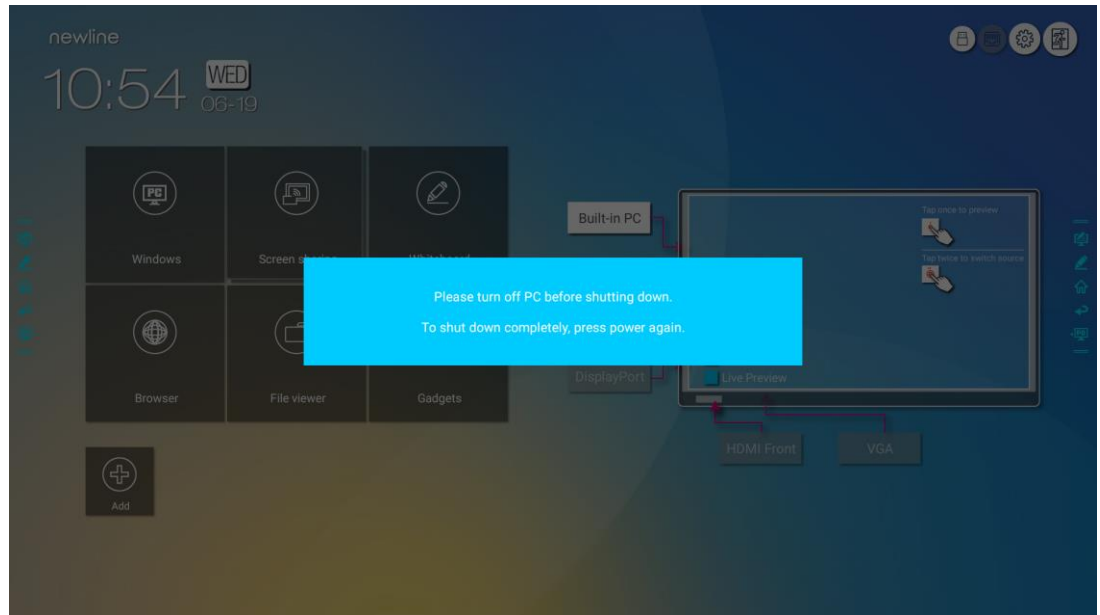
Step 1 Press the power button  on the front panel or the power button  on the remote control. when an internal PC is equipped, the information will be displayed as shown in the following figure.



Step 2 Press the power button  on the front panel or the power button  on the remote control again, the power indicator will turn to red.

Step 3 If you are not going to use the product for an extended period of time, we recommend you switch the power switch to “Off”.

 **NOTE**

- If an internal PC is equipped, the internal PC and the screen are powered off simultaneously when you power off the display.
- Do not forcibly disconnect the power supply of the display when the internal PC is on.

4 Operating the Touch Screen

4.1 Start Screen

When the product is turned on, the product will show the Start Screen page, as shown in the following figure:

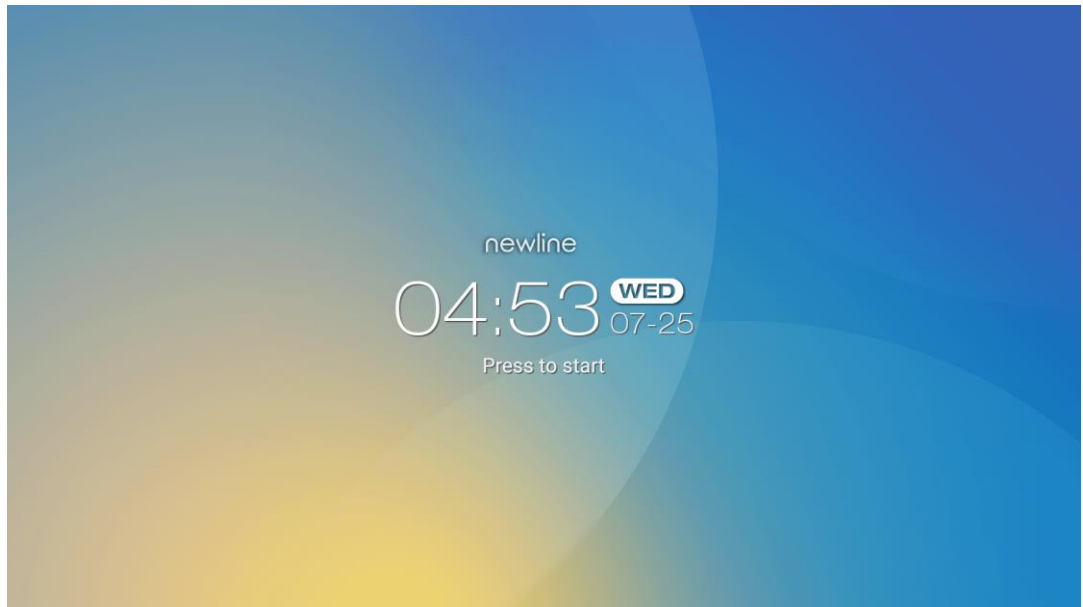





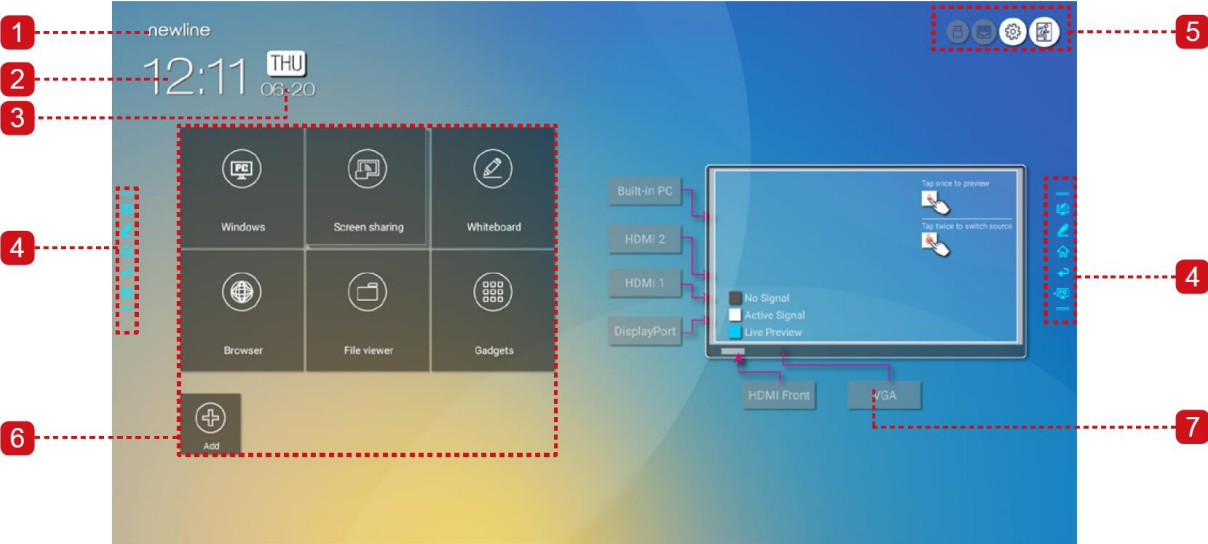



4.2 Home

Touch anywhere on the Start Screen to start a meeting, and the product will go to the **Home** page, as shown in the following figure:



- 1: Logo (Shortcut to Settings) 2: Clock (Shortcut to Clock)
- 3: Date and Week 4: Side Toolbar 5: Status Bar and Settings
- 6: Main Icon 7: Preview Window for Signal Source

Main Icon

Icon	Functions
	Switch to the internal PC source.
	Click “Screen Sharing” to enable the wireless screen sharing function. Note: By default, the “ Screen sharing ” icon is displayed after startup. When you click “ Add ” or “ Gadget ” icon, “ Screen sharing ” switches to the “ Connection ” icon.
	Click Connection to view the connected sources, including Built-in PC, HDMI 1, HDMI 2, DisplayPort, HDMI Front and VGA.
	Whiteboard takes you to the whiteboard function and screen annotation functions.
	Click to enter a quick-access browser.
	Open the File Manager to explore internal and external files on the display.
	Gadget displays all pre-installed applications, including Browser, Music, Calculator, E-mail, File Viewer, Office Viewer and Newline Cast... etc. Click the icon of an application to run the application.
	Click Add to customize the Home page. You can add up to 5 shortcuts to your favorite software, gadgets or connections. (See more detail in “Add Shortcuts to Home Page”)





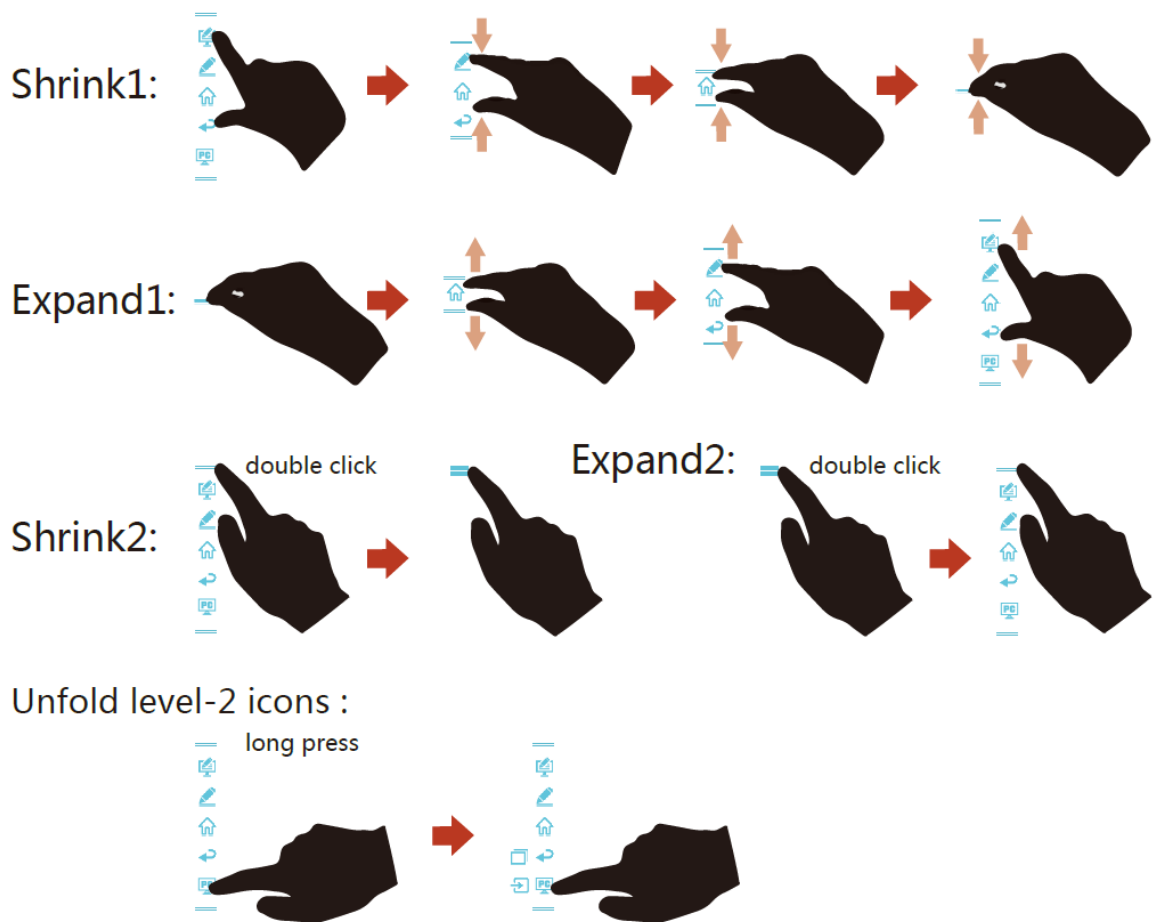

Side Toolbar

The Annotation Mode, Whiteboard, Home, Return, and Windows icons are displayed by default in the toolbar on both sides of the screen. You may hide one or both side toolbars in the Settings or move it up and down on the screen, shrink or expand by using touch gestures.

You may double-tap the “=” to expand or shrink the toolbar. Long press the  icon to unfold level-2 icons.







The functions of the side toolbar are as follows:

Icon	Functions
	Enter annotation mode, and click again to stop annotation and take a screenshot.
	Access whiteboard mode.
	Go to Home page.
	Return to the previous menu/Exit an app.
	Go to the internal PC source.
	Manage currently running applications. Slide up/down the currently running application or click “x” at the upper right corner to close the application.

Icon	Functions
	Go to your favorite source. You can set favorite source in the “ tool bar ” submenu in the system settings.

Status Bar and Settings

The upper right corner of the home page displays three working status icons (including USB drive(s), Ethernet, and Wi-Fi), system setting shortcut and return to the start screen page.

Icon	Functions
	If USB drive is connected to the USB port, this icon will appear.
	If the product is connected to Ethernet, the icon will appear.
	If the product is connected to a wireless network, the icon will appear.
	Access the system setting page.
	Return to the Start Screen page.



5 Add Shortcut

5.1 Add Shortcuts to Home Page

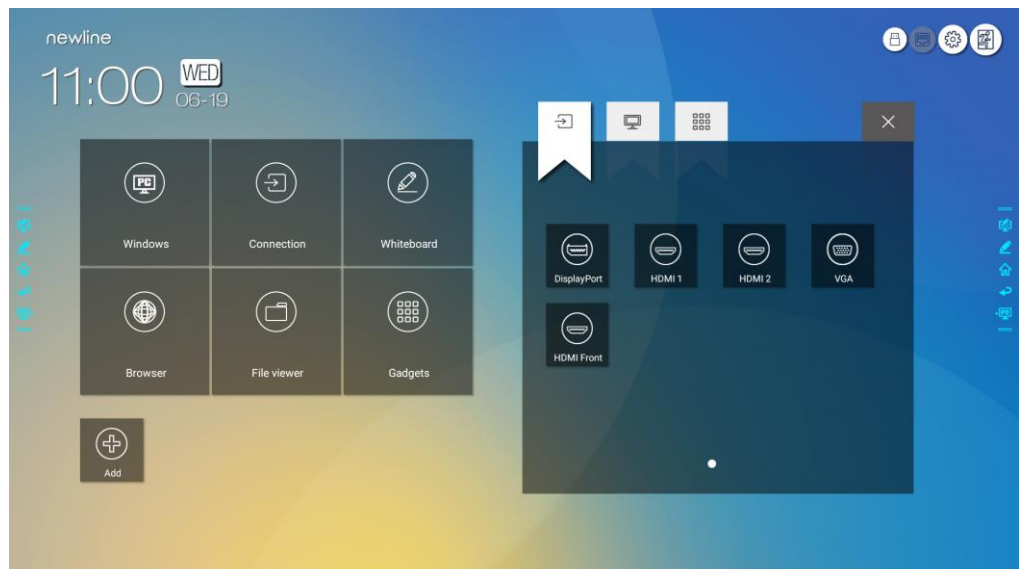
Step 1 On **Home** page, click the  icon in the lower right corner. The interface for adding shortcuts will be displayed.



Step 2 Click the icons on top to switch the list between external signal sources, Windows software shortcuts and pre-installed gadgets.

- Click  to view signal sources in **Connection**.
- Click  to view the Windows software shortcuts that the Newline Assistant uploads to the embedded operating system. For details, see “Add Quick Start Windows Programs in Smart System”.

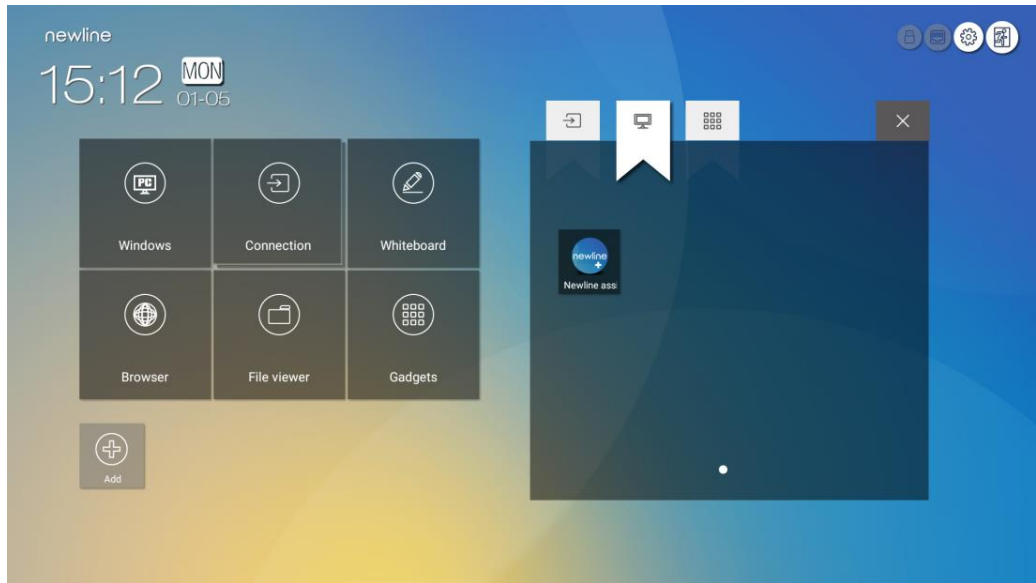

- Click  to view all Gadget applications.

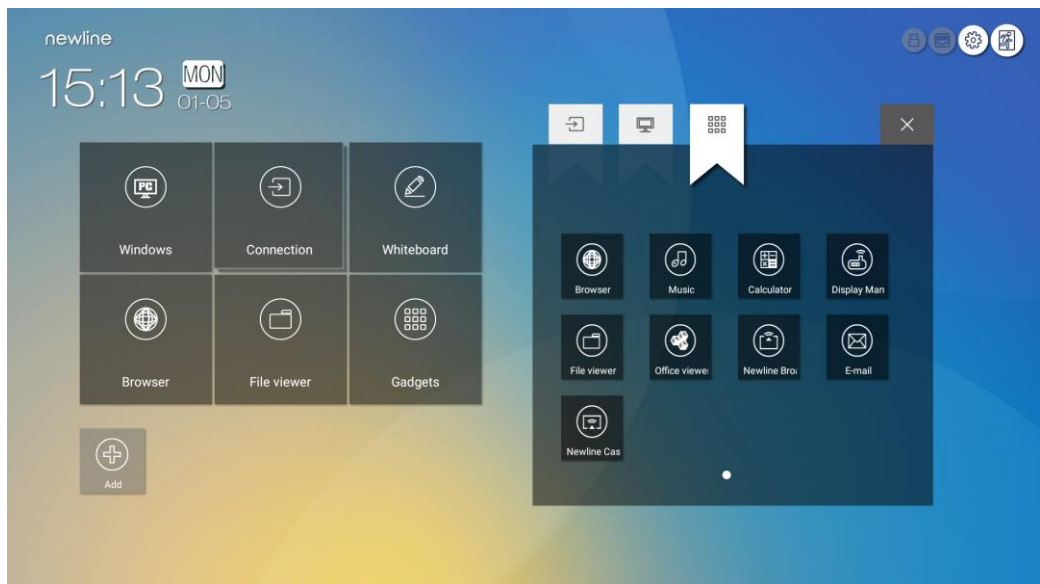

Step 3 Add or delete applications on the tab.

- In the list, click the icon to add it as a shortcut on the Home page. A check icon will appear at the upper right corner of the shortcut icons. Up to 5 shortcuts can be added.
- Tap the icon with the check mark again. The check icon will disappear and the shortcut will be removed from the **Home** page.

Step 4 At the **Home** page, click the shortcut icon and you can start the program/application or change to the external signal source.

5.2 Newline Assistant

5.2.1 Introduction

The Newline Assistant is the tool used as a bridge between the embedded operating system and the Internal PC (OPS). It helps add Windows software shortcut to the Home Page, as well as to protect USB data when switching between sources.

Therefore we strongly recommend users install the Newline Assistant after installing the internal PC.

5.2.2 Installation

- Step 1** Connect Internal PC correctly (See also "**Error! Reference source not found.**").
- Step 2** On the **Home Page**, click **Windows**. It will switch the signal source to the Internal Windows system.
- Step 3** Visit our website at www.newline-interactive.com and choose **Products > RS series > download** to download the Newline Assistant installation package.
- Step 4** Install the Newline Assistant as instructed.



5.2.3 Add Quick Start Windows Programs in Smart System

- Step 1** In Windows, run the **Newline Assistant** program and drag the software icons or folder shortcut icons that you want to add from the desktop or menu to the **Newline Assistant** window. The applications added or deleted through the Windows system will be automatically updated to the embedded operating system until the upload progress reaches 100%. If there is an application not updated, click  in the upper right corner to manually update all icons in the Newline assistant window to the smart system.

TIP

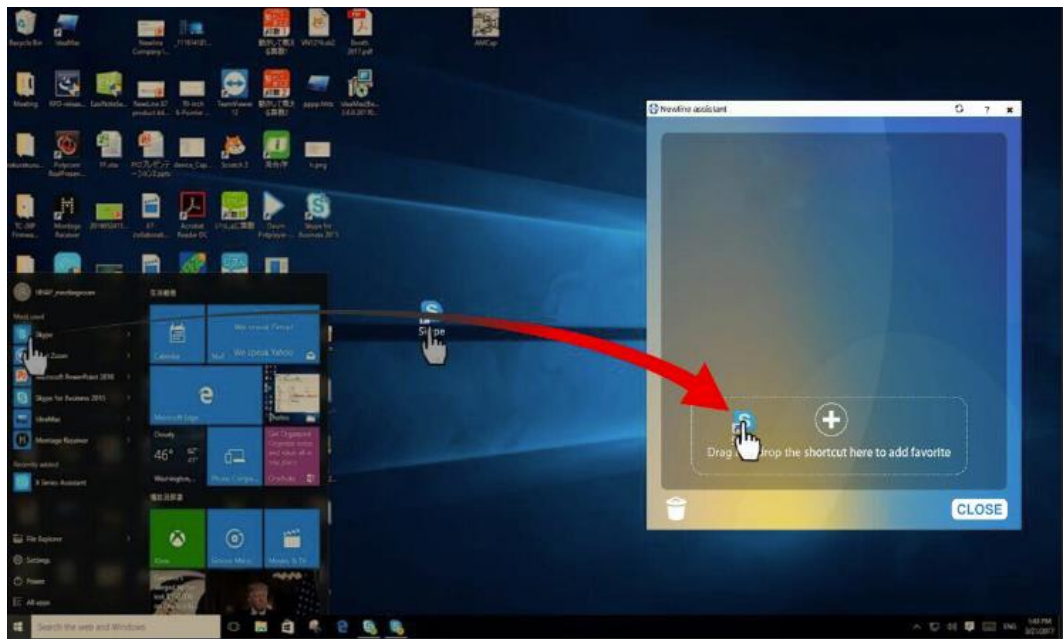
Only folders and .exe file are supported.



Step 2 Click  to return to the **Home** Page. Click the  icon and go to the shortcut setting. The page for adding application programs will be displayed.

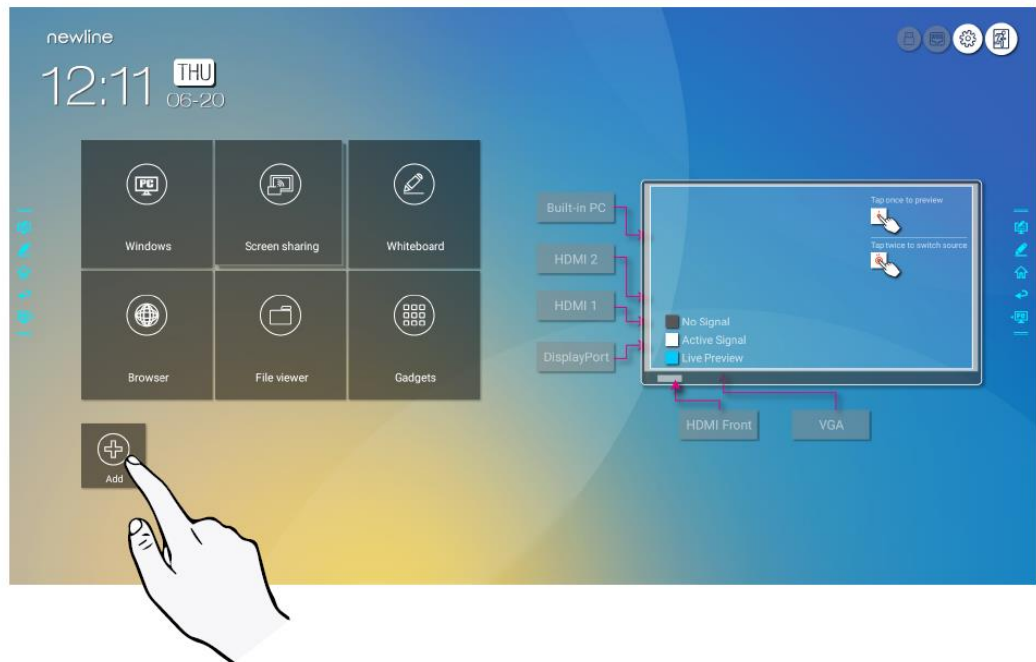

Step 3 At the shortcut setting page, click  icon to view all the Windows software shortcuts added by the Newline Assistant in Step 1.

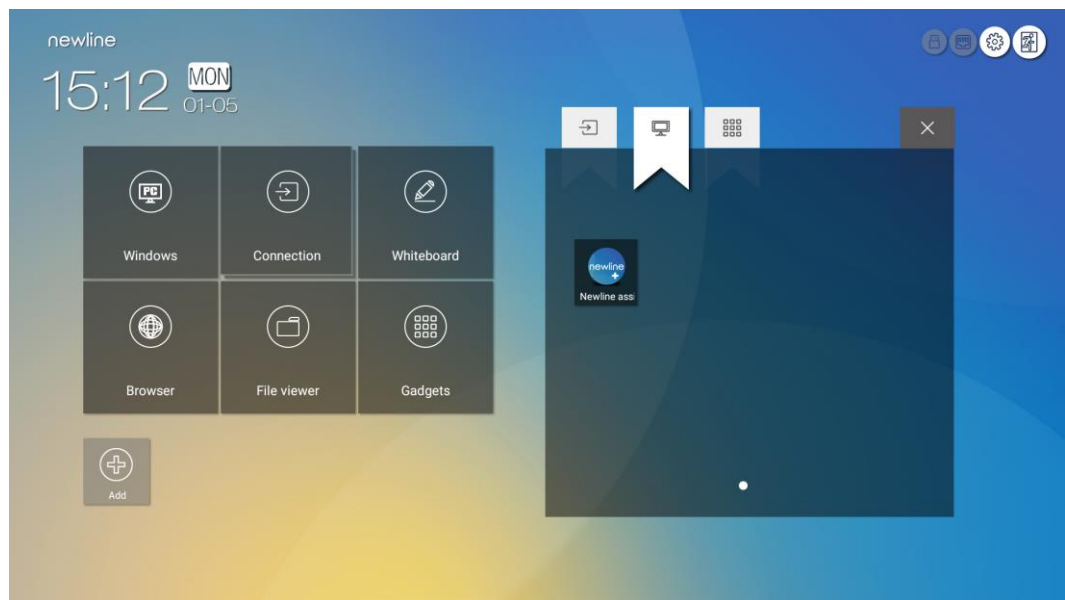

 **NOTE**

By default, the Newline Assistant application is added on the  tab.

Step 4 Tap the icon and add the shortcut at the Home page. Tap again and remove it.

Step 5 Return to **Home** page. Click the icon of an added Windows application to start the software.

6 Quick Setting Menu



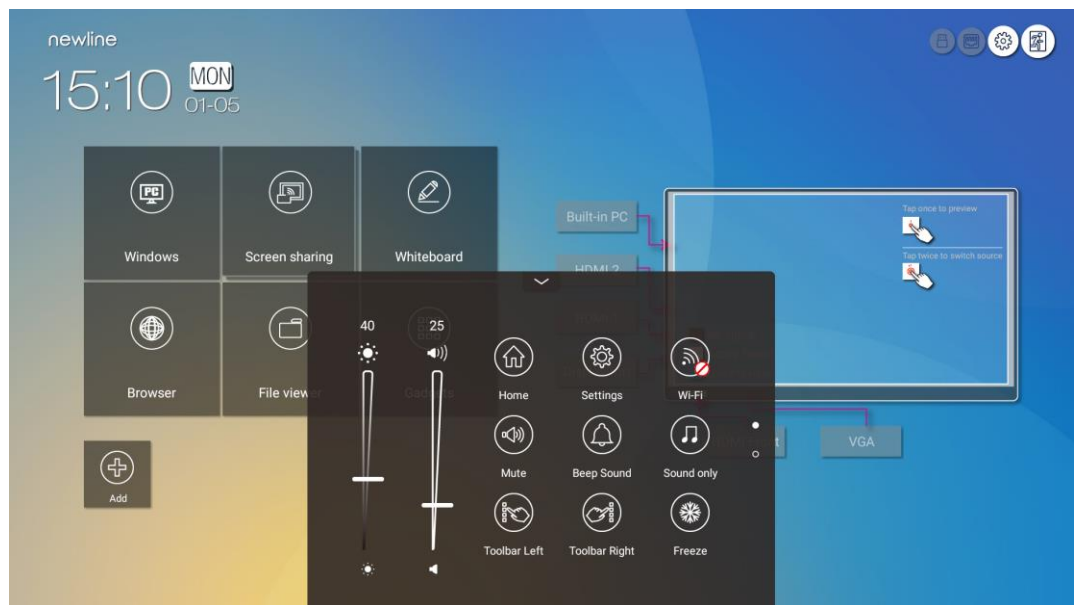





Using two fingers to swipe up from the bottom of the screen, the Quick Settings menu will appear, as shown in the following figure.





(绘图要求：参照下图绘制手势图替换上图)



(绘图要求：手势需优化)

Icon	Functions
	Drag the slider to adjust the brightness.
	Drag the slider to adjust the volume.
	Click the icon to return to Home page.
	Click the icon to enter the settings page.
	Click the icon to turn on/off the Smart system Wi-Fi.
	Click the icon to mute/unmute.
	Click the icon to turn on/off the beep sound.
	Click the icon to enable sound only mode. In sound only mode, the screen LCD displays and LED backlight turns off, other functions are in normal operating condition.

Icon	Functions
	Click the icon to turn on/off the left toolbar.
	Click the icon to turn on/off the right toolbar.
	Click the icon to turn on/off the screen freeze function.

7 More Information

For More Information

Please visit our website (www.newline-interactive.com) for detailed instruction manual.

Contact Us for Support

Please email us at support@newline-interactive.com.

Our company is devoted to product innovation and technology enhancement. Therefore, we may change product specs and information without notice, Product pictures in the manual are for reference only, please refer to actual products.