

newline

# Unified Collaboration Display

## TT-6519PTC/ TT-7519PTC/ TT-8619PTC

### User's Manual

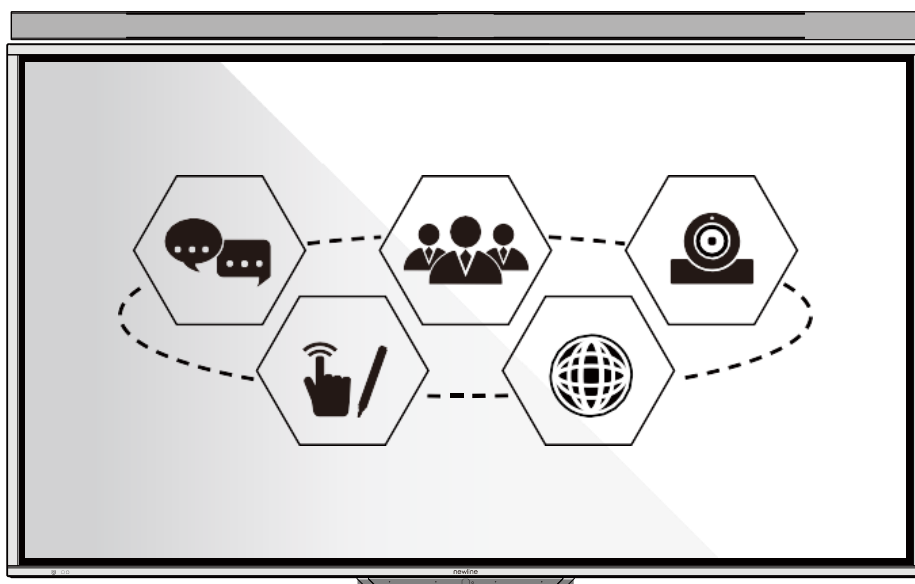

**V2.2 – Firmware version v2.8.9**

Please keep this Manual properly for future reference!

This manual is a general manual, the pictures are for reference only, please refer to the real product.

## Welcome:

Thanks for purchasing this machine. Please read the instructions carefully before using this machine.

---

This symbol of the crossed out wheeled bin indicates this machine should not be placed in municipal waste. Instead, dispose of waste equipment by taking it to a designated collection point for electrical and electronic equipment recycling.



# Contents

---

<b>Contents .....</b>	<b>1</b>
<b>Symbol Convention .....</b>	<b>1</b>
<b>Safety Instructions.....</b>	<b>2</b>
<b>1 Product Overview .....</b>	<b>6</b>
1.1 Product Introduction .....	6
1.2 Appearance Introduction.....	7
Front View .....	7
Rear View.....	8
1.3 Front Control Panel.....	9
1.4 Rear Port .....	10
1.5 Soundbar Top Button .....	12
1.6 Remote Control.....	133
1.6.1 Range of Remote Control .....	155
<b>2 Installation Guide .....</b>	<b>166</b>
2.1 Safety Precautions .....	166
2.2 Weight Loading .....	177
2.3 Ventilation.....	188
2.4 Installing the Built-in Computer.....	199
2.5 Installing the SoundBar .....	20
<b>3 Turning On /Off .....</b>	<b>222</b>
3.1 Power On .....	222
3.2 Power Off .....	233
3.3 Indicator Status .....	233
<b>4 Basic Operation .....</b>	<b>244</b>
4.1 Home .....	244
4.2 Status Bar .....	245
4.3 Floating Bar .....	245
4.3.1 Task Management Sidebar .....	266
4.4 Bottom Toolbar .....	28
4.4.1 View and Hide Bottom Toolbar .....	29
4.4.2 Edit Bottom Toolbar.....	29
4.5 More – App List Interface .....	31
4.5.1 Newline Assistant .....	41
4.6 Screen Off .....	55

**5 Applications ..... 35**



- 5.1 Floating Bar and Bottom Toolbar – Default Applications .....55
  - 5.1.1 Whiteboard & Screen Annotation .....36
    - 5.1.1.1 Whiteboard .....36
    - 5.1.1.2 Screen Annotation .....39
  - 5.1.2 Source .....67
    - 5.1.2.1 Wired Projection .....41
    - 5.1.2.2 Wireless Screen Sharing .....42
  - 5.1.3 File Commander .....79
  - 5.1.4 Windows .....55
  - 5.1.5 More .....55
  - 5.1.6 My USB .....56
- 5.2 More (App List Interface) – Default Application .....85
  - 5.2.1 Camera .....86
  - 5.2.2 Calculator .....86
  - 5.2.3 Signage .....60
  - 5.2.4 Sign In .....87
  - 5.2.5 Vote .....688
  - 5.2.6 Settings .....67
  - 5.2.7 Browser .....68
  - 5.2.8 Whiteboard .....68
  - 5.2.9 Wireless Screen Sharing .....91
  - 5.2.10 Meeting Minutes .....69
  - 5.2.11 OfficeSuite .....71
  - 5.2.12 Clock .....74
  - 5.2.13 Aquamail .....75
  - 5.2.14 Calendar .....76
  - 5.2.15 File Commander .....77
- 5.3 Task Management Sidebar Tool – Default Application .....78
  - 5.3.1 Screenshot .....79
  - 5.3.2 Record (Voice Recording) .....81
  - 5.3.3 Screen Recording .....83
- 5.4 Settings .....85
  - 5.4.1 Network .....86
  - 5.4.2 Application Notification .....86
  - 5.4.3 Display .....87
  - 5.4.4 Volume .....87
  - 5.4.5 Scheduled Power-on/off .....88
  - 5.4.6 Personal Settings .....89
  - 5.4.7 System Space .....90
  - 5.4.8 System Settings .....90
  - 5.4.9 Restore Factory Settings .....91

- 6 Serial Port Control ..... 92**
- 7 Signal Input Specifications ..... 94**
  - 7.1 VGA Signal Input Specifications ..... 94
  - 7.2 HDMI/OPS Signal Input Specifications ..... 94
  - 7.3 HDMI outputs TIMING that can be supported ..... 95
  - 7.4 Type-C Port ..... 95
- 8 Formats Supported by Multi-media.....996**
- 9 Troubleshooting ..... 97**
- 10 Maintenance .....100**
- 11 Technical Parameter.....101**

# Symbol Convention





---







Symbols are used in this document to indicate operations that require special attention. The symbols are defined as follows:

 <b>WARNING</b>	Indicates a hazard with the risk that, if not avoided, could result in death or injury.
 <b>CAUTION</b>	Indicates a potentially hazardous situation that, if not avoided, could result in equipment damage, data loss, performance deterioration, or unanticipated results.
 <b>NOTE</b>	Provides additional information to supplement operation in the main text.



## Safety Instructions

For your safety, please read the following instruction before you use the machine. Serious injury or property damage may be caused by improper operations. Do not try to repair the machine on your own.

 <b>WARNING</b>	
	<p><b>Disconnect the machine from the power supply immediately if major failures occur.</b></p> <p>Major failures include the following:</p> <ul style="list-style-type: none"> <li>□ Smoke, peculiar smell, or abnormal sound is discharged from the machine.</li> <li>□ No image or sound is displayed, or the image error occurs.</li> <li>□ Where the mains plug or an appliance coupler is used as the disconnect device the disconnect device shall remain readily operable.</li> </ul> <p><i>In the preceding scenarios, do not continue to use the machine. Disconnect the power supply immediately and contact professional staff for troubleshooting.</i></p>
	<p><b>Do not drop liquid, metal, or anything combustible into the machine.</b></p> <ul style="list-style-type: none"> <li>□ If any liquid or metal is dropped into the machine, power off the machine, and disconnect the power supply, then contact professional staff for solutions.</li> <li>□ Pay attention to children when they are close to the machine.</li> </ul> <p><b>Put the machine on a stable surface.</b></p> <p><i>An unstable surface includes and does not limited to an inclined plane, a shaky stand, desk, or platform, which might cause turnover and damage.</i></p>
	<p><b>Do not open the cover or change the machine on your own.</b></p> <p><i>High voltage components are installed in the machine. When you open the cover, high voltage, electric shock, or other dangerous situations may occur.</i></p> <p><i>If inspection, adjustment, or maintenance is required, contact the local distributor for help.</i></p>
	<p><b>Use the specified power supply.</b></p> <ul style="list-style-type: none"> <li>□ To prevent the machine from being damaged, do not use any cables other than the one provided with the machine.</li> <li>□ Use a three-wire socket and ensure that it is properly grounded.</li> <li>□ Pull out the power plug from the socket if the machine is not used for a long period.</li> </ul>

	<p><b>Clean the power plug regularly.</b></p> <ul style="list-style-type: none"> <li>□ Continued use of this machine may cause fire or electric shock if the plug is not clean for a long time.</li> <li>□ Pull out the power plug before cleaning it with a dried cloth</li> </ul>
	<p><b>Do not put items on the top of the machine.</b></p> <ul style="list-style-type: none"> <li>□ Do not put items, such as a container for liquid (a vase, flowerpot, cosmetics, or liquid medicine) on the top of the machine.</li> <li>□ If any water or liquid is spilled on the machine, the machine may short circuit and cause fire or electric shock.</li> <li>□ Do not walk on or hang any items on the machine.</li> </ul>
	<p><b>Do not install the machine in an improper place</b></p> <ul style="list-style-type: none"> <li>□ Do not install the machine in humid places, such as the bathroom, the shower room, near windows, or outdoor environments that experience rain, snow, or other harsh weather. Avoid installation near hot spring vapor. The preceding environments may cause faults in the machine or electric shock under extreme conditions.</li> <li>□ Do not put an exposed fire source, such as a lit candle, on the machine.</li> </ul>
	<p><b>Pull out the power supply during thunderstorms.</b></p> <ul style="list-style-type: none"> <li>□ Do not touch the machine during a lightning storm, you may experience an electric shock.</li> <li>□ Install or place components that supply high enough voltage to cause personal injury out of the reach of children.</li> </ul>
	<p><b>Do not touch the power cable with wet hands.</b></p>
 <b>CAUTION</b>	
	<p><b>Do not install the machine in high-temperature environments.</b></p> <ul style="list-style-type: none"> <li>□ Do not install the machine near a heat source, such as a radiator, a heat reservoir, a stove, or other heating machines.</li> <li>□ Do not expose the machine to direct sunlight, which may cause high temperatures and subsequent faults in the machine.</li> </ul>
	<p><b>When transporting the machine:</b></p> <ul style="list-style-type: none"> <li>□ Pack the machine for transport or maintenance by using the cartons and cushioning material provided with the machine.</li> <li>□ Move the machine vertically during transport. The screen or other components are easily broken if the machine is moved in an improper way.</li> </ul>



	<ul style="list-style-type: none"> <li>□ Before you move the machine, disconnect all external connections, and separate all topple preventing machines. Move the machine carefully to prevent it from being hit or squeezed, especially the screen, which may cause injury if broken</li> </ul>
	<p><b>Do not cover or block up any vents on the machine.</b></p> <ul style="list-style-type: none"> <li>□ Any overheated components may cause fire, damage the machine, and shorten the service life.</li> <li>□ Do not lay the machine down in a way where the venting surface will be covered.</li> <li>□ Do not install the machine on carpet or cloth.</li> <li>□ Do not use a cloth, such as table cloth, to cover the machine</li> </ul>
	<p><b>Keep the machine away from the radio.</b></p> <p>The machine complies with the international EMI standard to prevent radio interference. However, interference may still exist and causes noise on the radio. If noise occurs on the radio, try the following solutions.</p> <ul style="list-style-type: none"> <li>□ Adjust the direction of the radio antenna to avoid interference from the machine.</li> <li>□ Keep the radio away from the machine.</li> </ul> <hr/> <p><b>Do not damage the power cable.</b></p> <ul style="list-style-type: none"> <li>□ Do not damage, change, twist, bend, or forcibly drag the power cable.</li> <li>□ Do not put weights (such as the machine itself) on the power cable.</li> <li>□ Do not forcibly drag the cable when you pull out the power plug. If the power cable is damaged, please contact the local distributor to repair or replace it.</li> <li>□ The power cable in the accessory box is for this machine only, do not use it on other machines.</li> </ul> <hr/> <p><b>Use the battery correctly.</b></p> <ul style="list-style-type: none"> <li>□ Galvanic corrosion, electric leakage, and even fire may be caused by improper battery usage.</li> <li>□ It is recommended to use the designated type of battery and install the battery by the correct electrodes (positive and negative).</li> <li>□ Do not install and use a new battery with a used one.</li> <li>□ Take out the battery if the remote control is not used for a long period.</li> <li>□ Do not expose the battery to overheated environments, such as sunlight or heat sources.</li> <li>□ Dispose of the used battery based on your local regulations.</li> </ul> <hr/> <p><b>Additional advice:</b></p> <ul style="list-style-type: none"> <li>□ Use the machine in an environment with comfortable lighting. It is harmful to your eyes to watch in a too bright or too dark environment.</li> <li>□ Relax your eyes watching for a period of time.</li> </ul>

	<ul style="list-style-type: none"> <li>□ <i>Keep sufficient distance from the machine to protect your eyes and prevent eyestrain.</i></li> <li>□ <i>Adjust the volume to an appropriate level, especially at night.</i></li> <li>□ <i>Use amplifier equipment as the audio input source with caution. If you must use amplifier equipment, the input power should not exceed the maximum speaker power. Otherwise, the speaker can become overpowered and damaged.</i></li> </ul>
	<p><b><i>special remarks :</i></b></p> <ul style="list-style-type: none"> <li>□ <i>The machine can only achieve zero energy consumption when no external input power supply is connected. Therefore, it is recommended to shut down the state when not using to reduce energy consumption.</i></li> <li>□ <i>On the premise of ensuring the viewing quality, energy consumption can be reduced by reducing the brightness of the display.</i></li> <li>□ <i>This machine can be used with all kinds of built-in computers, which can be upgraded or replaced according to your needs.</i></li> </ul>

# 1 Product Overview

---

## 1.1 Product Introduction

This machine is a multi-functional device that integrates interactive conference, digital presentation, multimedia presentation, touch operation, and handwriting input. From design to production, we have fully considered the application characteristics of business conferences to ensure easy and intuitive operation. Through full digital intelligent control, it allows writing, editing, and deleting on the screen using fingers, stylus. It is an ideal machine for modern conferences.

### Features:

- Tailored to the meeting system.
- Adopt advanced capacitive touch sensing technology, HID without drive mode.
- Powerful screen editing function, a variety of line width, color selection, support live editing.
- Wireless screen transmission.
- Support multi-touch, roaming, analog mouse, keyboard operation.
- High brightness, high contrast screen display effect.

## 1.2 Appearance Introduction

---



*There are electronic components in the plastic parts at the bottom of the panel. If the plastic parts are damaged, it may lead to abnormal use of the camera or the product. To avoid damage to plastic parts, please pay attention to the following :*

- Do not hit the bottom plastic part of the plate.
  - Do not place heavy objects on the bottom plastic part of the plate
  - Do not place the bottom plastic part on the ground.
  - Please avoid bumping the bottom plastic part of the plate.
- 

### Front View

TT-6519PTC/ TT-7519PTC / TT-8619PTC

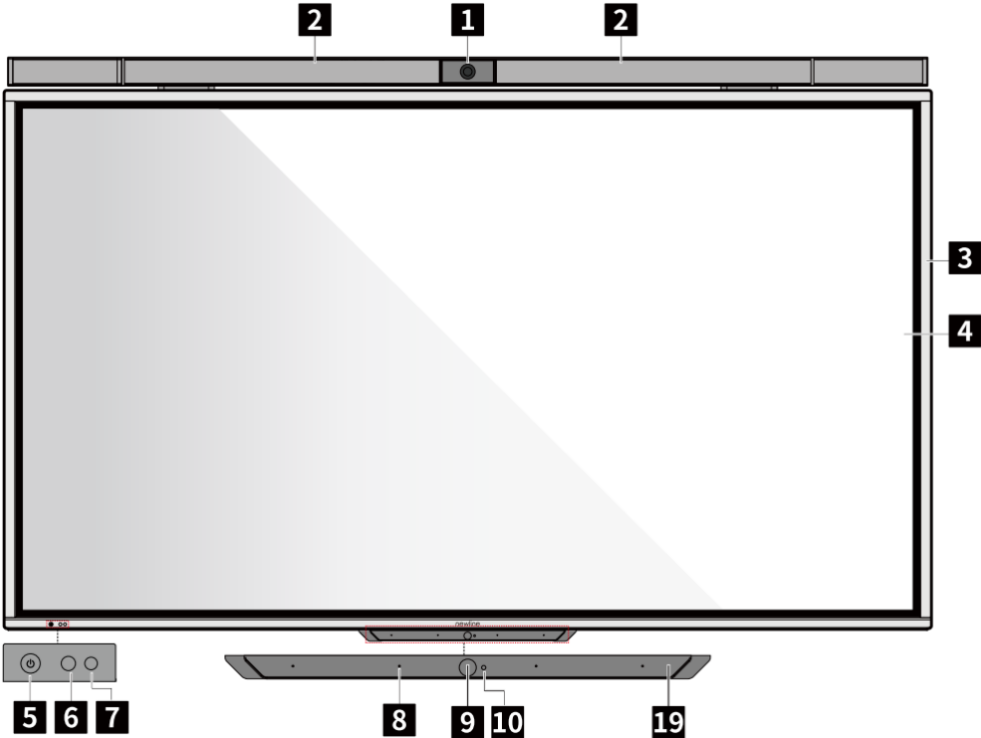

Rear View

TT-6519PTC/ TT-7519PTC / TT-8619PTC

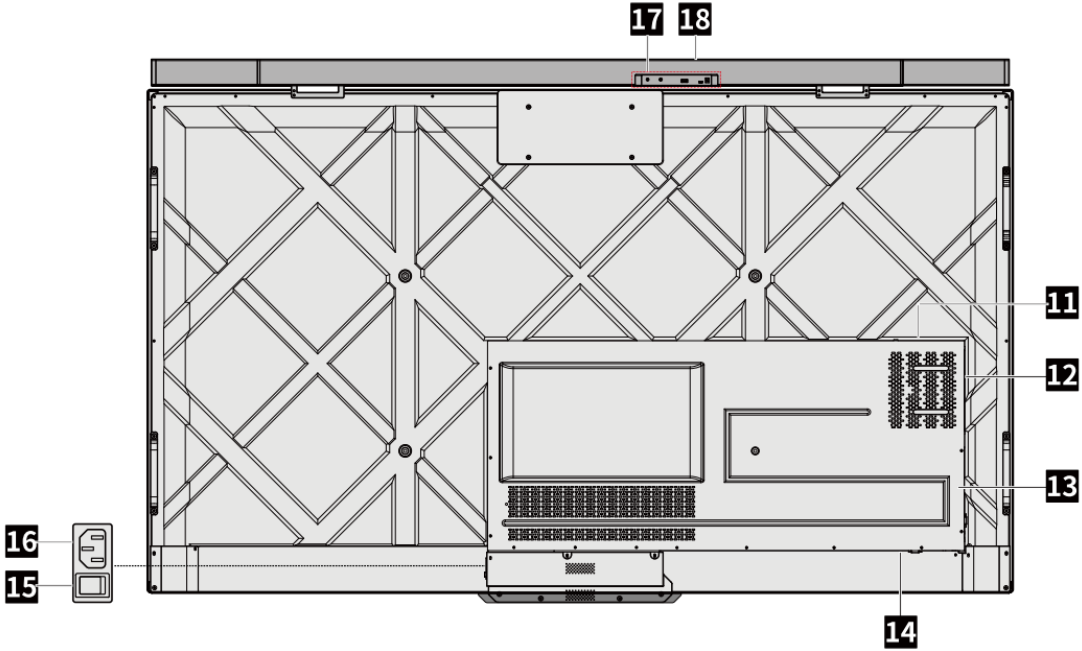

1	Soundbar Camera	11	Soundbar Port
2	Soundbar Speaker	12	Built-in computer ports (ops)
3	Touch Border	13	Rear connecting port 1
4	Screen	14	Rear connecting port 2
5	Power Button	15	Power switch
6	IR Receiver	16	Power socket
7	Light Sensor	17	Soundbar Rear Port
8	Wi-Fi Aerial	18	Soundbar Top Button
9	Camera	19	Bottom plastic parts (Fragile)
10	Mic		

**NOTE**

Soundbar camera Angle can be adjusted downward by manually pressing the bottom of the frame below the camera, up to 20° downward

### 1.3 Front Control Panel

□ **Front Button**



Button	Function
	<p>on/off:</p> <ul style="list-style-type: none"><li>□ If the power is on, press it to enter sleep mode. Press and hold for 2 seconds to shut down.</li><li>□ If the power is off, press it to turn on the power.</li></ul>

# 1.4 Rear Port

TT-6519PTC/ TT-7519PTC / TT-8619PTC

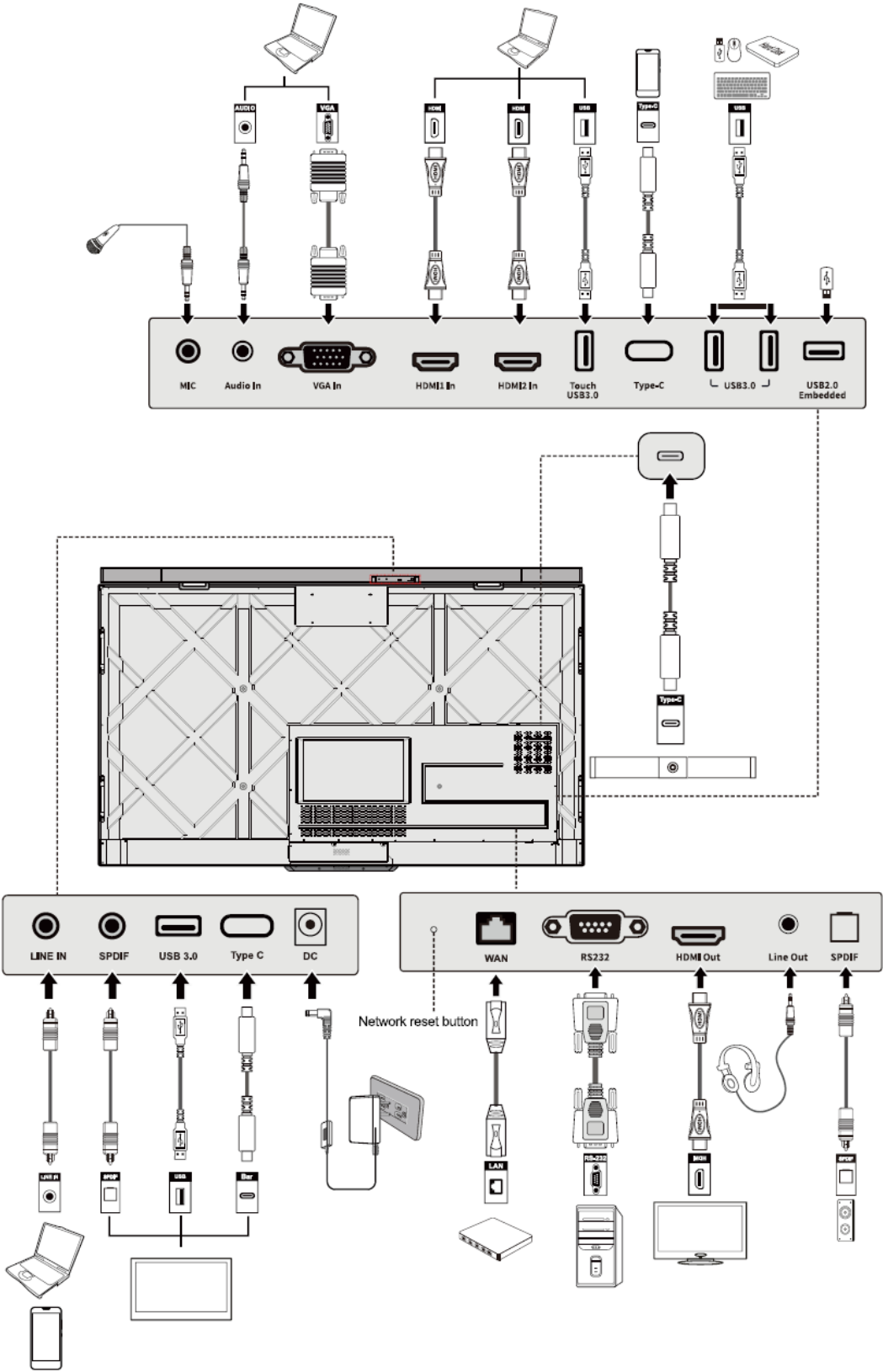

**Rear Ports Introduction:**

Name	Function
MIC	Microphone input port
Audio In	Audio input port, used in combination with “VGA In”
VGA In	VGA signal input port. Used in combination with “Touch USB 3.0” to operate the PC in touch mode.
HDMI 1 In	HD signal input port 1. Used in combination with “Touch USB 3.0” to operate the PC in touch mode.
HDMI 2 In	HD signal input port 2. Used in combination with “Touch USB 3.0” to operate the PC in touch mode.
Touch USB 3.0	Connect to operate the PC in touch mode
Type-C	Connect devices with Type C interface, such as OTG USB flash drive, MAC, PC, mobile phone, etc. Output 5V 3A power supply. It also supports data, audio, video, and charging. The transmission rate is 5Gbps. The maximum resolution for video transmission 3840 x 2160@60Hz.
USB 3.0	Connect the USB device. Such as mobile hard disk, USB flash drive, USB keyboard, mouse. When the display screen is on android, the device on USB is used by android. When switching to the OPS channel, the USB device is connected to OPS.
USB 2.0 Embedded	System upgrade.
WAN	Network port, connect to RJ45 terminal.
Network reset button	Press the reset button for 5 seconds with a pinhole object to reset the network settings of the machine to default.
RS232	Serial port signal input port, which allows inputting serial port settings through a specific serial port control device to control the machine.
HDMI Out	Connect to an electronic video device with HDMI In.
Line Out	Connect to an audio output devices such as headphones and speakers.
SPDIF	Digital audio port. Connected audio equipment with fiber optic input; Such as power amplifier, stereo, speakers.
Soundbar Port	Soundbar Port Warning: This is a special port for Soundbar. Access to other devices is prohibited, otherwise, the device or port may be damaged.



**Soundbar Rear Ports Introduction:**

Ports	Function
Type -c	Contact the port of the machine.
USB3.0	The port for output video source.
SPDIF	Digital audio input interface.
LINE IN	Audio input interface.
DC	Power port.

**NOTE**

When using Soundbar's with the UCD, connect Soundbar to the Type C interface and soundbar port of the panel. The rest of the interfaces are used when Soundbar is not used with the UCD.

**1.5 Soundbar Top Button :**



Icons	Function
	Switch the audio input source.
	Turn on or off mute.
	Decrease in volume.
	Increase in volume.

**NOTE**

If no sound coming out from the soundbar, the soundbar might switch to another audio input source or mute by pressing the button unintentionally, please try to press the button or button.

**⚠ WARNING**

- *Front USB 2.0 ports and rear USB 3.0/USB 2.0 ports switch connections based on signal sources. If the current signal source is reading the data from external storage connecting to the port, please don't switch the signal source until the data reading is complete. Otherwise, the data or product may be damaged.*
- *USB2.0/USB3.0 ports output: 5V/500mA (Max.). For qualified device use only otherwise may cause electrical shock or fire.*
- *Soundbar Connecting port output: 18V/3A. Soundbar connecting port may only use for Soundbar. The manufacture cannot be responsible for the possible damage caused by connecting to other devices.*















## 1.6 Remote Control

**⚠ CAUTION**

*To avoid probable faults, please read the following instructions and use the remote controller properly:*

- *Do not drop or beat the remote controller.*
- *Do not spill water or other liquid on the remote controller.*
- *Do not put the remote controller on wet items.*
- *Do not expose the remote controller under sunlight or put it near an overheated source.*



Buttons	Functions
	Turn on/off.
<b>Standby</b>	Enter/exit the screen off mode.
	Mute or unmute.
	Microphone switch.
	Up/Down/Left/Right selection button.
<b>OK</b>	Confirmation button.
	Press once to return to the previous page; Press twice to exit the current program.  Note: In the settings page, press once to exit.
	Return to the homepage.
	Open the task management sidebar.
	Decrease the volume.
	Increase the volume.
	Opens the bottom toolbar (no function on the homepage and the app list page).
	Open the app list page.
	Turn the brightness bar on/off (drag the slider to adjust the brightness).
	Enter the Settings page.
<b>HDMI</b>	Reserved.
<b>TYPE-C</b>	Switch to Type C source
	Lock/unlock screen touch function.
<b>HDMI1</b>	Switch to HDMI1 source.
<b>HDMI2</b>	Switch to HDMI2 source.
<b>Screen Capture</b>	Enable screenshot function.
<b>VGA</b>	Switch to VGA source.
<b>PC</b>	Switch to the built-in computer source.

### 1.6.1 Range of Remote Control

Use the remote control within the range of about 5 meters in front of the remote control receiver of this machine and about 30 degrees on both sides.

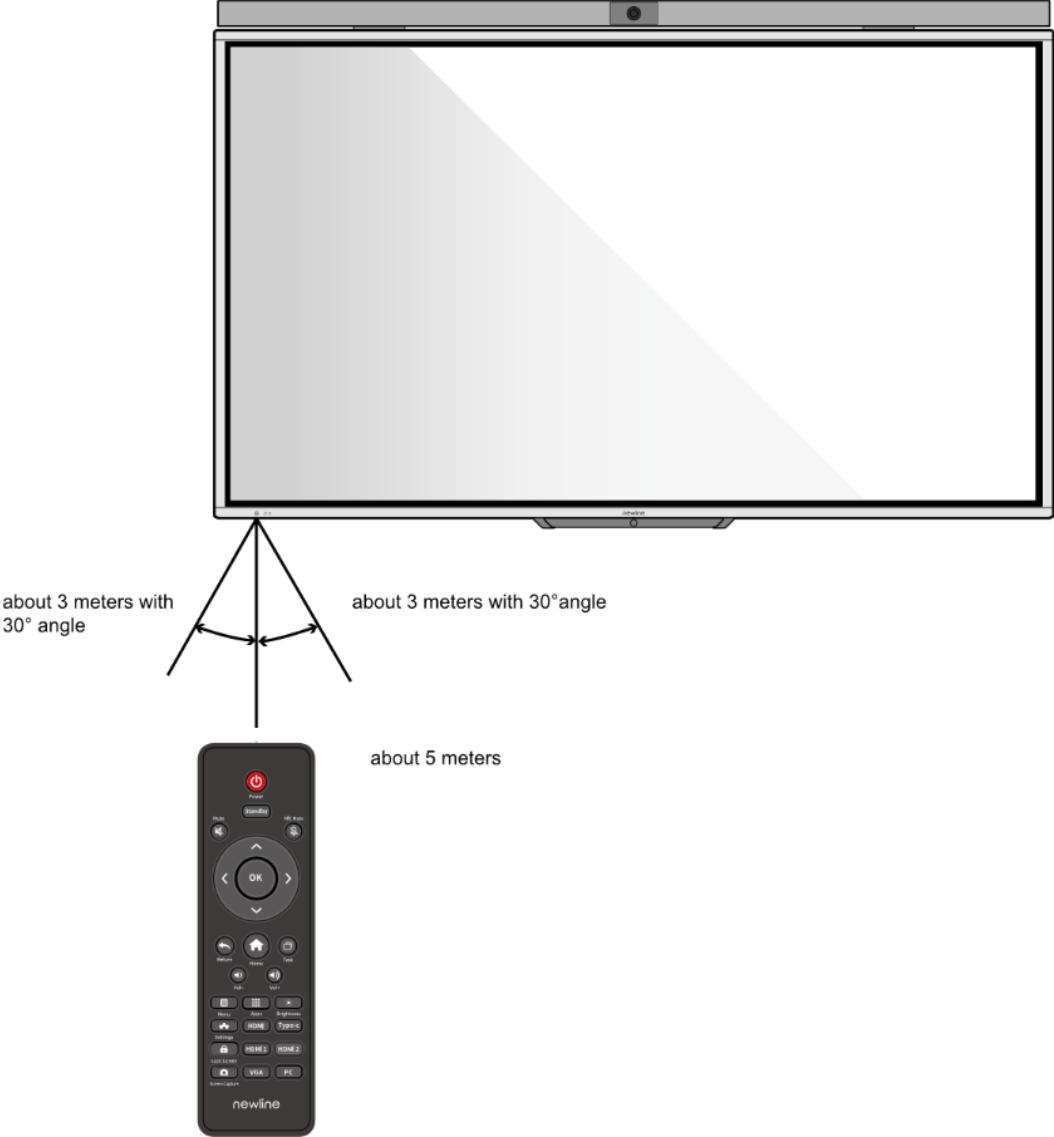

# 2 Installation Guide

## 2.1 Safety Precautions

### Installation Environment



### Installation Direction

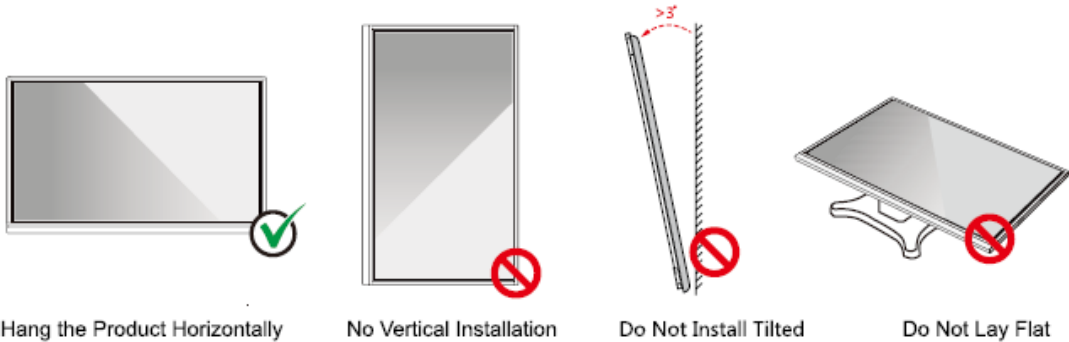

## 2.2 Weight Loading

Net weight of the machine(65",75",86"): 40kg(±2kg), 50kg(±2kg), 61kg(±2kg).

- When using a mobile stand, ensure that the weight of the machine is less than the loading capacity of the mobile stand.
- When using the wall-mount bracket, ensure that the wall can support the weight of the machine. We recommend that the wall surface be reinforced and have a loading capacity 4 times the weight of the machine. Consult a professional installer for wall-mount installation.

### NOTE

- *The company does not undertake relevant legal responsibility for any problems caused by the improper operation if the third-party mobile stand, or wall-mount bracket is beyond the scope of the machine.*
- *Do not install the machine where it might be hit by an opening or closing door.*

### □ Vertical Installation

When installing, try to keep the machine vertical. The vertical tilt range allowed for wall-mount installation is  $\pm 3$  degrees. An excessive tilt angle may cause the screen glass to fall off or the machine to collapse.

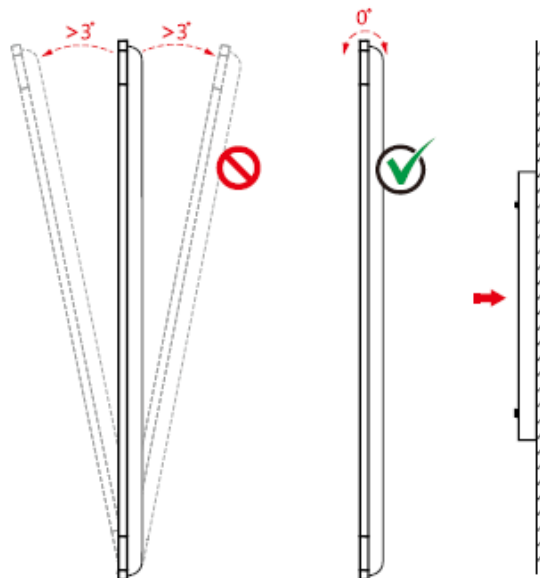

### NOTE

- *In case of broken glass, all personnel must stand 3 meters away from the machine to ensure safety.*
- *Do not install or disassemble the machine if the glass is broken.*
- *For any problem, please contact our support desk. Our company is not responsible for any damage or losses incurred by users if the users fail to follow the instructions.*

## 2.3 Ventilation

Distance from mounting surface (mm)			
Left and right sides	Top	Bottom	Rear
100	200	200	100



**CAUTION**

- *In addition to the above requirements, the area of the bottom, side, and top vents should not be less than 50% of the sealing area and good air circulation must be maintained when the machine is embedded in the wall and a cabinet.*
- *For wall mounting, the depth of wall bolts should be greater than 10mm.*

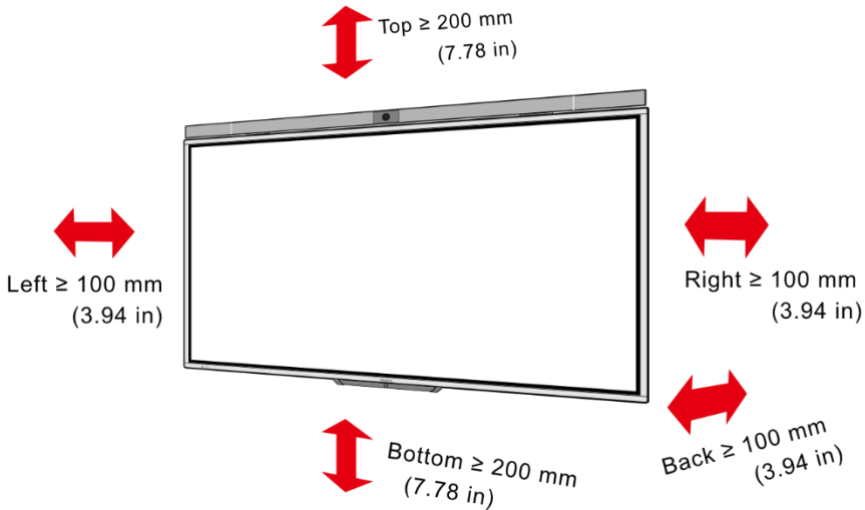

\* Refer to the CAS 132-2006 standard.

## 2.4 Installing the Built-in Computer



### CAUTION

The built-in computer does not support hot-plugging. Therefore, you must insert or remove the built-in computer when the display is powered off. Otherwise, the display or built-in computer may be damaged.

Perform the following steps to install the built-in computer:

Step1 Unscrew the screws by hand to remove the built-in computer shielding cover.



### NOTE

This step is optional and applies to models with shielding cover.

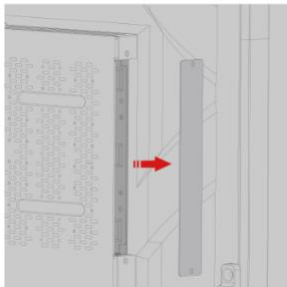

Step2 Push the built-in computer into the port at the rear of the machine from right to left.

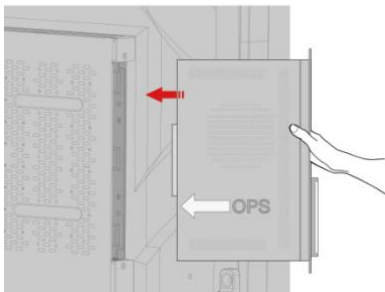

Step3 Secure the built-in computer to the machine by using the screws.

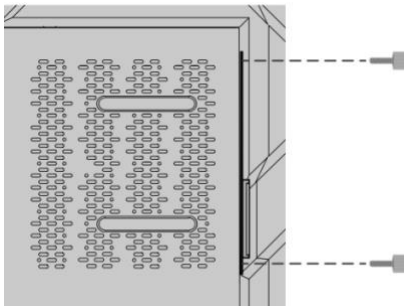

### NOTE

If the screen fuzzes, flashes, or if no signal is received from the built-in computer channel after turning on the power, it means that the built-in computer has not been properly installed. Please check it and re-install.



## 2.5 Installing the Soundbar

Perform the following steps to install the Soundbar:

- Step 1 Loosen the hex screws on the back panel, place the Soundbar bracket in the designated position and fix it on the plate with hex screws

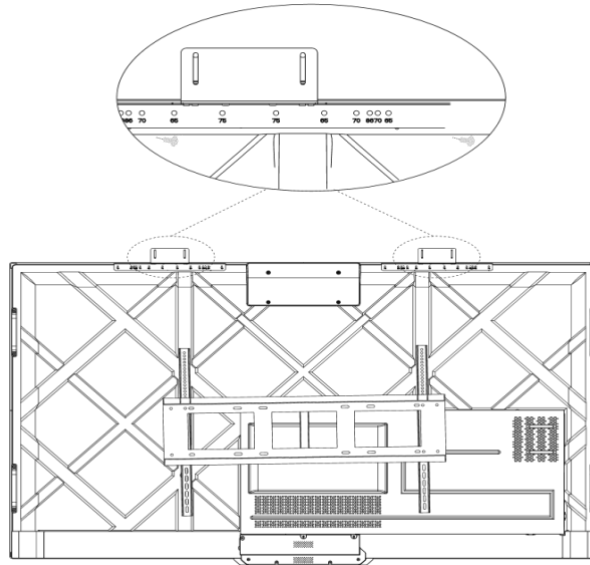

- Step 2 Place the Soundbar on the bracket, adjust the left and right sides in parallel, and fix it on the bracket with hex screws.

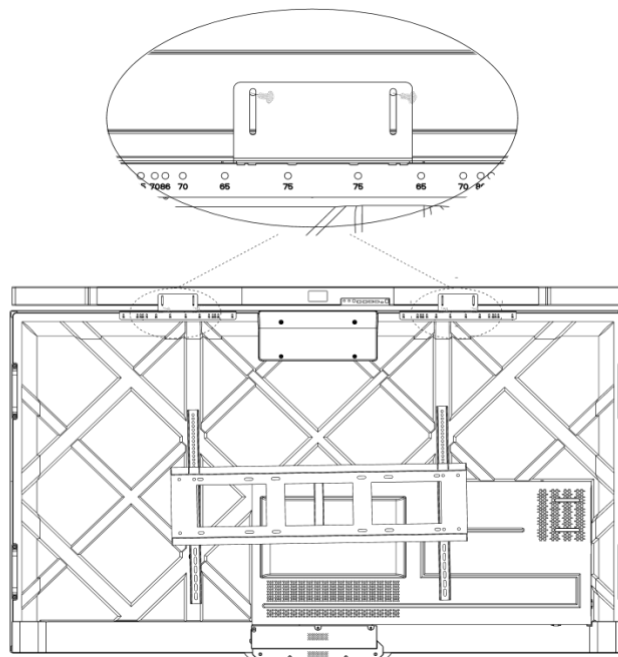

Step 3 Connect the soundbar with the Type C port (Soundbar) and Soundbar Connection port (UCD).

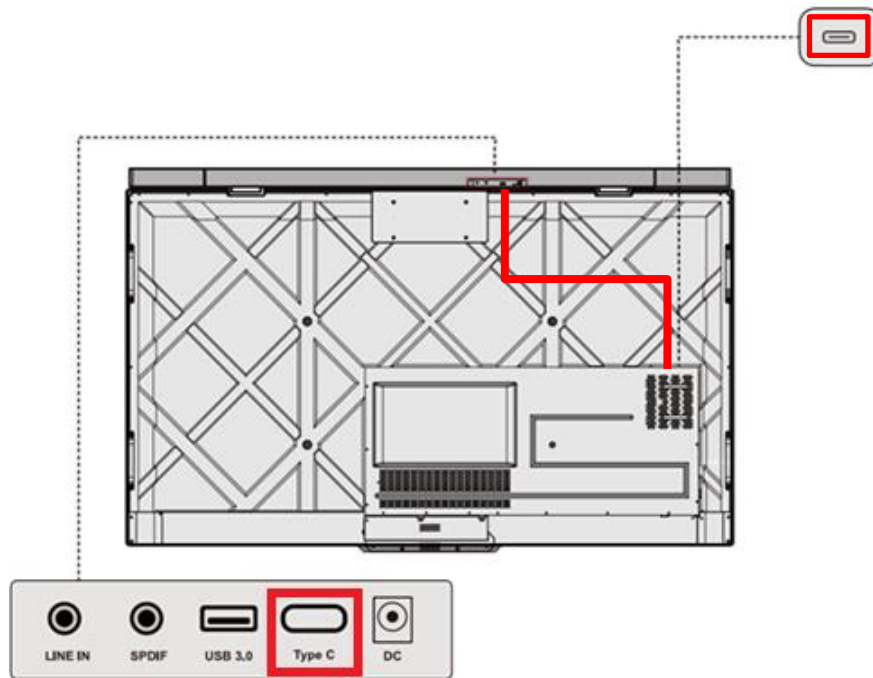

# 3 Turning On /Off

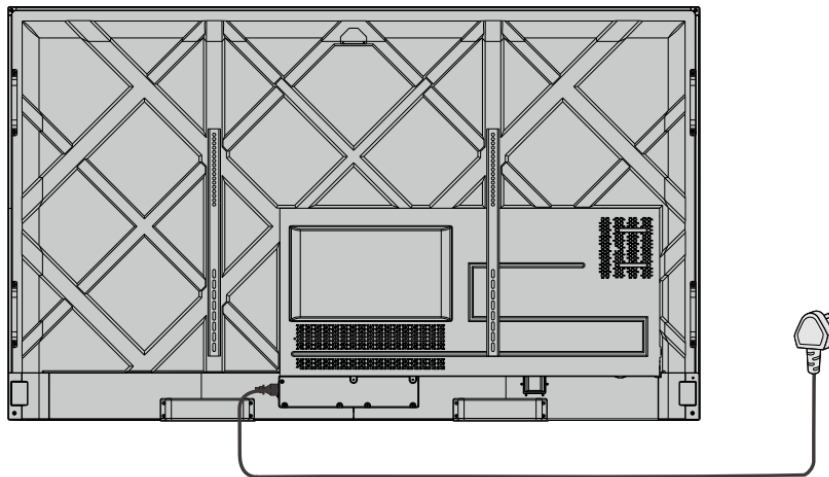

## 3.1 Power On

Step 1 Use AC power (100V~240V, 50Hz/60Hz) as the machine power source. Make sure the power plug is fully inserted and that the ground wire of the outlet is properly connected.



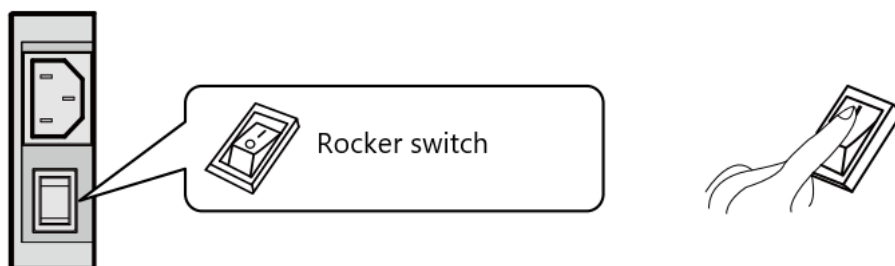

Step 2 Turn on the rocker switch (on the rear side of the machine, next to the power socket), after a power source has been connected. The power indicator should be red.



Step 3 Press the “” button on the front panel or the “” button on the remote control to start the machine (the indicator light turns green).

### 3.2 Power Off

- Step 1 Press the “” button on the remote control or long-press the “” button on the front panel to turn the machine power off. The indicator light turns red.
- Step 2 If you want to completely turn off the machine, turn off the rocker switch on the rear of the machine (next to the power socket) and unplug the power cord.

 **CAUTION**

- *When the machine enters sleep mode or is turned off, the system will first detect whether the built-in computer is turned off. If not, it will turn off the computer first and then enters sleep mode or shutdown.*
- *Please shut down the machine before disconnecting the power source, or it may damage the machine. An accidental power failure may damage the machine.*
- *Do not repeatedly turn the power on & off in a short period of time as it may cause malfunction.*

### 3.3 Indicator Status

Indicator	Machine Status
Off	Shut down or power disconnected
Red	Shutdown
Green	Screen off/normal working state
Green flashes (every 2 seconds)	Sleep mode
Green on, red flashes once every 3 seconds	Locked screen

 **NOTE**

- *When the machine is turned on, short press the power button on the front panel to enter sleep mode; short press the power button on the front panel again, or press any button on the remote control or tap the screen twice to wake up the screen.*
- *When the machine is turned on, press the “**Lock Screen**” button on the remote control to lock screen; press the “**Lock Screen**” button on the remote control again, or short press the power button on the front panel, or tap the screen three times in quick succession to resume the touch control.*
- *When the machine is turned on, hold the screen for more than 3 seconds with 3 fingers to turn the screen off; short press the power button on the front panel, or press any button on the remote control or tap the screen to turn the screen on.*

# 4 Basic Operation

## 4.1 Home

The machine will automatically enter the home page after starting up. In any interface, press the "Home" button on the remote control or floating bar to enter the home page. The home page is shown below:

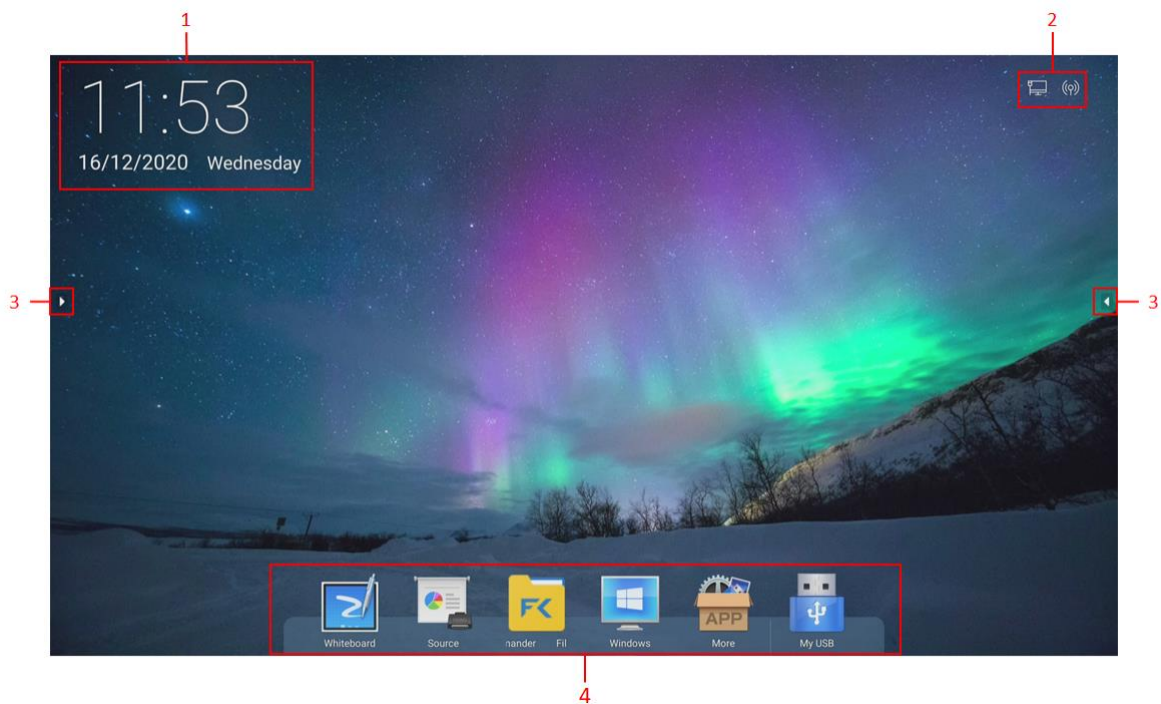



No.	Name	Function
1	Time & Date	Tap to enter the date/time settings page
2	Status Bar	Show network status information, including wired network, Wi-Fi, and hotspot status. Tap the status icon to enter the settings page
3	Floating Bar	Expand/hide the side tool icons
4	Bottom Toolbar	Tap the icon to enter the corresponding app interface. The default app icons include Whiteboard, Source, File Commander, Windows (If OPS PC plugged in), More, and MyUSB (If USB flash drive plugged in)

 **NOTE**

- The bottom toolbar can be customized (default icons can't be modified). Details please refer to **section 4.4.2**.
- If any external storage device is connected, the storage device icon will appear in the bottom toolbar. When the built-in computer is properly installed, the **"Windows"** icon will appear in the bottom toolbar.
- Most of the functions of the machine require a network connection. Please connect the network correctly and ensure that it is unimpeded.





## 4.2 Status Bar

Status icons (including wired network, Wi-Fi, and hotspot status) are displayed in the top right corner of the homepage.

Icon	Function
	This icon is displayed on the homepage when the machine is connected to Wi-Fi.
	This icon is displayed on the homepage when the machine is connected to the network via a network cable.
	This icon is displayed on the homepage when the hotspot of the machine is turned on.

## 4.3 Floating Bar

On the homepage, tap the  icon to expand all icons within the floating bar.

Icon	Function
	Expand/hide the floating bar
	Return to the Android homepage (not shown in homepage)
	Return to the previous menu (not shown in homepage)
	Enter annotation mode (not shown in whiteboard interface)
	Bring up the task management sidebar

### 4.3.1 Task Management Sidebar

Tap the “☰” icon in the floating bar to enter the task management sidebar, which consists of the task management bar, toolbar, and notification bar. As shown below:

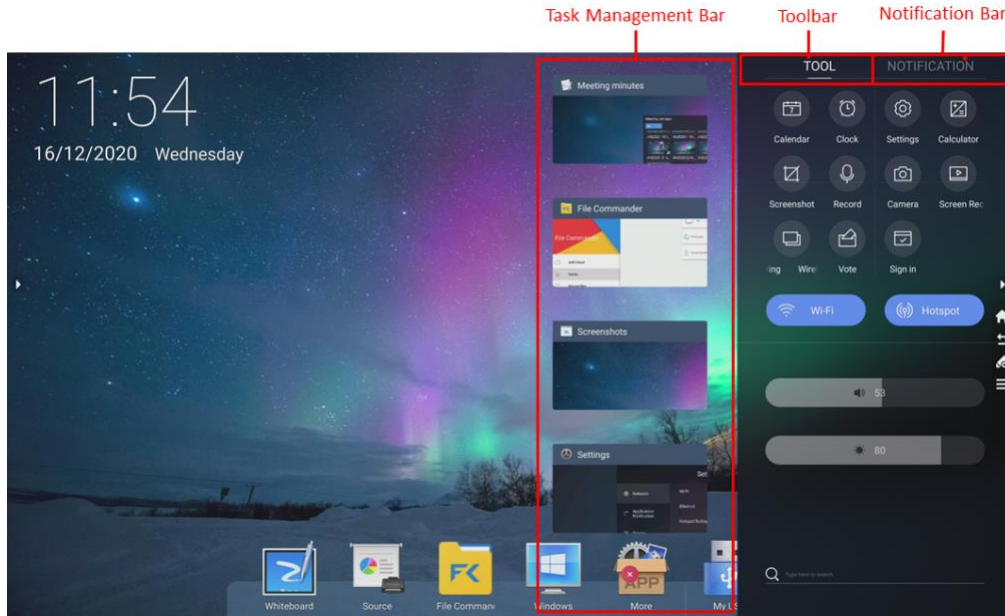

#### Task Management Bar

The user can perform the following operations using the task management bar:

1. **Open an app:** Tap the task management widget to enter the app interface:
2. **Close an app:** Swipe left and right to close the corresponding app,
3. **Close all apps:** Tap the “✖” button at the bottom to close all apps.

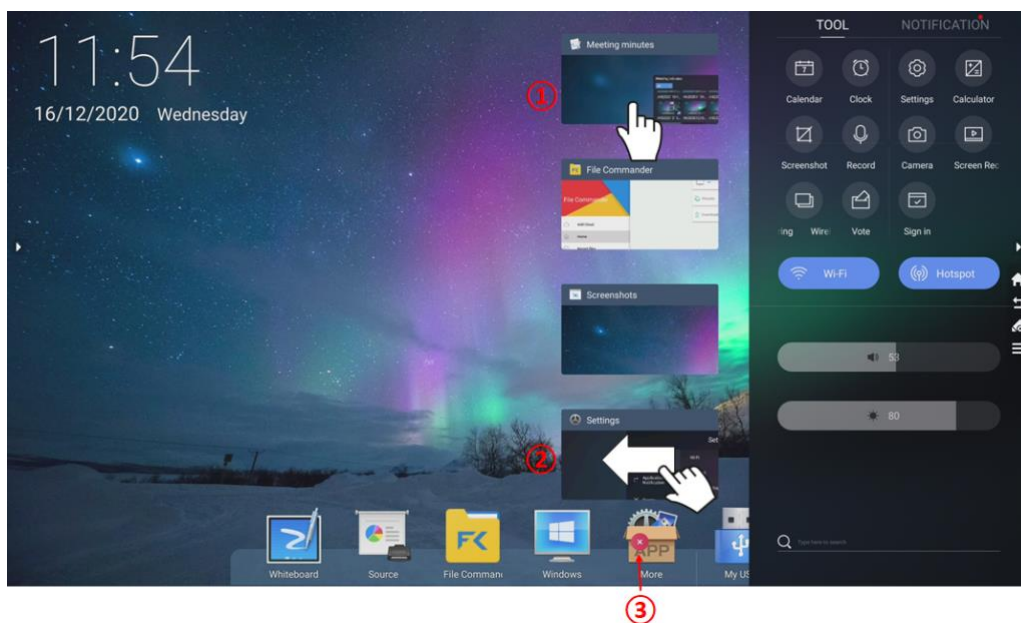

## Tool

The user can perform the following operations on the toolbar:

### 1. Tool / Notification switch:

- You can view the notification content in the notification, swipe left to delete a notification, and tap the × icon in the upper right corner to clear all notifications.

### 2. Tool:

- Quick access to Calendar, Clock, Setting, Calculator, Screenshot, Record, Camera, Screen Recording and Wireless Screen Sharing, vote and sign in. For more details of the apps, please refer to **section 5.3**

#### NOTE

- *“Screenshot”, “Record”, “Screen Recording” are only available in “Tool”.*
- *“Screenshot” application can also be activated by “Screen Capture” on the remote control.*

### 3. Wi-Fi / Hotspot Switch On/Off:

- Tap the **“Wi-Fi”** button to turn on/off the Wi-Fi; hold to enter the settings page;
- Tap the **“Hotspot”** button to turn on/off the hotspot; tap and hold to enter the settings page.

4. **Adjust Volume / Brightness:** Slide your finger on the bar to adjust volume and brightness

5. **Search Shortcut:** Enter content into the search box and tap the search icon to enter the search page

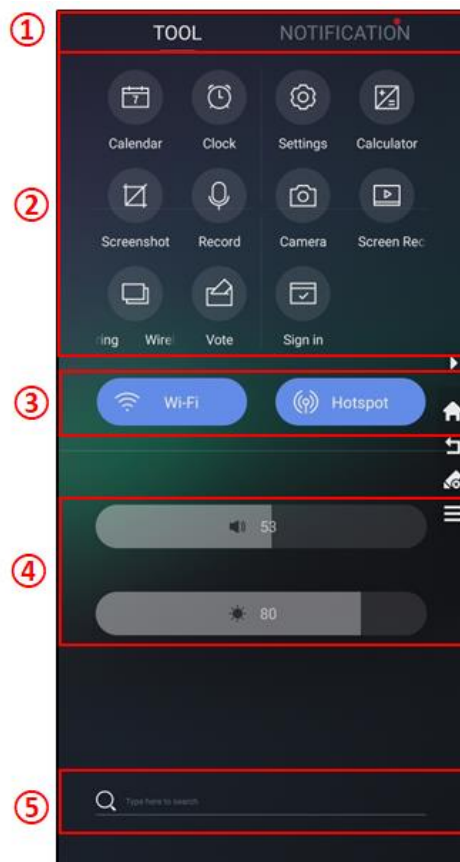



## Notification

The user can view the notification content in the notification bar, swipe left to delete a notification, and tap the

“” icon in the upper right corner to clear all notifications.

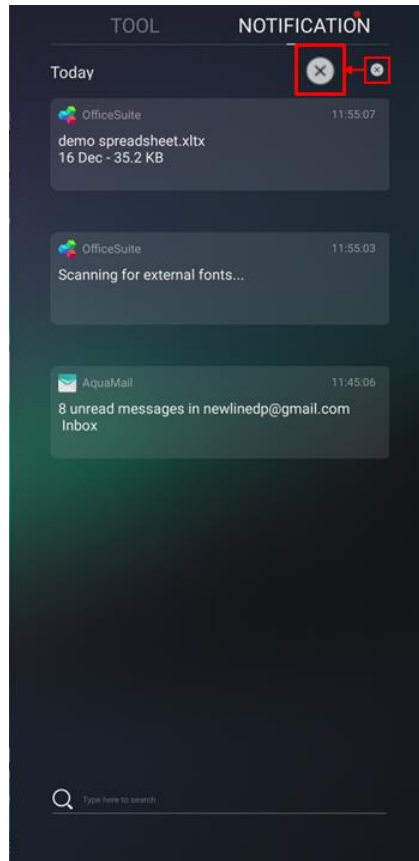

## 4.4 Bottom Toolbar

Tap the icon to enter the corresponding app interface. The default app icons include Whiteboard, Source, File Commander, and More.

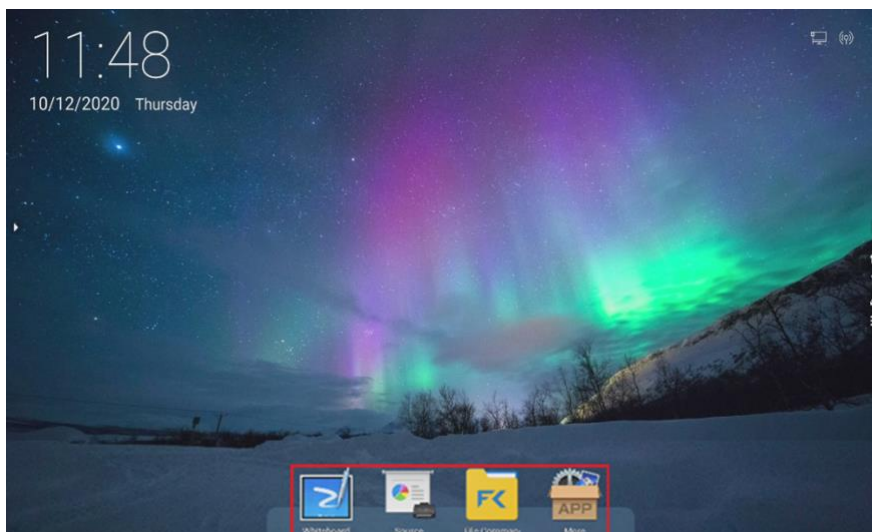

## 4.4.1 View and Hide Bottom Toolbar

Two fingers swipe vertically upward from the black border below the display area to call out the bottom toolbar, as shown below:

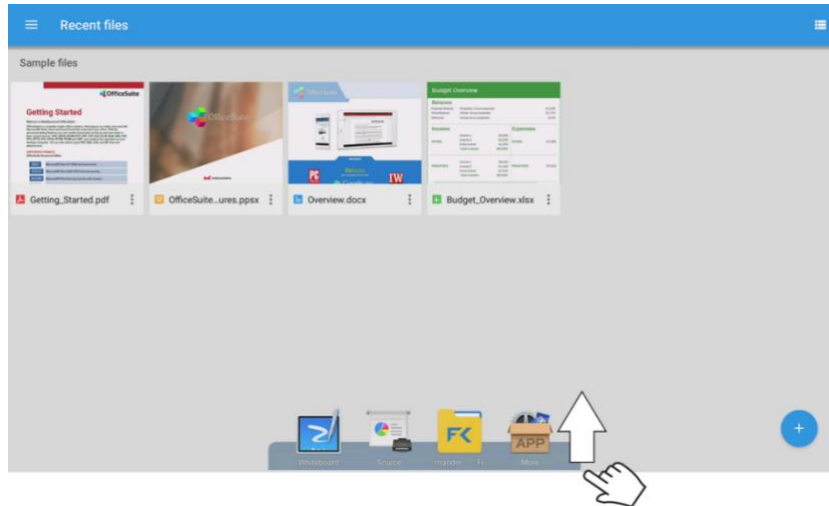

### NOTE

- To call out through gesture, make sure that the bottom toolbar is shown. This setting can be customized under “Settings > Display > Close the bottom toolbar”.
- Except the homepage and the “More” interface (the bottom toolbar is not hidden), the user can call out the bottom toolbar through this operation in any other interface.

## 4.4.2 Edit Bottom Toolbar

In the “More” interface, the user can add or delete an icon in the bottom toolbar by holding any app icon until all icons begin to jiggle.

- Add an app icon: Drag the icon to the bottom toolbar and tap the “Completed” button in the interface, as shown below:

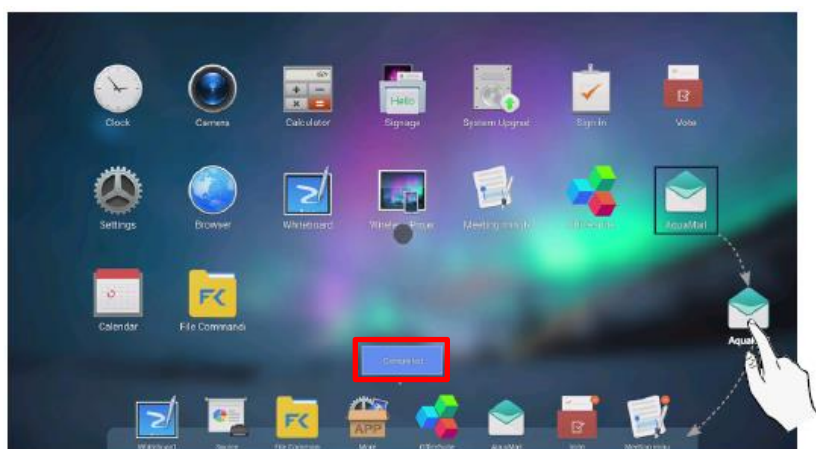

- Delete the app icon: Tap “” in the upper right corner of the icon, and then tap the “Completed” in the interface to delete the app icon the user has added, as shown below:



 **NOTE**



*The default applications in the bottom toolbar (Whiteboard, Source, File Commander, More, Windows (if OPS Plugged in), and My USB (if USB Flash drive plugged in)) are not editable.*

## 4.5 More – App List Interface

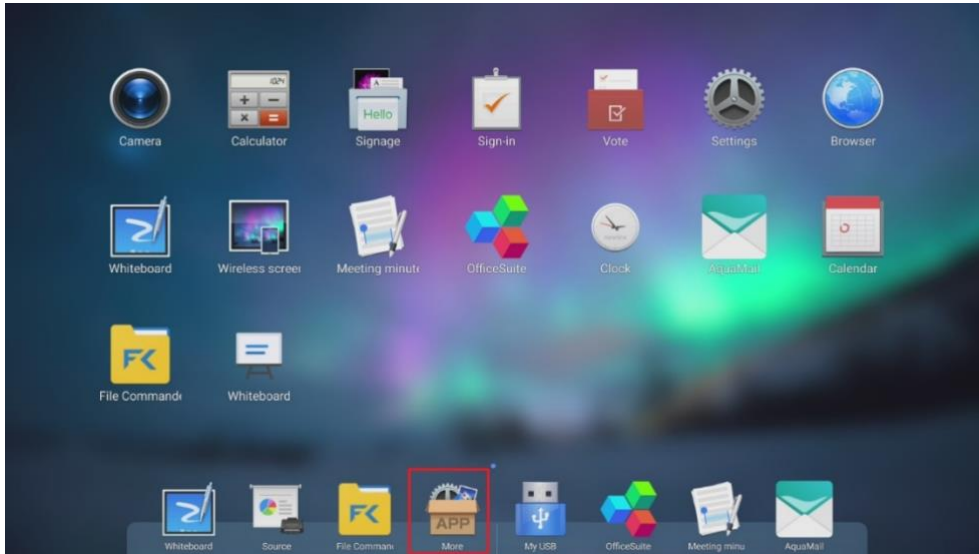
Tap the “” icon on the bottom toolbar to enter the app list interface, as shown below:



Hold any app icon until the icons begin to jiggle to enter the app editing mode. While under the app editing mode, the user can perform the following operations:

- Add an app shortcut to the toolbar: Drag and drop the app icon to the bottom toolbar to add an app;
- Remove an app: Tap the “” button in the upper right corner of the app icon to remove the app from the bottom tool
- Uninstall an app: Tap the “” button in the upper right corner of the app icon to uninstall the app.

 **NOTE**

*The apps that come with the system can't be uninstalled. The user can only uninstall the apps that the user has installed.*

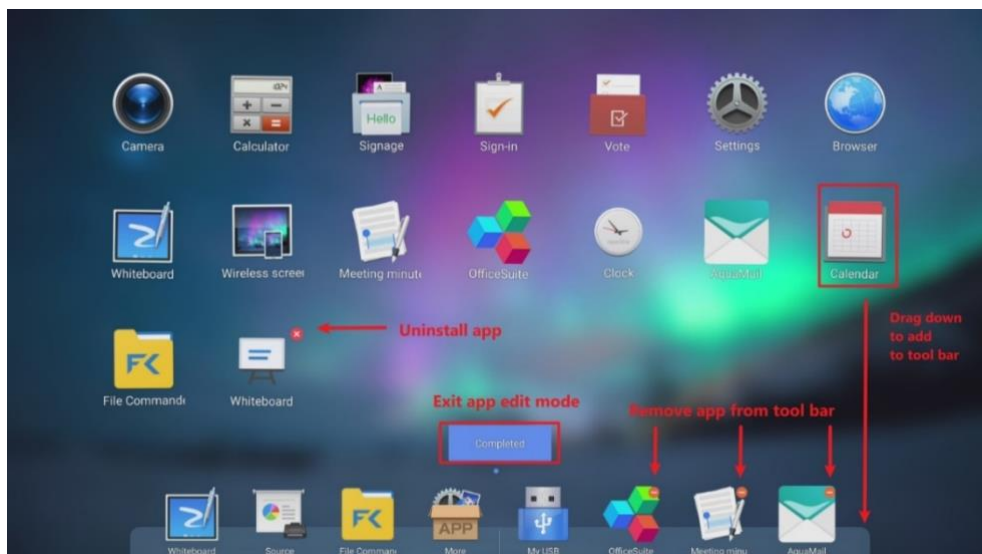

## 4.5.1 Newline Assistant (OPS Pluggable PC Needed)

Users can add Windows software in the OPS pluggable PC as shortcut in the “More” interface

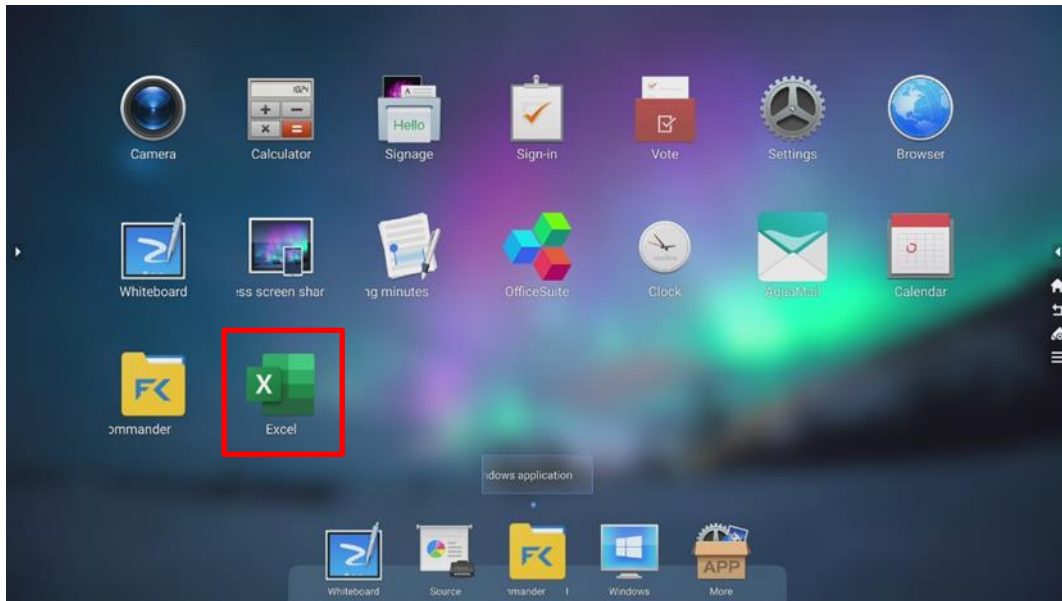

1. Install “Newline Assistant” in OPS Windows.

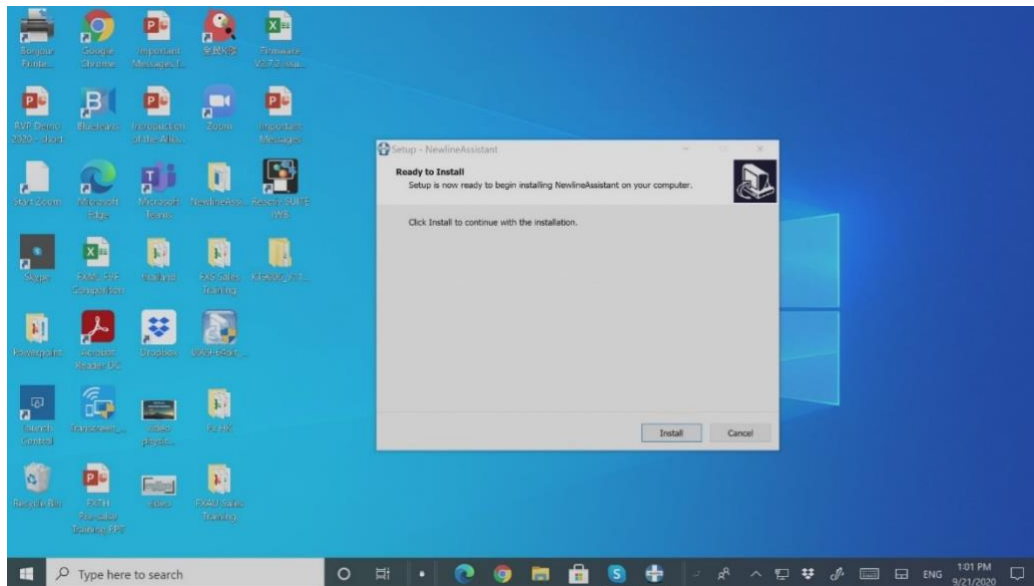

2. Restart the UCD after install

3. Tap **“Add Windows Application”** and you will see all the Windows application in the OPS

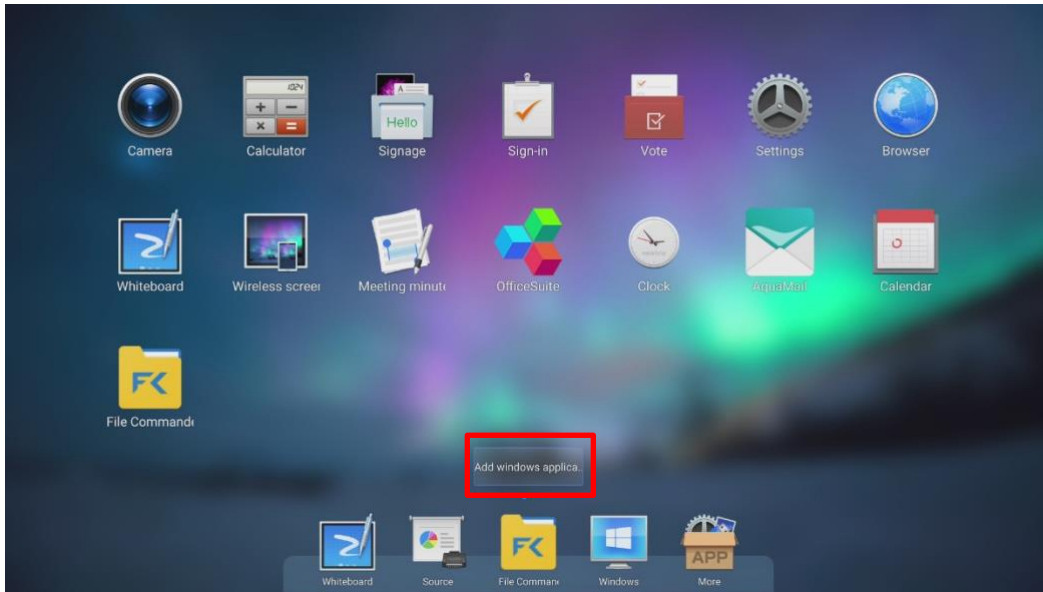

4. Choose the Windows Software you need for shortcut and tap **“Add”**

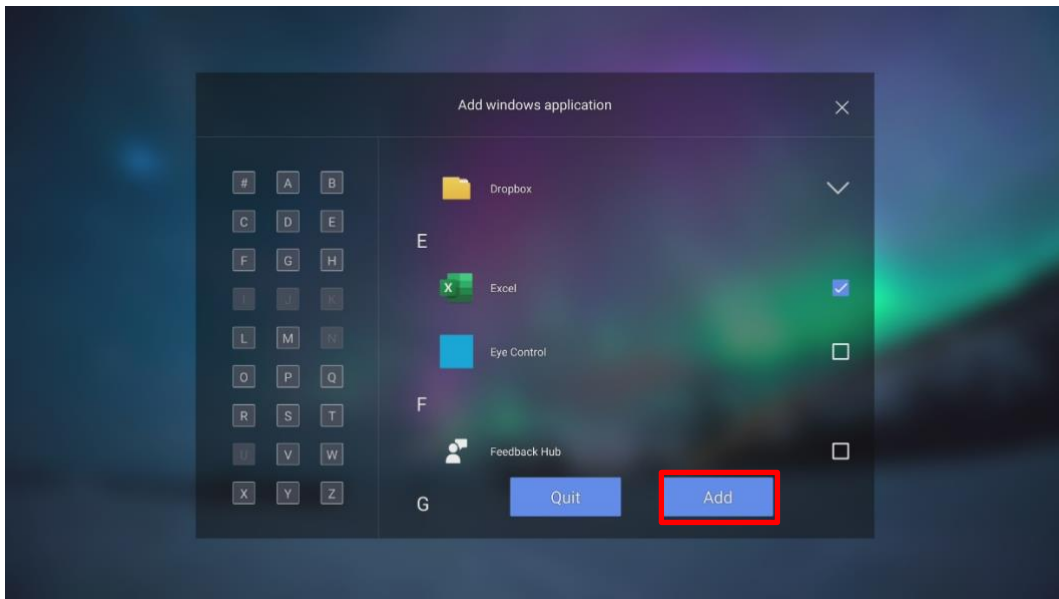

## 4.6 Screen Off

In response to energy conservation and environmental protection policies, we have provided the machine with a screen off function. When only audio is required, the user can turn off the screen. While the audio or video clip is being played, the screen is turned off, and the power indicator is green.

The user can turn off the screen through the following two methods:

- When the machine is turned on, press the “**Standby**” button on the remote control;
- When the machine is turned on, press and hold the screen for more than 3 seconds with 3 fingers;









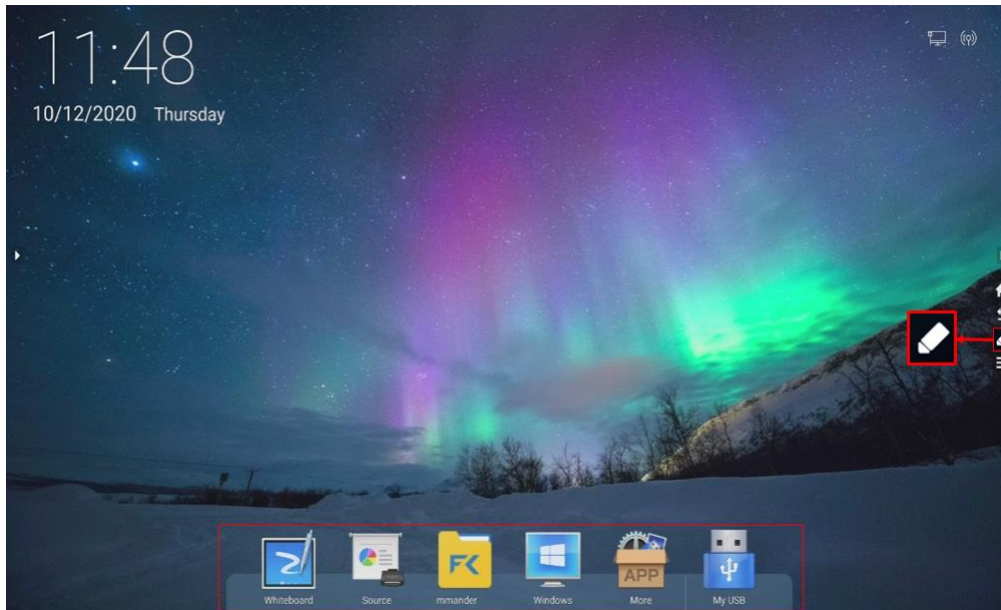

To restore the operating mode before the screen is turned off, the user can exit the screen off mode through the following three methods:

- Short press the power button;
- Press any button on the remote control;
- Tap the screen to restore exit the screen off mode.

# 5 Applications

## 5.1 Floating Bar and Bottom Toolbar - Default Applications



Buttons	Functions
	<b>Screen Annotation:</b> Enter annotation mode
	<b>Whiteboard:</b> Enter Whiteboard application
	<b>Source:</b> Enter projection toolbar including – Wireless Screen Sharing, HDMI 1, HDMI 2, VGA and Type C
	<b>File Commander:</b> Enter File Commander application
	<b>Windows:</b> Enter Windows interface <i>(Only shown if OPS PC plugged in)</i>
	<b>More:</b> Enter apps list interface
	<b>My USB:</b> Enter USB Flash Drive <i>(Only shown if USB flash drive plugged in)</i>



## 5.1.1 Whiteboard & Screen Annotation

### 5.1.1.1 Whiteboard

Tap the “” icon in the bottom toolbar to enter the “**Whiteboard**”

The whiteboard function is designed to present conference writing to attendees quickly and easily. Users can write, draw, and take screenshots on the whiteboard page.

The Whiteboard support 1 – 4 Points For Writing or drawing at the Same Time, and 5 Finger gesture as an eraser.

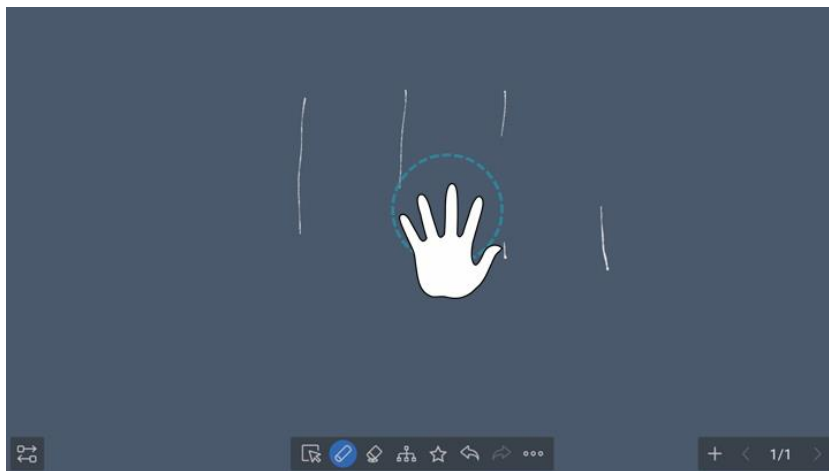
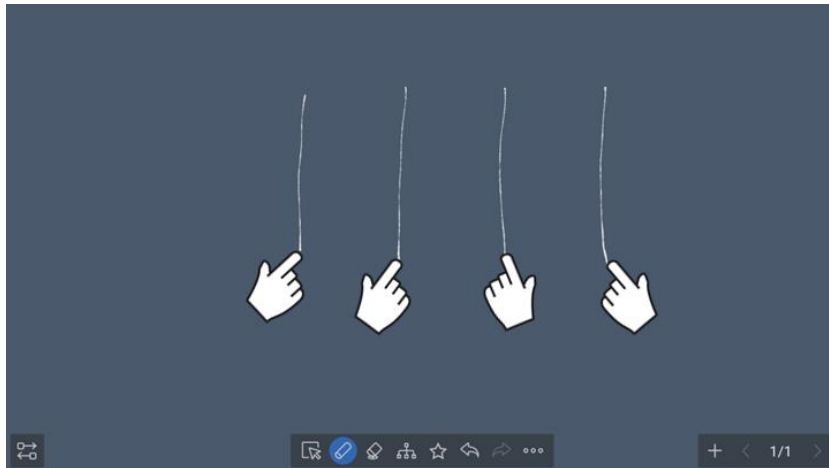

#### **NOTE**

*Writing Tools support Finger or Stylus Pen*

□ Whiteboard toolbar

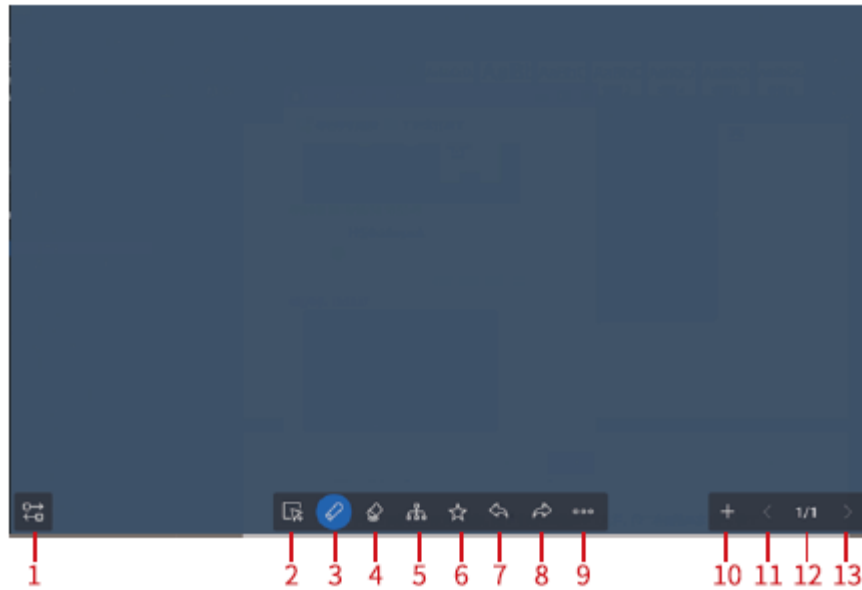

No.	Name	Function
1	Toggle Button	Move “ + < 1/1 > ” to the other side for easier user operation.
2	Select	<p>Tap the icon to select and edit the whiteboard content.</p> <ul style="list-style-type: none"> <li>□ When a written text is selected, the user can save the text as an image which supports zooming, and press ✂ for move ;</li> <li>□ When the tool is selected, the user can move, zoom in/out, or delete images, flowcharts, materials, and small icons inserted in the whiteboard.</li> </ul>
3	Annotate	Tap the icon again to select the writing tool, thickness, and color. Three types of writing tools are available: Chalk, pen and highlighter
4	Eraser	Tap the icon to erase whiteboard content. Supports large area and five-finger erase functions. Tap the icon again to select the eraser size or clear the screen.
5	Flow Chart	Tap the icon to enter the graphic selection interface.

No.	Name	Function
6	Icon	Tap the icon, select the desired icon from the icon menu, and drag it to the whiteboard.
7	Undo	Tap the icon to return to the previous step.
8	Redo	Tap the icon to restore the action that was canceled in the previous step.
9	More	Tap the icon to enter the function selection interface. Functions include: Insert, Search, Background, Annotate, Share, Open, Save, Exit, etc.
10	New	Tap the icon to create a new whiteboard page.
11	Previous	Click to enter the previous page.
12	Browse	Tap the icon to view all whiteboard pages, jump to the page by tapping on the page thumbnail. Select single or multiple pages to delete if required.
13	Next	Click to enter the next page.



 **NOTE**

Whiteboard record will be saved automatically to **Meeting Minutes** after exiting the whiteboard.

 **More Menu**

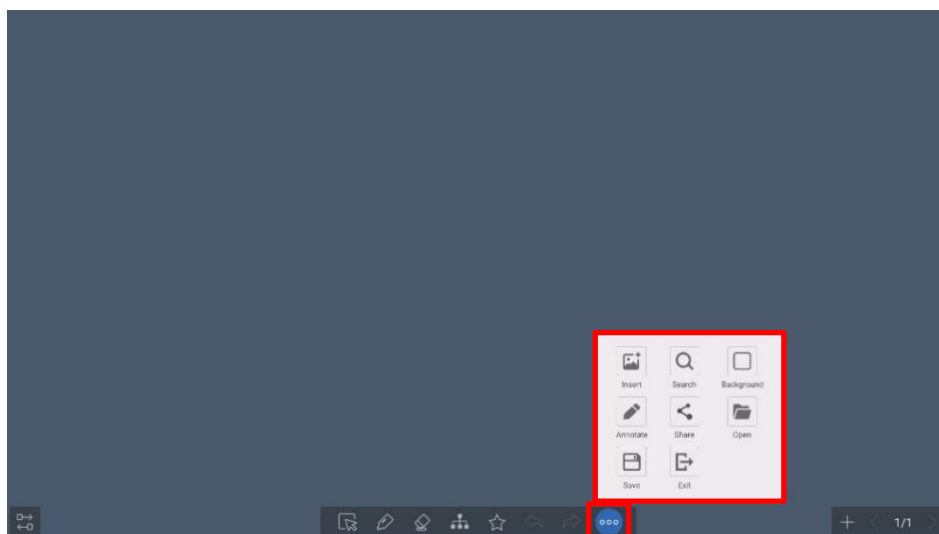
In the whiteboard toolbar interface, tap the “” icon to access more menus as shown below:





- Insert: Insert pictures, videos, and PDF files into the whiteboard, in video and PDF file, tap “” to insert the current page into the whiteboard as an image for edit and annotation.
- Search: Enter Google homepage by default. In the search page, tap “” to insert the current page into the whiteboard as an image for edit and annotation.
- Background: The background is divided into Color and Picture, which can customize picture as the whiteboard background.
- Annotate: Tap to enter the annotation mode.
- Share: Tap to share by application, or generate a QR code, scan the QR code by your mobile device to access shared content. The current page is shared by default. The user can also select and share all other whiteboard pages.
- Open: Open whiteboard source file and third-party software file (supports Excel, PPT, Word, and TXT).
- Save: Save the current whiteboard content to the “**Meeting Minutes**” in PDF or source file format.
- Exit: Exit the whiteboard.

### 5.1.1.2 Screen Annotation

In annotation mode, the system generates a transparent layer at the top of the screen, and users can add annotations on to the transparent layer until the annotation mode is exited.

The user can enter the annotation mode through the following two methods:

- Tap the “” icon on the floating bar;
- On the “**Whiteboard**” interface, enter the “” menu interface and tap the “” icon.

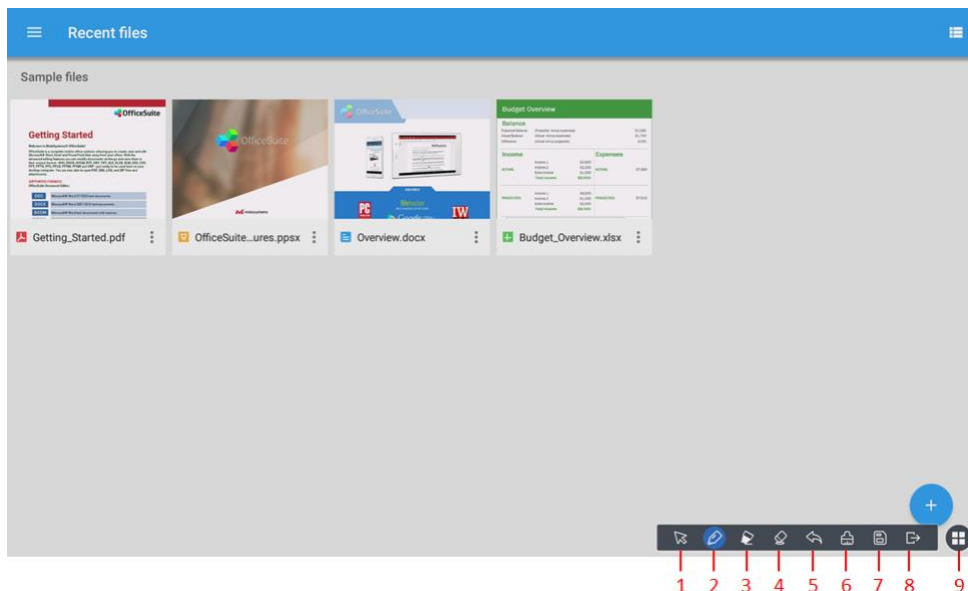

No.	Name	Function
1	Select	Tap this icon to return to the current interface from the annotation mode to control the application or interface.
2	Pen	Tap the icon to enter the writing state. Tap again to set the pen color and thickness.
3	Highlighter	Tap the icon to enter the highlighter writing state. Tap again to set the highlighter color and thickness.
4	Eraser	Tap the icon to enter the eraser function. Tap again to set the eraser size.
5	Cancel	Return to the previous step.
6	Clear Screen	Clear all content on the current page.
7	Save	Tap the icon to save the screenshot of the current page in the minutes.
8	Exit	Tap the icon to exit annotation mode.
9	Hide Toolbar	Tap the icon to hide or show the toolbar.

 **NOTE**

Annotation record will **NOT** save automatically, users have to press the “**Save**” button to save the needed record to “**Meeting Minutes**”.

## 5.1.2 Source

### 5.1.2.1 Wired Projection

Tap the “” icon on the toolbar at the bottom of the homepage to show the projection toolbar (Wireless Projection, HDMI 1, HDMI 2, VGA, and Type C), and tap the port corresponding to the external device to enter the projection screen, as shown below.

Input sources includes HDMI 1, HDMI 2, VGA, and Type C. If the corresponding port has a signal input, the icon of the source port is white. If the corresponding port has no signal input, the icon is gray. The user can tap the icon of any source port and the machine will display the signal source on full screen.



For Windows and Mac devices, connect with the “**USB Touch**” interface to gain touch control of the PC on the UCD screen. By connecting to the “**USB Touch**”, the PC can also access the UCD’s Camera, Microphone, and the attached device.



## 5.1.2.2 Wireless Screen Sharing

The machine is pre-installed with a wireless screen sharing feature. With this app, the documents, Word, Excel, audio, and video files of the mobile phone, tablet computer, and laptop can be wirelessly transmitted to the machine. No matter which method, the projection device and the machine must be on the UCD hotspot network.

Follow the instructions on the Wireless Screen Sharing page to cast devices from Windows, Android, Mac, and IOS platforms.

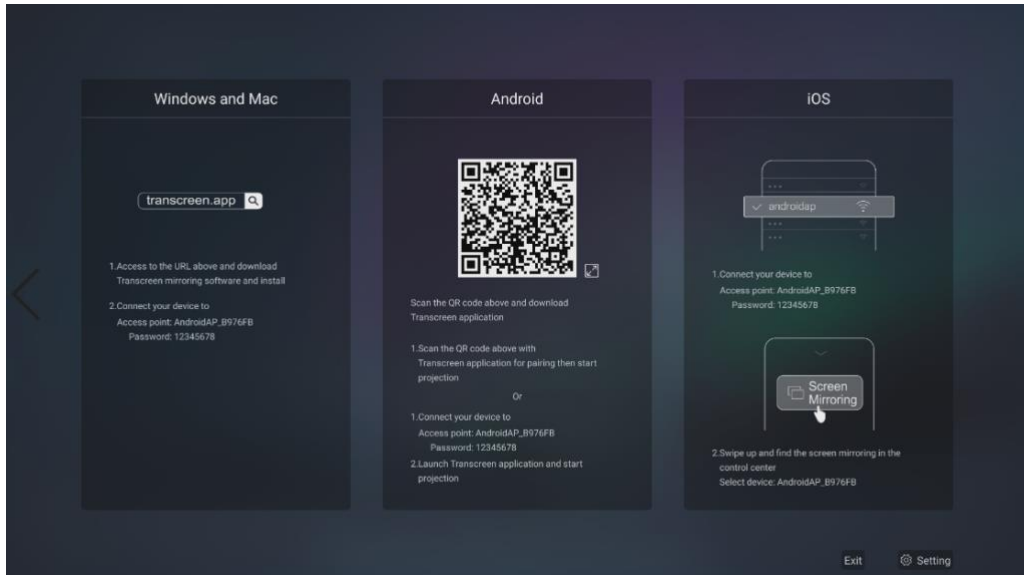

### NOTE

- *The hotspot name and password in this manual are only examples. The user needs to connect to the actual hotspot access point name on his or her machine. Machine Hotspot name and password can be changed under “Settings > Network > Hotspot Setting”.*
- *We suggest using the wireless screen sharing feature under the LAN network, 2.4G Wi-Fi network, or no network connection to the UCD. Using the wireless screen sharing feature under the 5G Wi-Fi network connection might affect stability during the projection.*

### PC Projection

**Step 1** Turn on “**Wireless Screen Sharing**” page. For first time user, follow the Windows and Mac projection guide and download Transcreen mirroring software and install onto your PC.

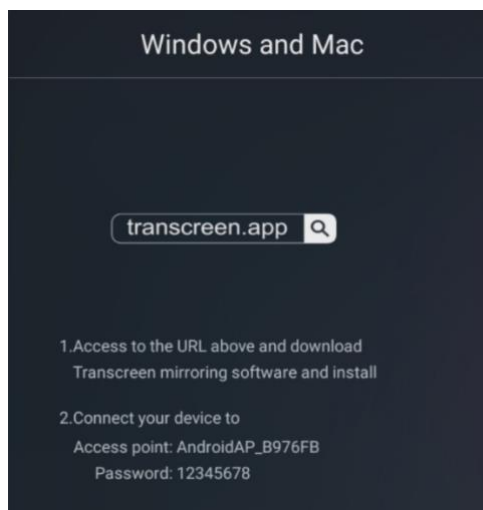

Step 2 After you have successfully downloaded Transcreen mirroring app, connect your device to the machine hotspot access point.

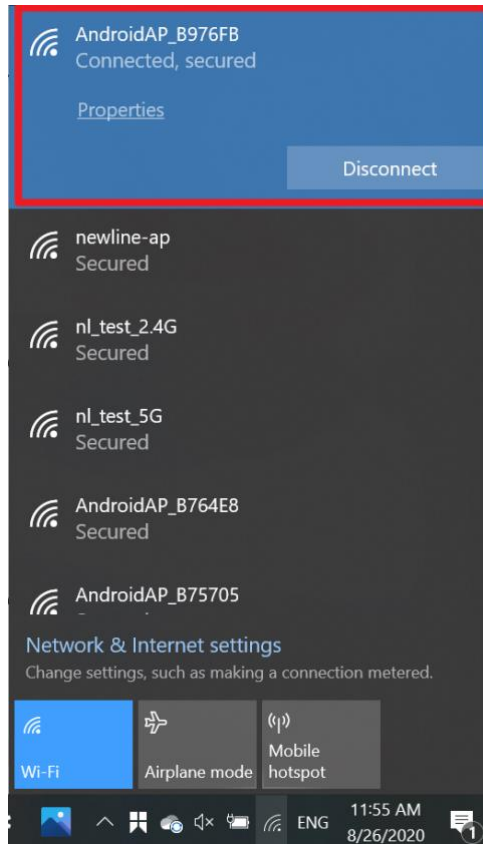

Step 3 Click Transcreen Client icon “” on your Window or Mac to open the Wireless projection page. If your computer has successfully connected to the machine’s hotspot access point, the hotspot’s name and IP address will be shown on “**Device List**”. You may click on “**Start projection**” to wirelessly project your Windows or Mac device.

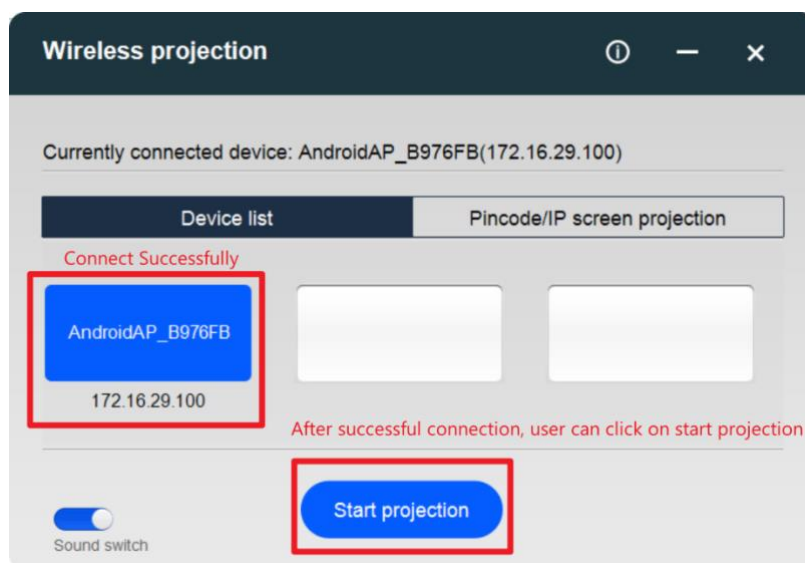



The PC has successfully projected onto the machine.

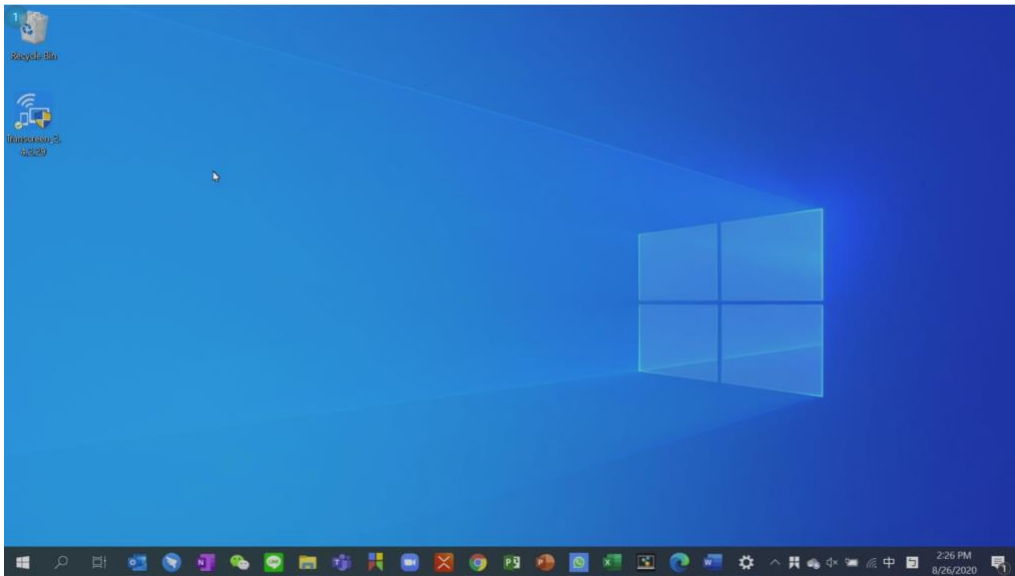

 **NOTE**

The number “

44

□ **Android Projection**

Step 1 Turn on “**Wireless Screen Sharing**” page. For first-time users follow the Android projection guide and scan the QR code to download the APP and complete the installation.

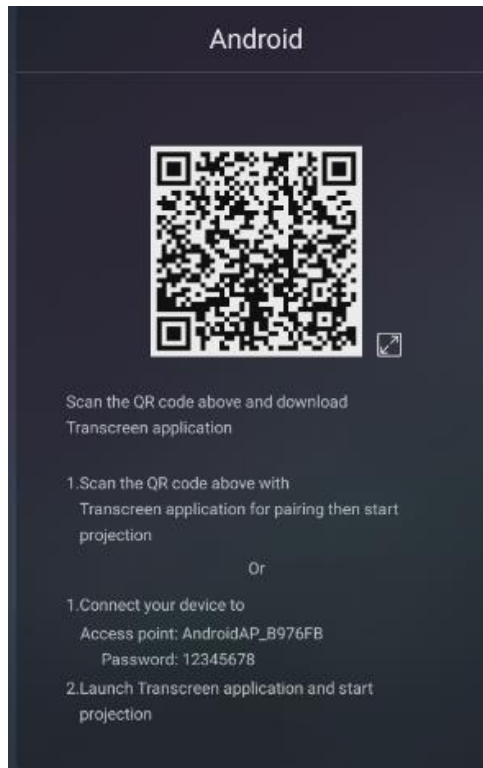

Step 2 Connect your android device to the machine hotspot access point

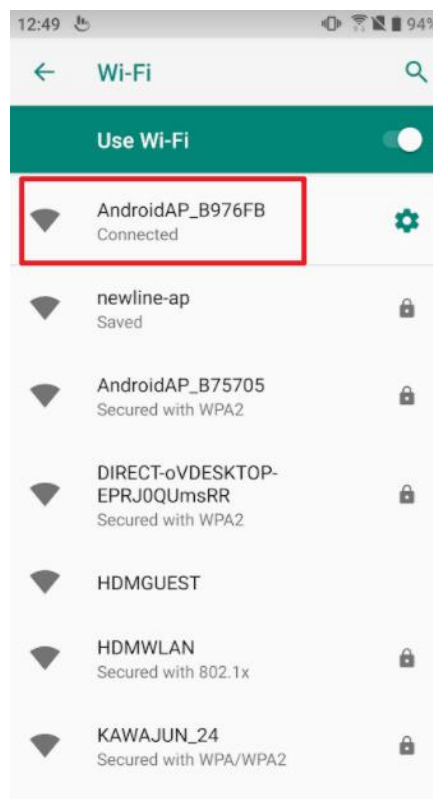

Step 3 Open Transcreen app and tap “Select Devices” to bring up the “Select for device” menu and select the access point name and tap “confirm”. The Android device will connect to the machine.

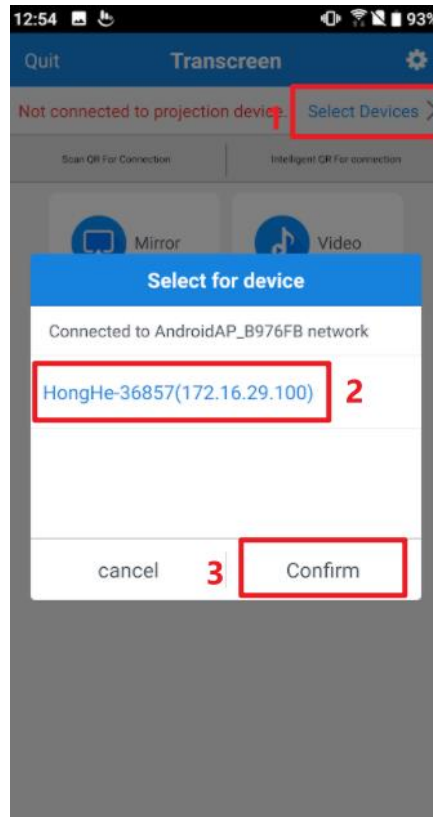

Step 4 Tap the Mirror Icon to start wireless projection.

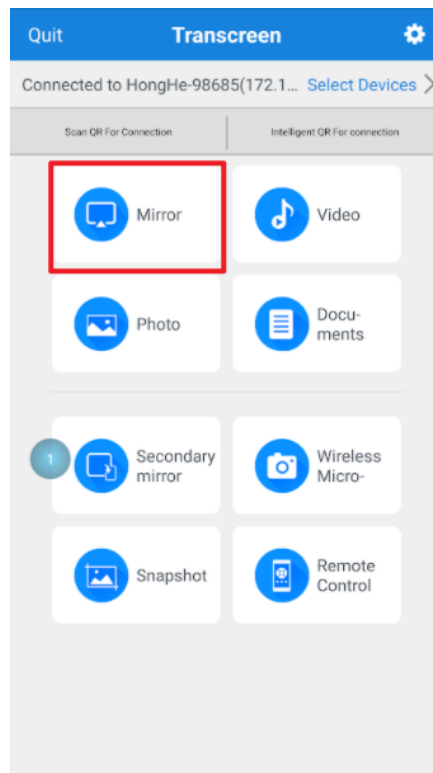

The android device has successfully projected onto the machine.

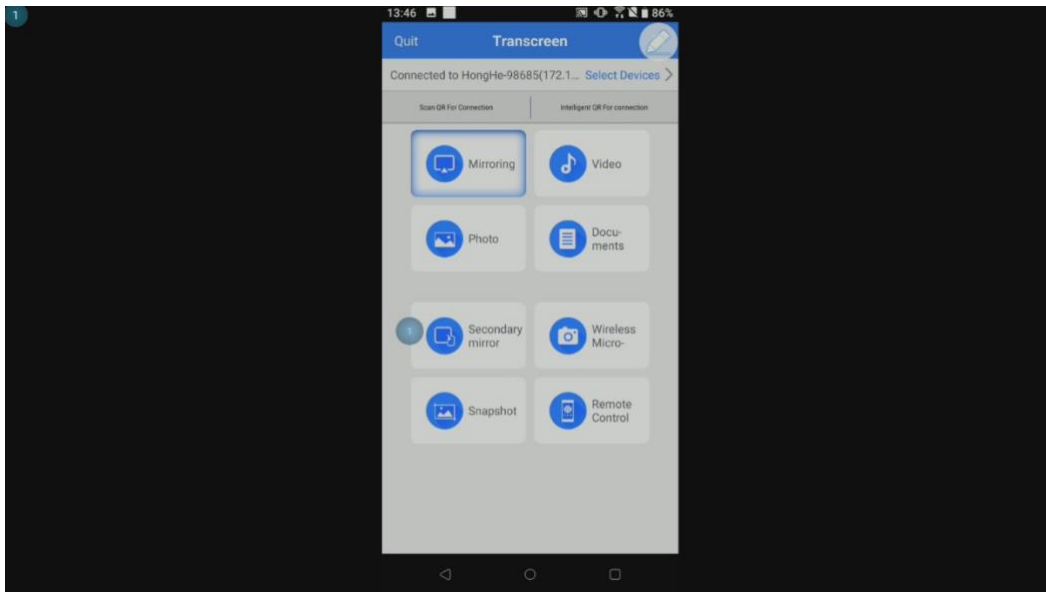

**NOTE**

*The audio will not transfer to the UCD during the projection of the Android device due to Android system limitations.*

**IOS Projection**

Step 1 Turn on the “**Wireless Screen Sharing**” page and follow the IOS projection guide.



Step 2 Connect your IOS device to the machine hotspot access point.

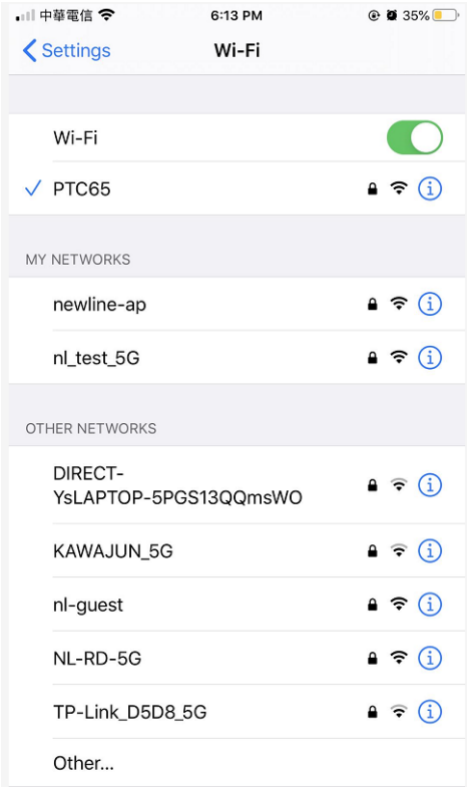

Step 3 Enter the shortcut setting of your IOS device and tap on “Screen Mirroring” to start mirroring.



Step 4 Click on the machine’s hotspot access point name to connect to the machine initiate the projection. A checkmark indicates a successful connection.



### □ Wireless Screen Sharing Settings

On the “Wireless Screen Sharing” page, tap the “Setting” button in the lower right corner to enter the setting page, as shown below:

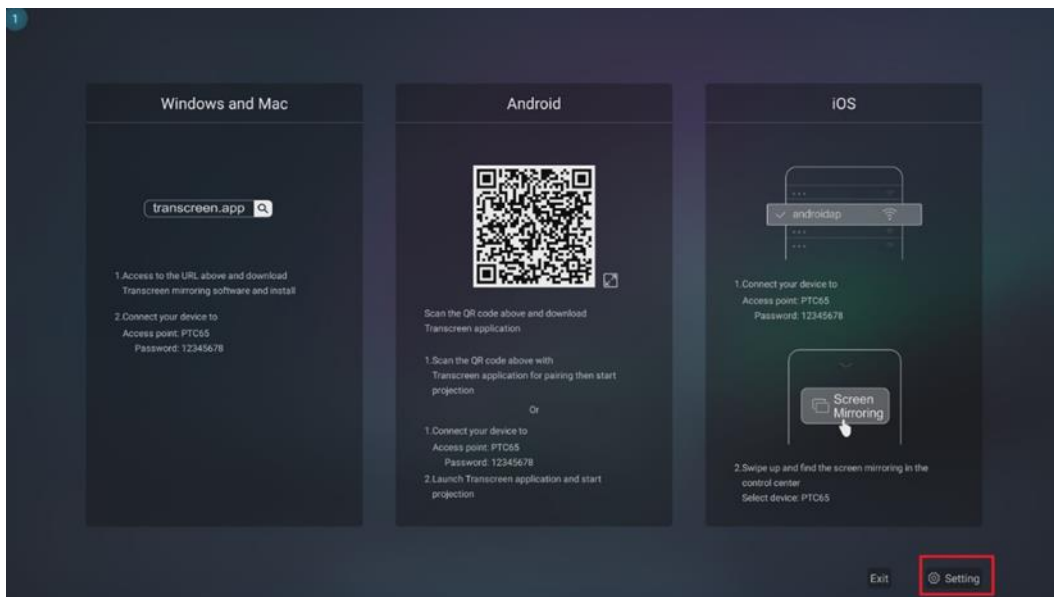

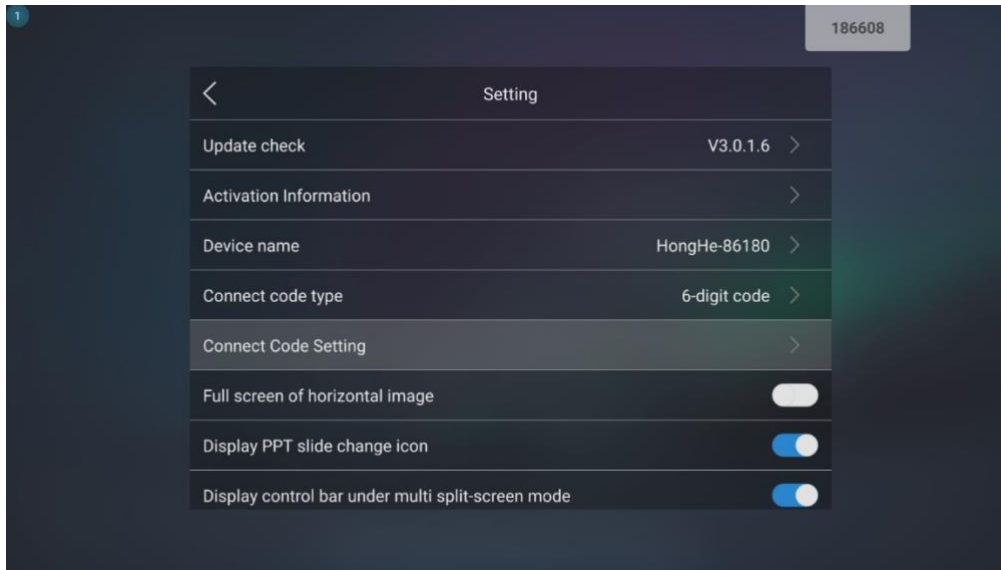

The user can perform the following operations: tap on the > icon for more information or action.

- **Update check:** see if there is a newer version for the upgrade.
- **Activation Information:** See relative information regarding the license activation. (Your machine should already come with commercial activation.)
- **Device name:** See the default device name.
- **Connect code type:** Set connect code type as a password before a device can wirelessly project to the machine
  - 6 digit code: 6 digit random numbers. Example 238482
  - 6 digit universal code: 6 digit random numbers and English letters. Example 1QE38A
  - 8 digit universal code: 8 digit random numbers and English letters. Example 38A91ZG3

**Connect Code Setting:** To close and open the connect code, when open please also enable “**Show Floating Bar**” to have the connect code to be always floating.

 **NOTE**

*Floating Connect Code bar may block and interfere with the UI of other apps.*

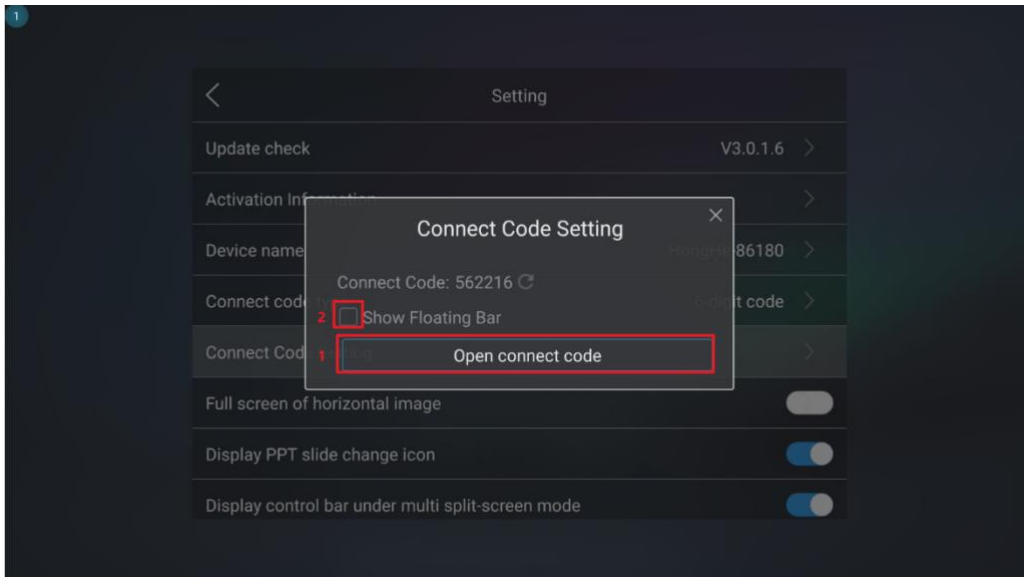

- **Full Screen of horizontal image:** When enabled will stretch a horizontal image to occupy the entire screen (IPAD only)
- **Display PPT slide change icon:** To enable and disable a toolbar for control slide changes for PPT (PC Only)
- **Display control bar under multi split-screen mode:** To enable and disable the control bar on top of each split screen.
- **The third split-screen will be displayed on bottom center:** To better utilize screen space, the third split-screen will occupy the bottom half portion instead of just 1/4<sup>th</sup> of space.
- **Display Master control ball:** To enable or disable the master control ball which controls the wirelessly projected devices.
- **Reverse control devices under multi split-screen mode:** To enable or disable reverse device control.
- **Set the quantity of split-screen:** Single full Screen, dual Screen, or four screens



### 5.1.3 File Commander

Tap the “” icon in the bottom toolbar to enter the File Commander. The interface displays the content of local files of the current system. If any external mobile devices (such as USB storage devices, removable hard disk, etc.) are connected, the file content of the mobile device will be displayed at the same time.

Enter the Files application, you can click the submenu at the left side according to requirements, preview internal storage, external storage devices connected via the USB ports, cloud-stored files, FTP uploaded files, and local network files, as shown in the following figure.

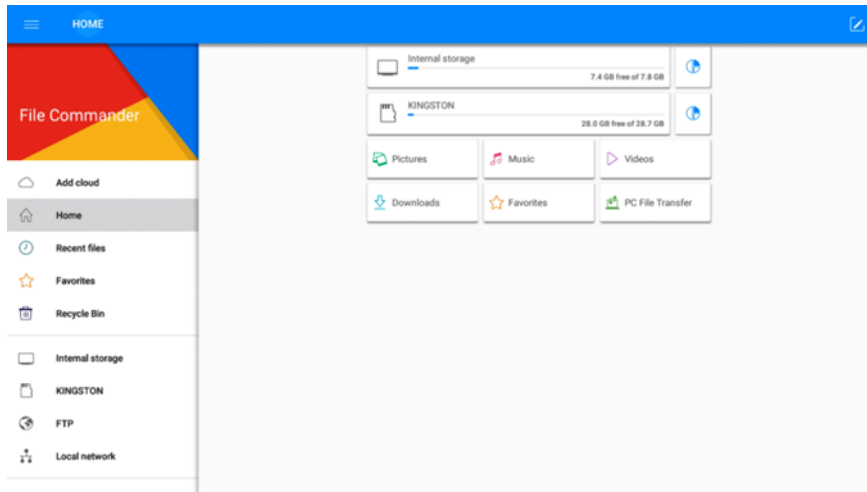

#### File Management

The machine supports connection to USB flash memory. Enter the File application, you can preview all files in the internal storage and storage devices connected via USB ports and select, copy, paste, delete, and search for files.

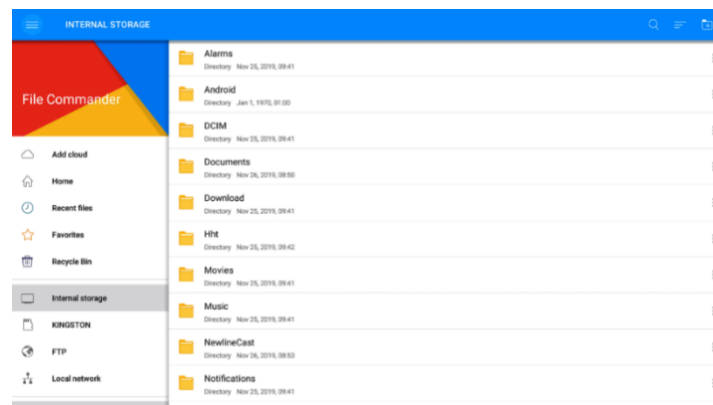

□ File Filtering

You can click the menu at the left side to display files by types, for example: **Documents**, **Pictures**, **Music**, **Videos**, **Archives**, and **Downloads**.

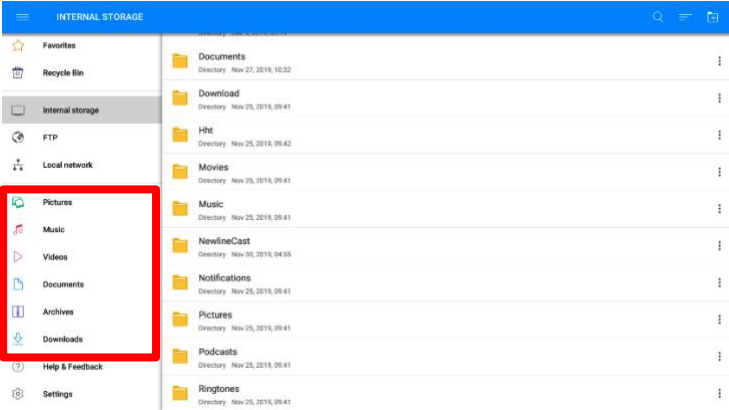

You can also click “” at the top right corner to filter files by View mode, Sort by, show only.

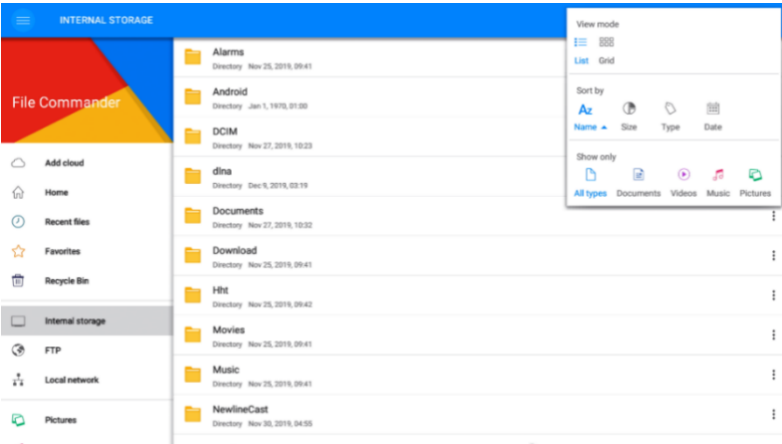
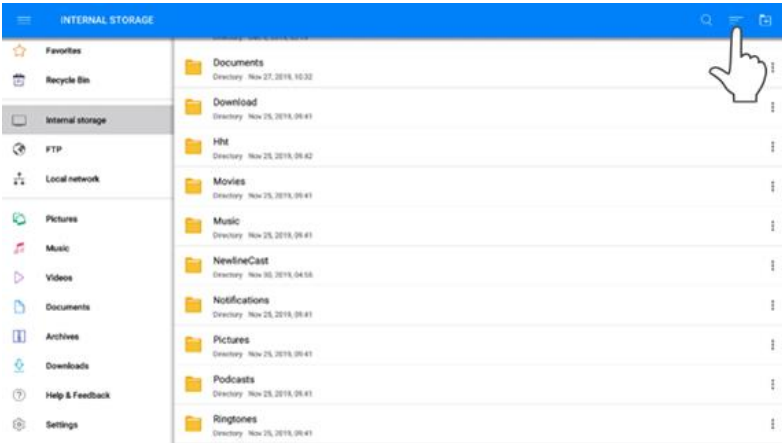

## □ File Search

Enter the Files application, and click “” in the dialog box that is displayed, enter keywords in the search box according to requirements. The system will display a list of files that match the keywords.

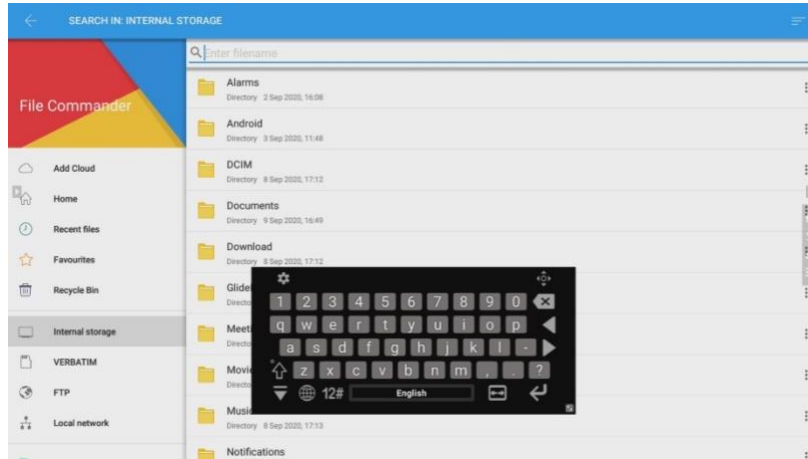

## □ File Operation

Enter the Files application. You can create folders according to requirements, select files, and set rename/move/copy/cut/delete/open as/share/zip. For details on other operations, click “” in the right side for more operations.

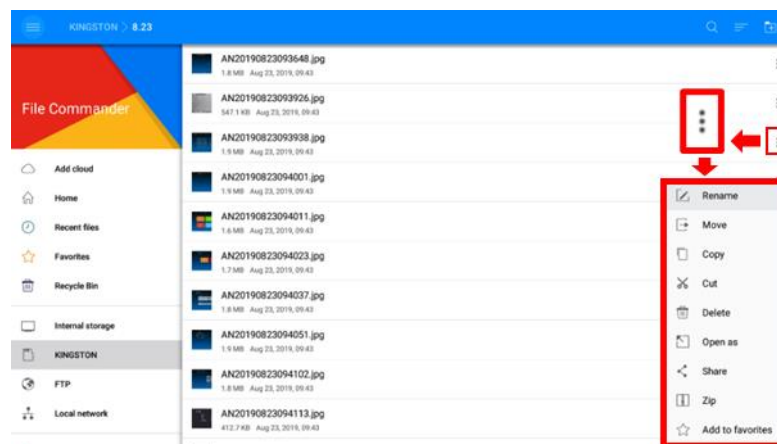

## 5.1.4 Windows (OPS Pluggable PC Needed)

After the OPS (built-in computer) is successfully installed on the machine, the Windows icon will appear on the bottom toolbar. The user can tap the Windows icon to enter the Windows interface, as shown below:

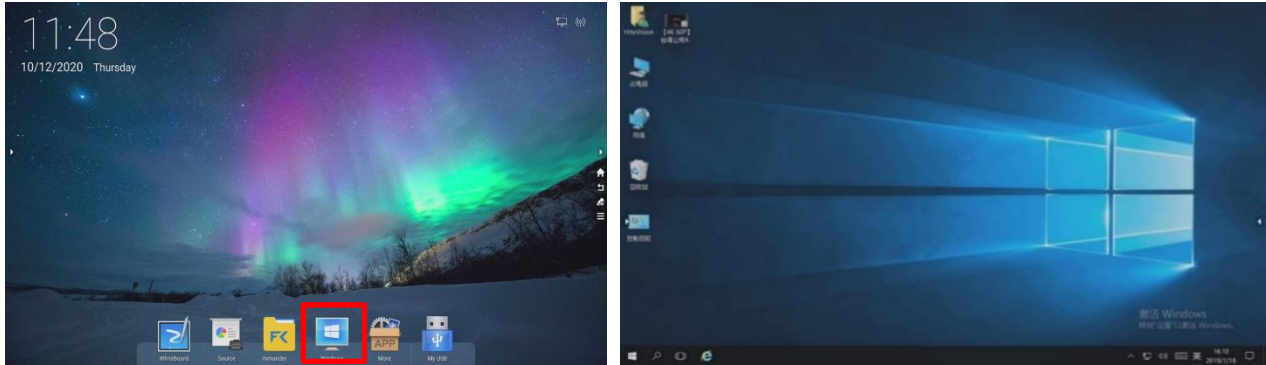

## 5.1.5 More

Tap the “” icon on the bottom toolbar to enter the app list interface, as shown below:

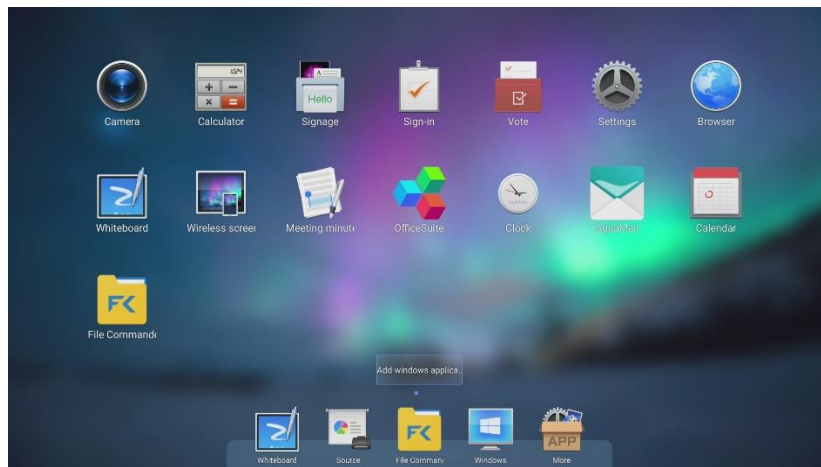

The default application included: Camera, Calculator, Signage, Sign in, Vote, Setting, Browser, Whiteboard, Wireless Screen Sharing, Meeting Minutes, Office Suite, Clock, Aquamail, Calendar & File Commander. For more details of each app, please refer to **section 5.2**.

Users can edit the layout or uninstall the app by entering the app editing mode. For more details, please refer to **section 4.5**.

### 5.1.6 My USB (USB flash drive needed)

After the USB flash drive is successfully plugged into the machine USB port, the “My USB” icon will appear on the bottom toolbar. The user can tap the “My USB” icon to enter the “File Commander” and quick access with the file in the USB flash drive as shown below:

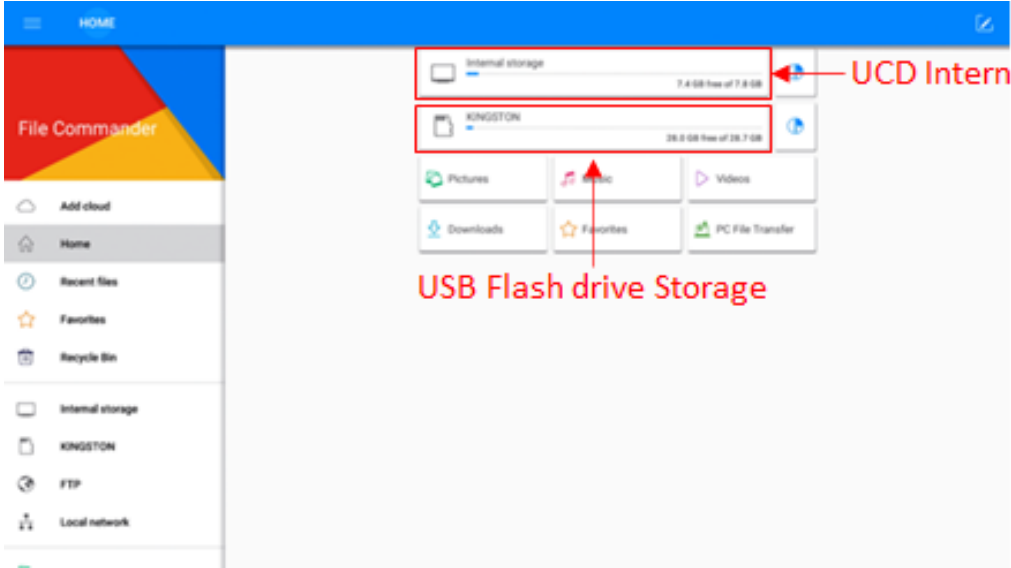
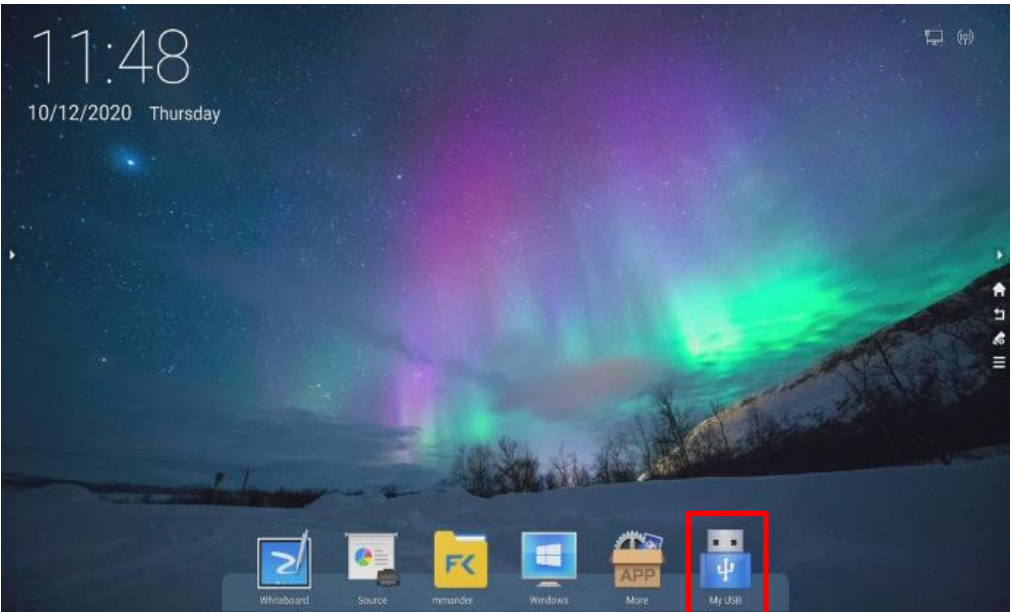

## 5.2 “More” (App List Interface) - Default Applications

Tap the “” icon on the bottom toolbar to enter the app list interface, as shown below:



The default application included: Camera, Calculator, Signage, Sign in, Vote, Setting, Browser, Whiteboard, Wireless Screen Sharing, Meeting Minutes, Office Suite, Clock, Aquamail, Calendar & File Commander.

### 5.2.1 Camera

Tap the “” icon to enter “**Camera**”:

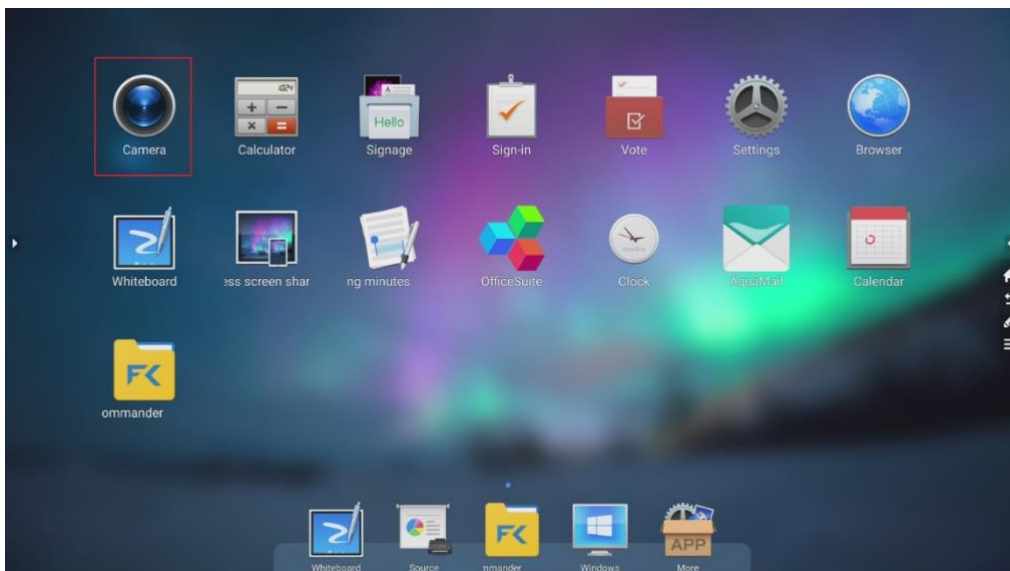

Swipe right to access the menu for the picture or video taking.



When taking a video, audio will automatically be recorded

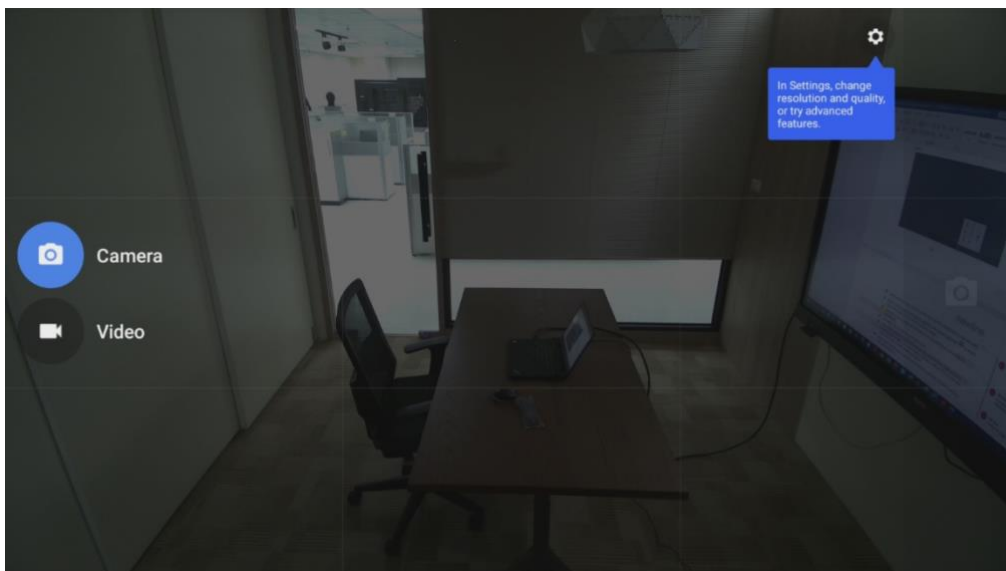

**NOTE**

- *Video recording cannot be used at the same time as Screen Recording. If Screen recording is already activated, video recording will not be turned on.*
- *Image and video took by Camera will be saved in: File Commander -> DCIM -> Camera*

## 5.2.2 Calculator

Tap the “” icon to enter “**Calculator**”:





### 5.2.3 Signage

Tap the “” icon to enter “**Signage**”:

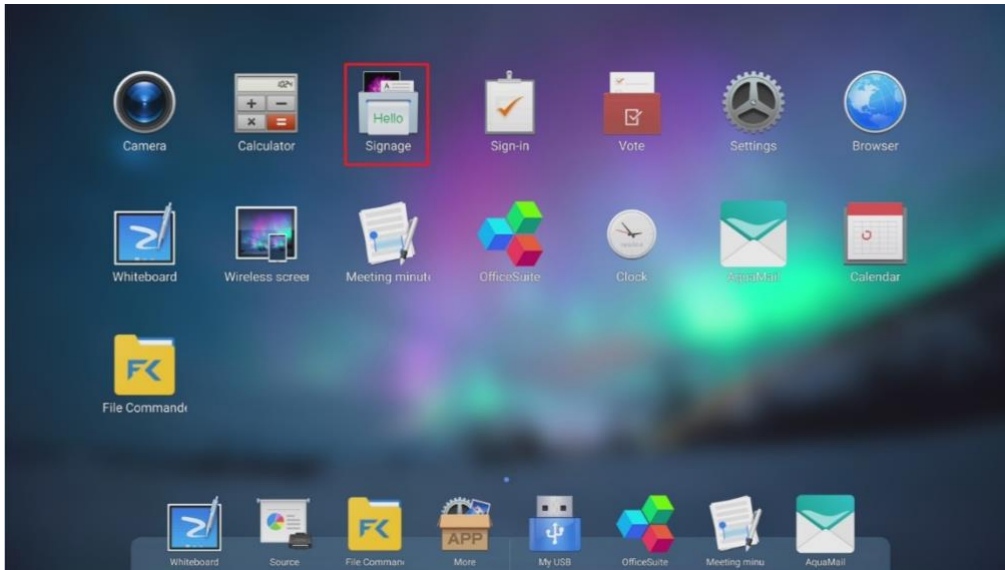

The “**Select Template**” page will pop up. In this page, the user can select the desired template style and customize welcome words under “**Default**” or “**Save File**” mode, as shown below:

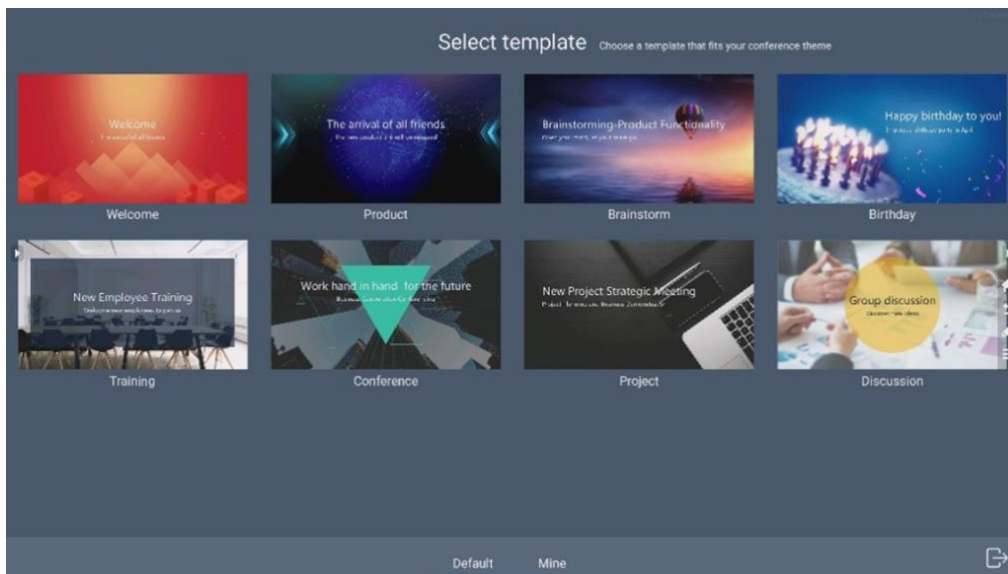

After selecting a template, enter the template editing interface:

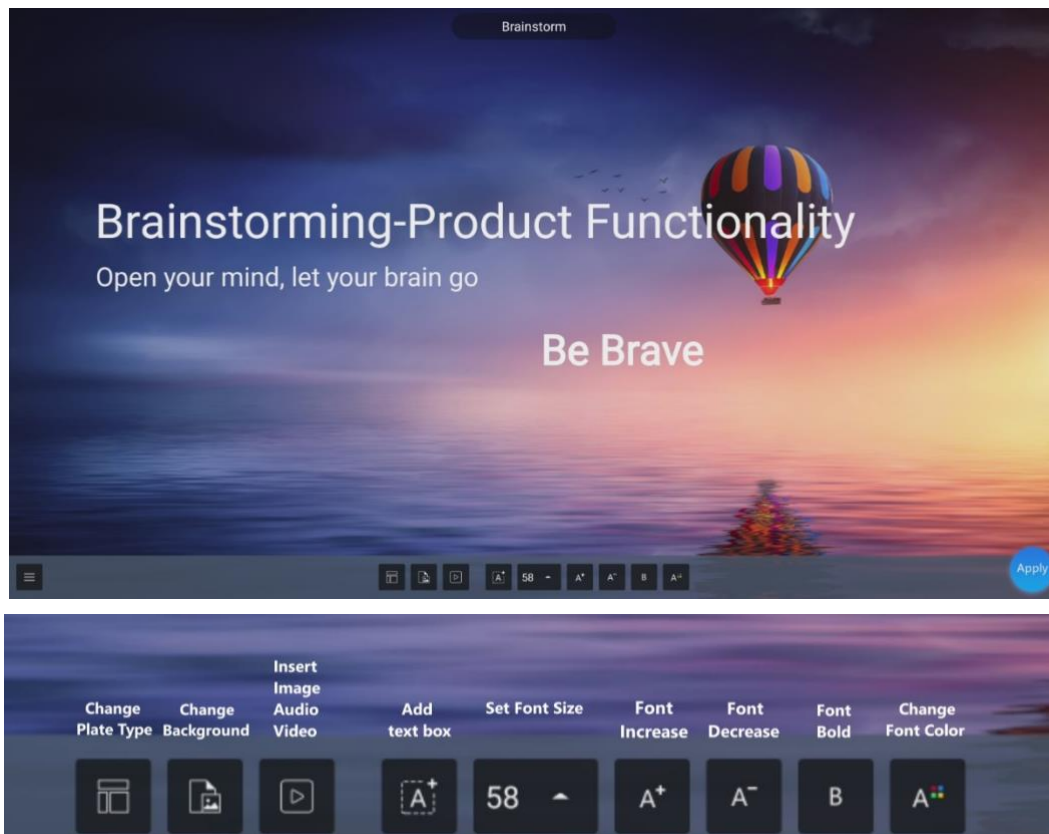

After editing the template, the user can tap the “**Apply**” icon in the lower right corner to save into “**Save Files**”, or tap the “” icon in the lower left corner to perform the following operations:

- Tap “**Restore**”: Restore the template to the default mode prior to editing.
- Tap “**Rename**”: Modify the template name.
- Tap “**Back**”: Return to the previous operation.
- Tap “**Save**”: Save the template in “**Save File**”.

## 5.2.4 Sign In

Tap the “” icon to enter the “**Sign In**”:

Users can be acquired by scanning with third party QR scanner software under your mobile device. After the participants have signed in, the relevant information is synchronized to the sign-in form in real-time:

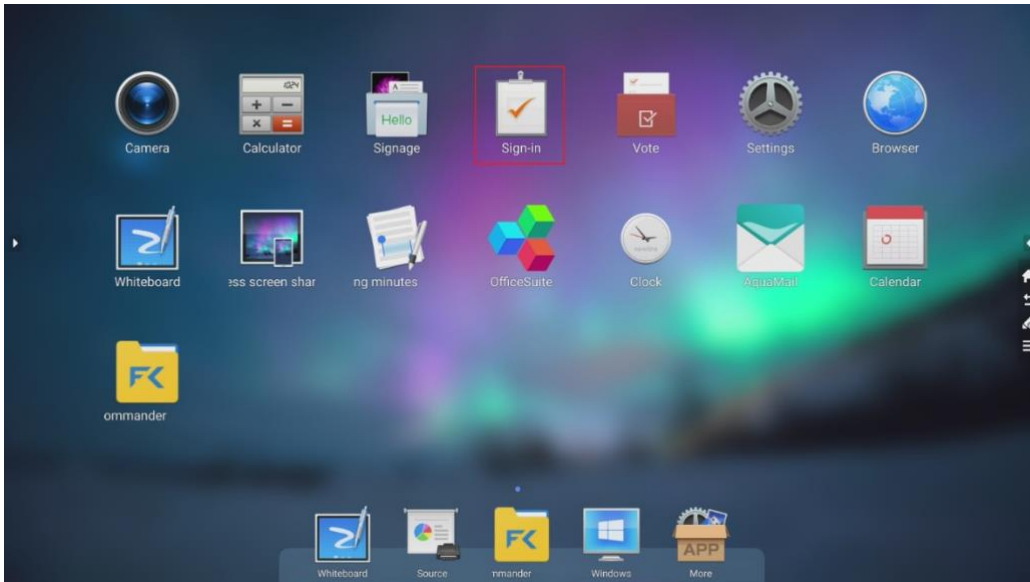

Scan the QR code with your mobile devices

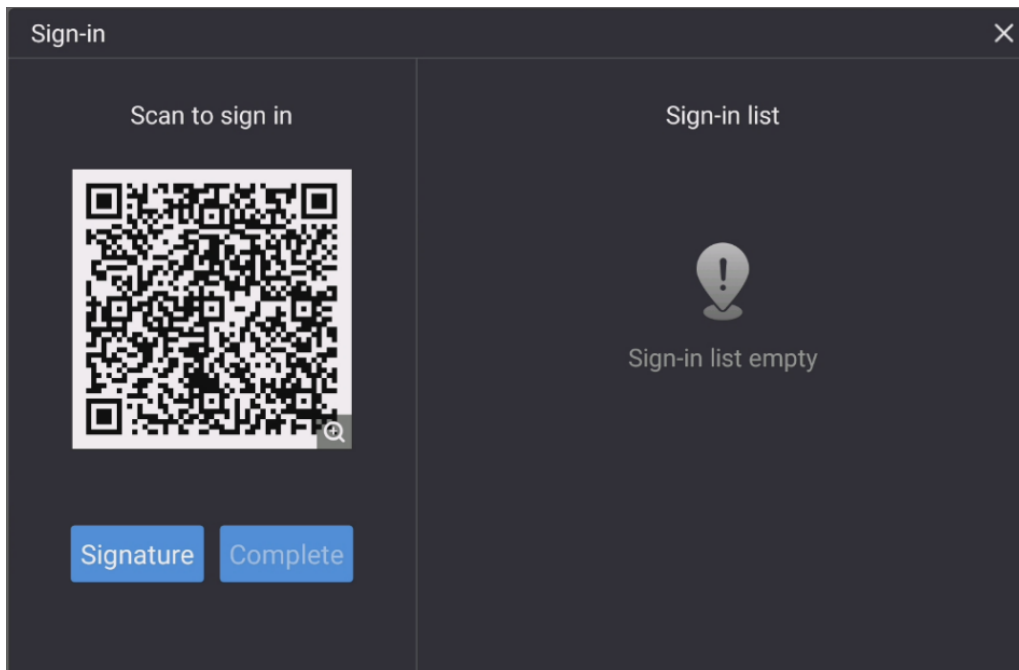

 **NOTE**

*“Sign In” only works when both the machine and the mobile device are connected to the internet.*

Your devices will be directed to a website for you to input your name, company name, and department name.

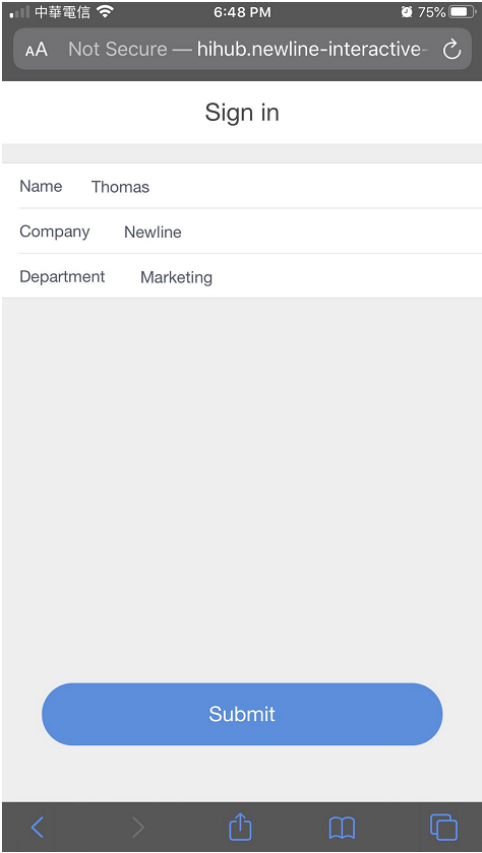

After the user tap submits from their mobile devices, their input will be shown on the Sign-in list. The meeting host can tap **Complete** to finish the signing process.

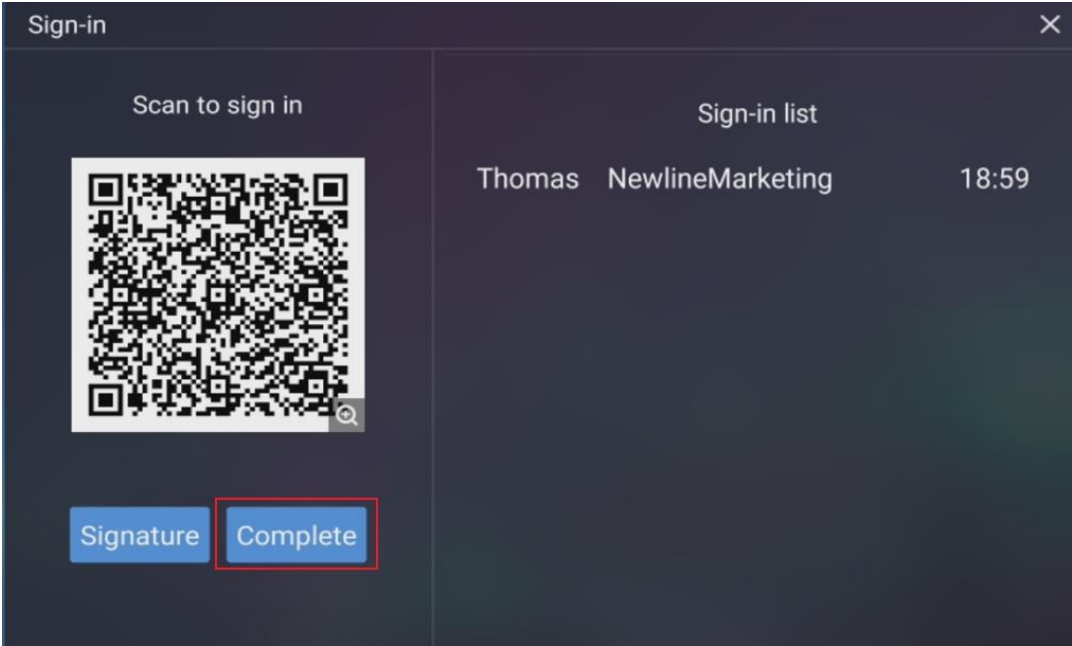

After the meeting host tap **“Complete”**, users can use their mobile device to scan the QR code to download the Sign-in List onto their mobile devices.

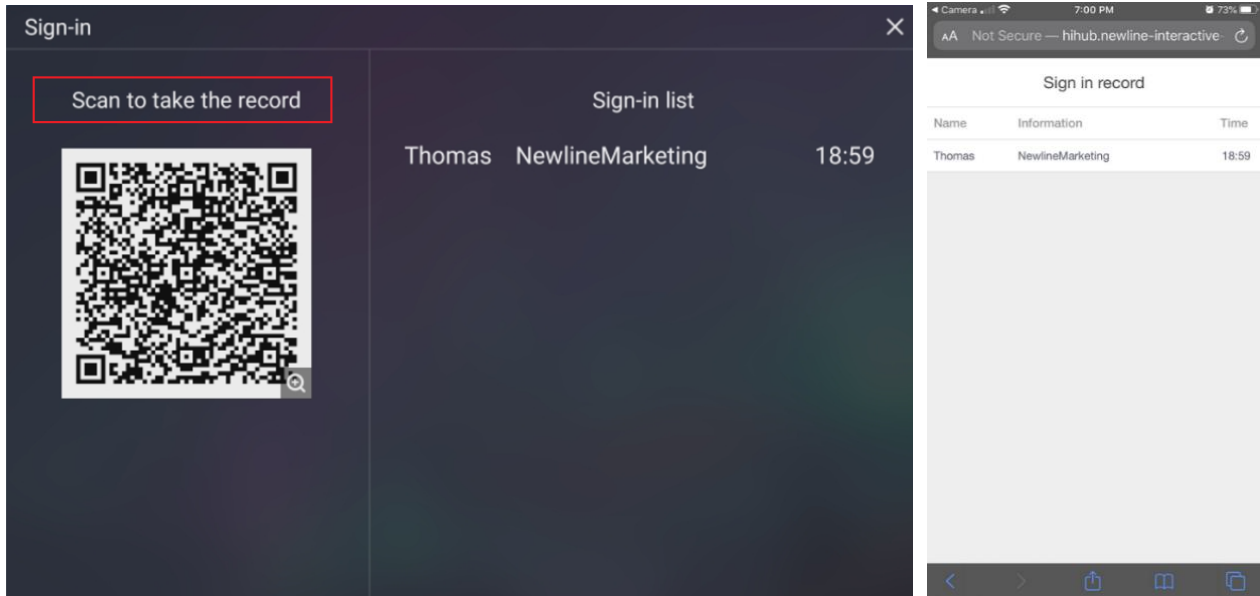

**NOTE**

The user can also select the **“Signature”** button to enter the signature interface. Handwritten sign-in can be done by hand or with a stylus. The bottom toolbar includes a pen, an eraser and background settings (customizable), etc. The sign-in interface can be saved by scanning the QR code. The user can tap the  button in the lower right corner to exit the sign-in interface.

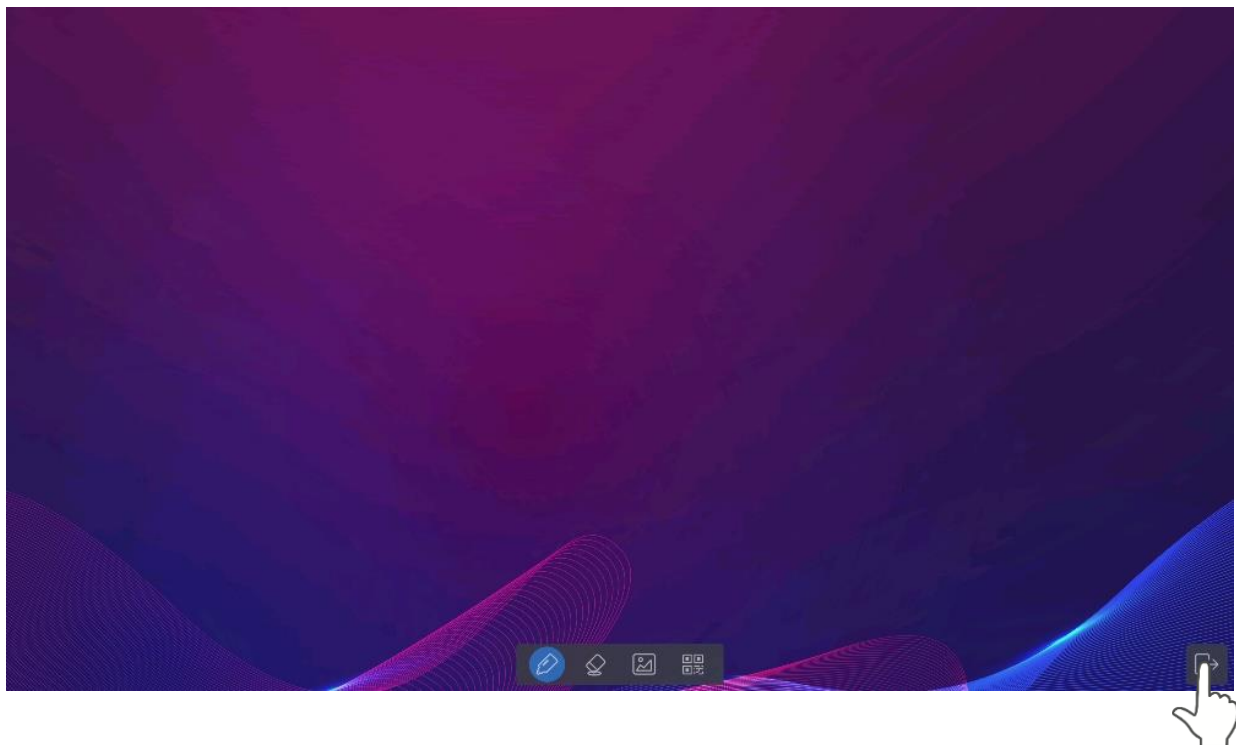

**NOTE**

If the user is idle for more than 8 seconds on the signature interface, the bottom toolbar will be automatically hidden. The users can tap the hidden button at the bottom to call out the toolbar again.

### 5.2.5 Vote

Tap the “” icon to enter “Vote”:

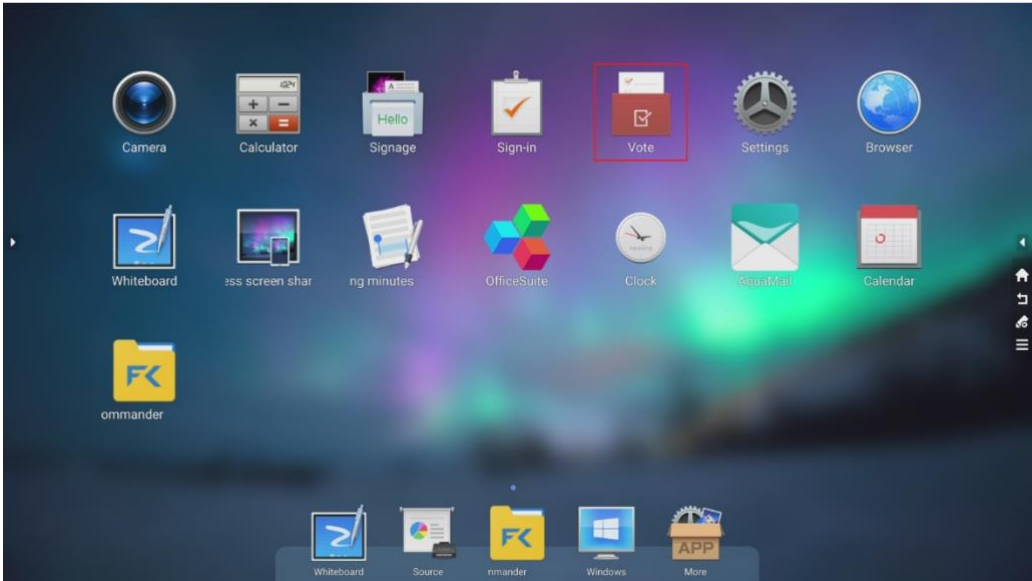

Users can input a topic (not required) and input options (2 options minimum, 10 options maximum.) After tapping “**Complete**”, a QR code is generated for users to scan with their mobile devices.

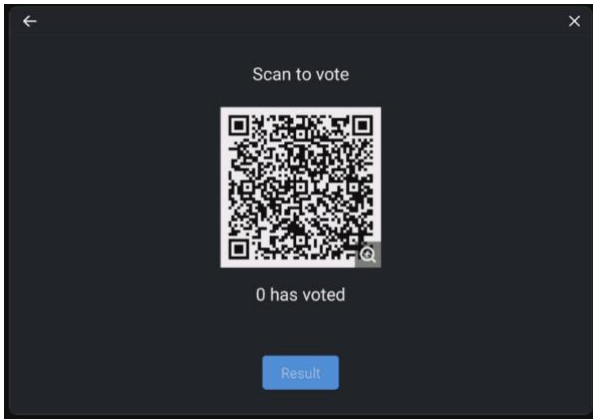
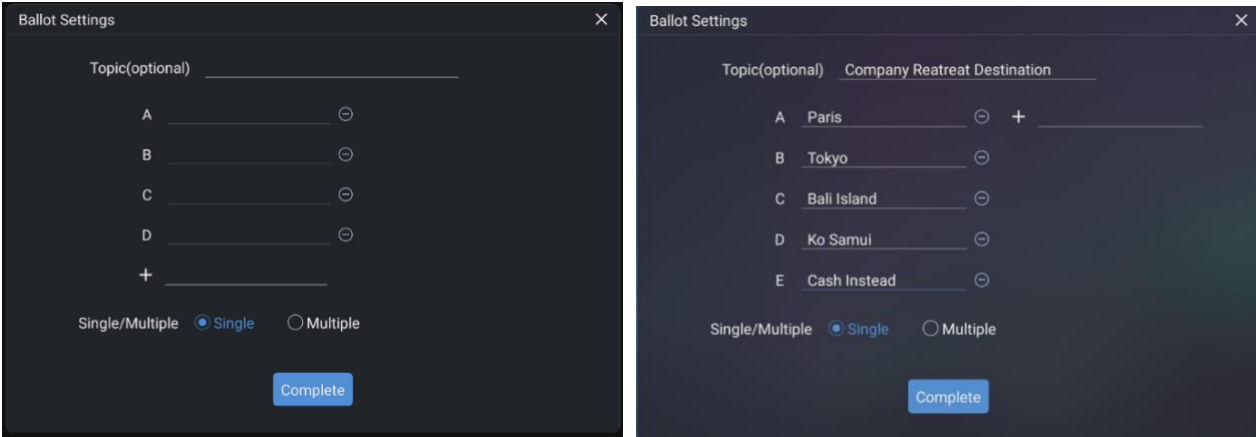

 **NOTE**

“Vote” only works when both the machine and the mobile device are connected to the internet.

User will see the voting topic and options on the mobile device after the QR code is scanned. After making the selection, tap “submit” to cast vote.

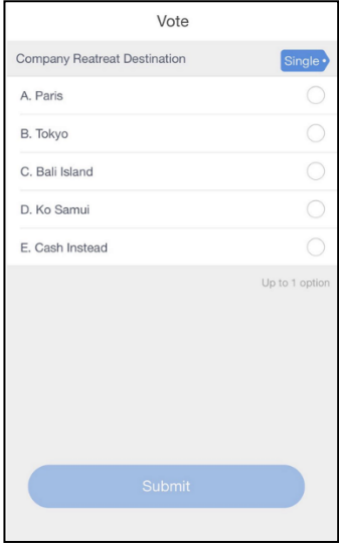

In the voting process, the number of voters is displayed in real-time under the QR code.

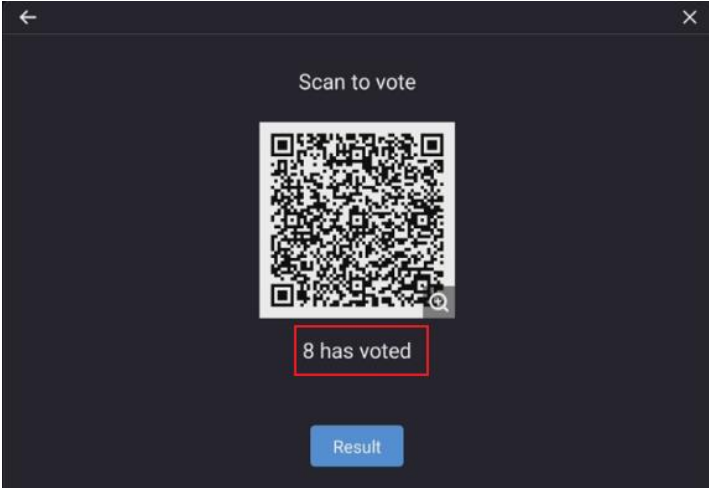

The user can tap the “Result” button to terminate the current vote process and show the voting results

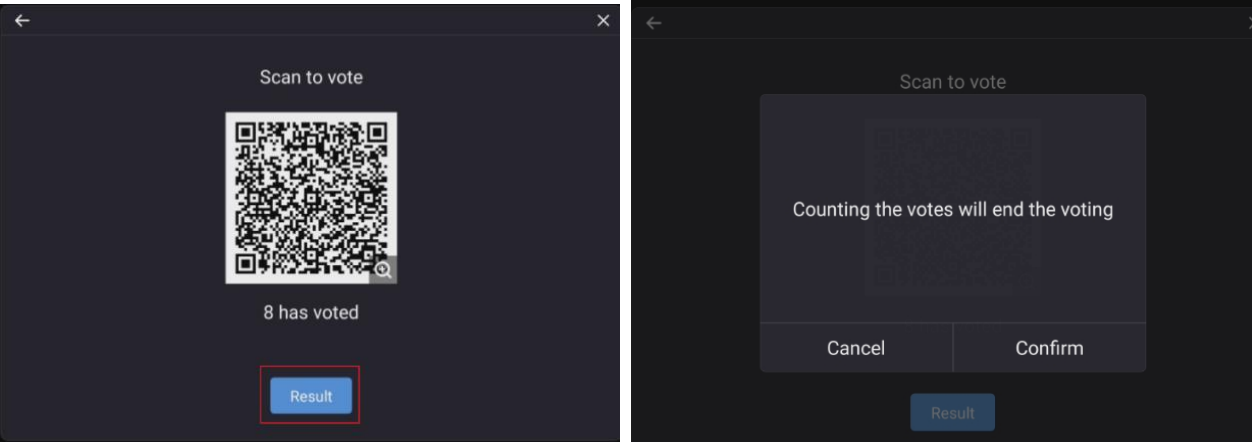

The voting results can be displayed in both the “Pie chart” or “Bar chart” form.

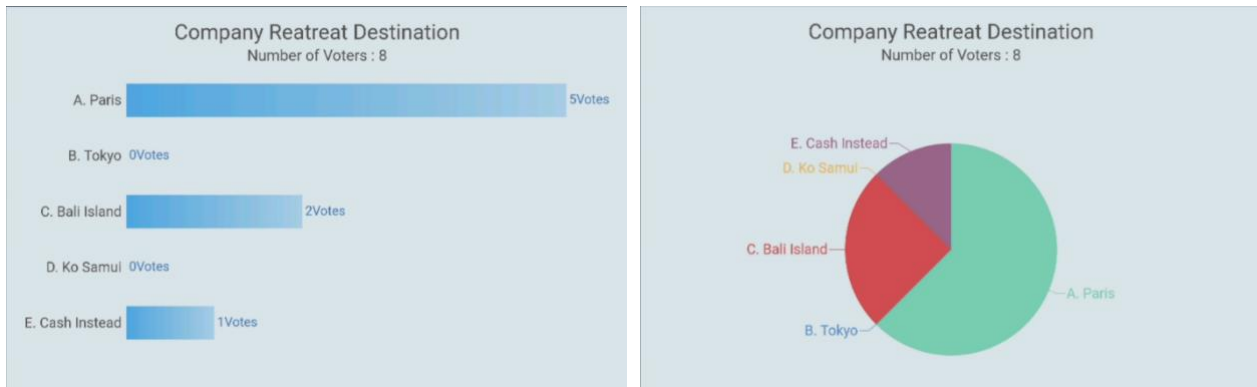

The user can tap “Insert into whiteboard” to insert the current voting results into the whiteboard.

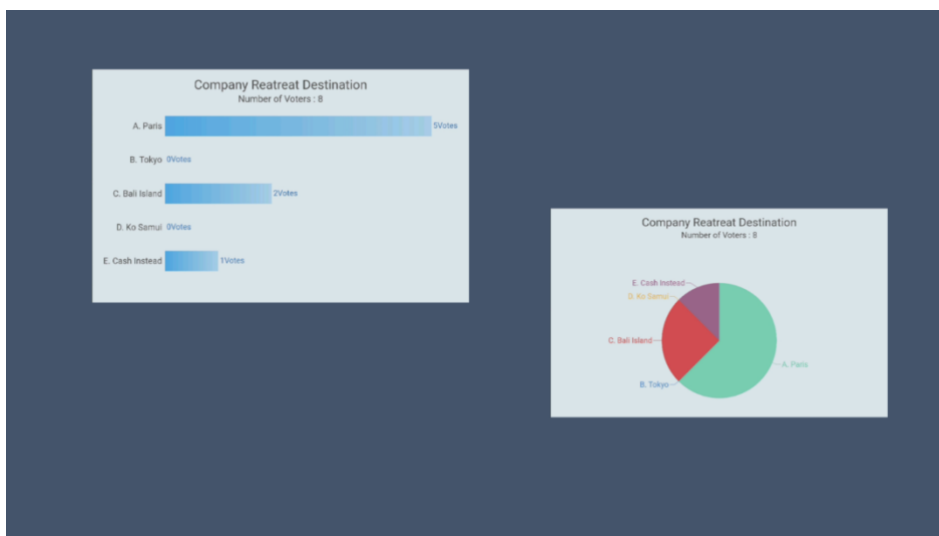

## 5.2.6 Settings

Tap the “” icon to enter the settings page. The user can set Network, Application Notification, Display, Volume, Scheduled Power-on/off and Personal settings, etc. For more details, please refer to **section 5.4**.

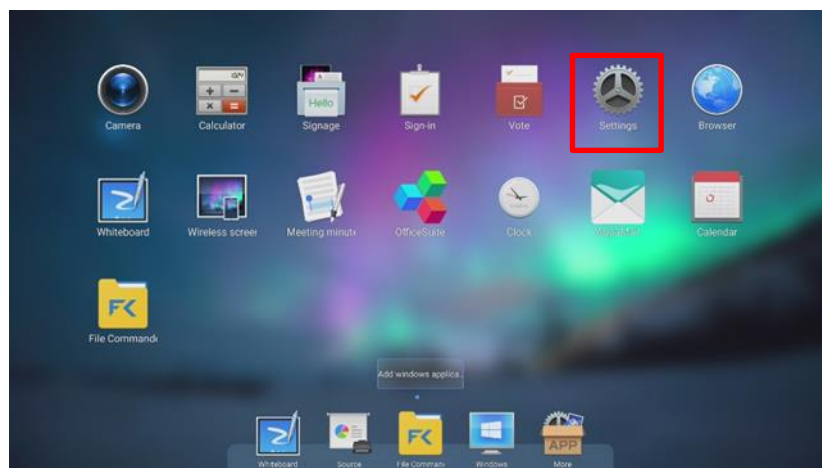



## 5.2.7 Browser

Tap the “” icon to enter the “**Browser**”:

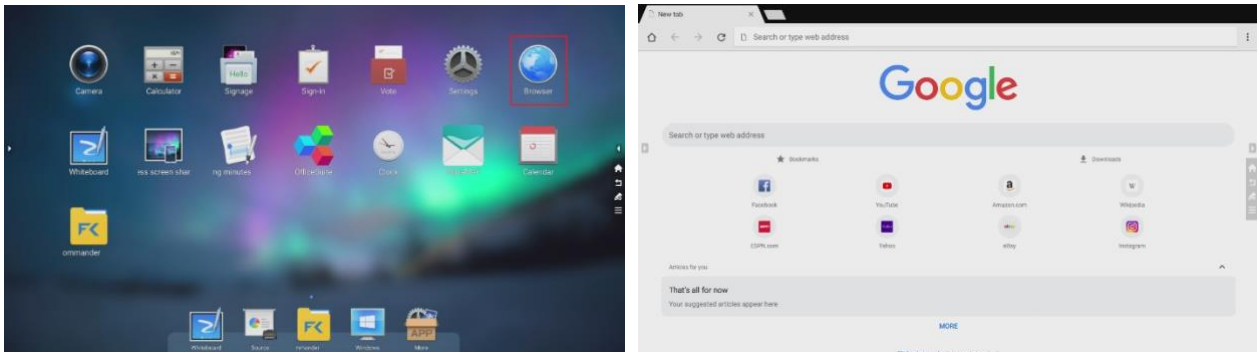

### NOTE

“Browser” only works when the machine are connected to the internet.

## 5.2.8 Whiteboard

Tap the “” icon to enter the “**Whiteboard**”, for more detail, please refer to **section 5.1.1**



## 5.2.9 Wireless Screen Sharing

Tap the “” icon to enter the “**Wireless Screen Sharing**”, for more detail, please refer to **section 5.1.2.2**

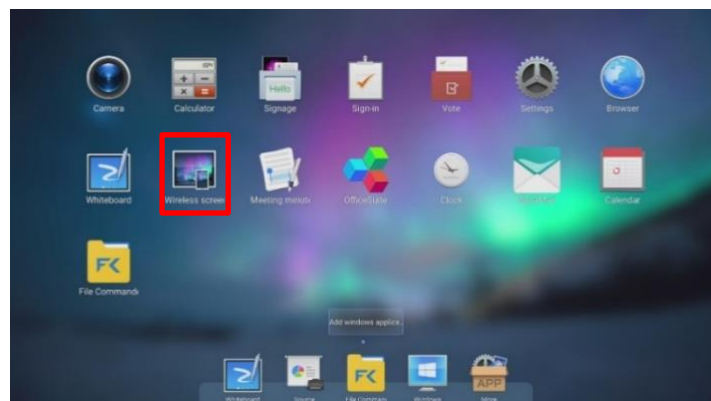

### 5.2.10 Meeting Minutes

Tap the “” icon to enter the “**Meeting Minutes**”:

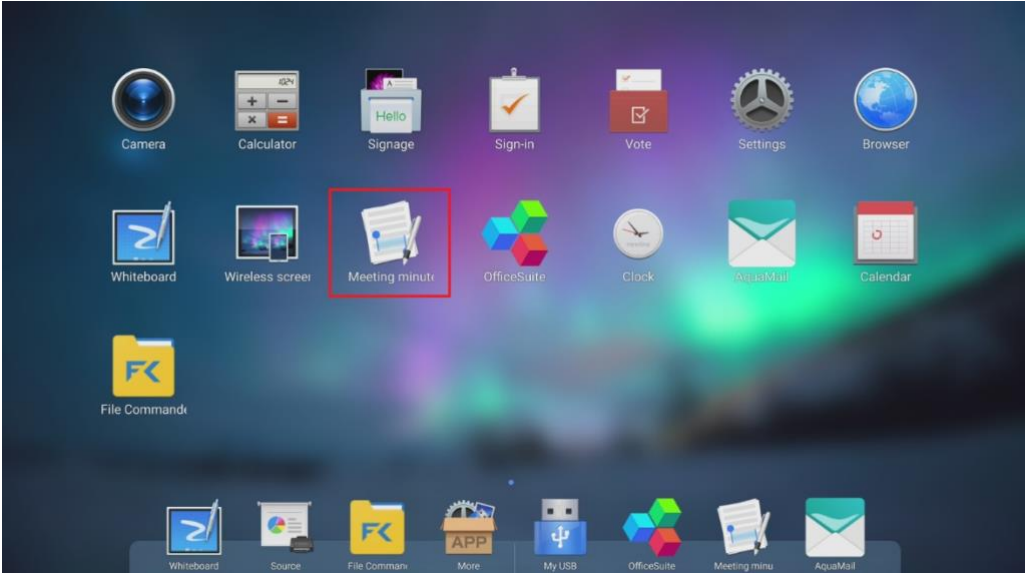

The user can filter the viewing mode and tap the “”

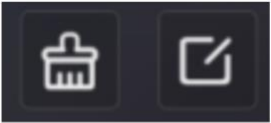
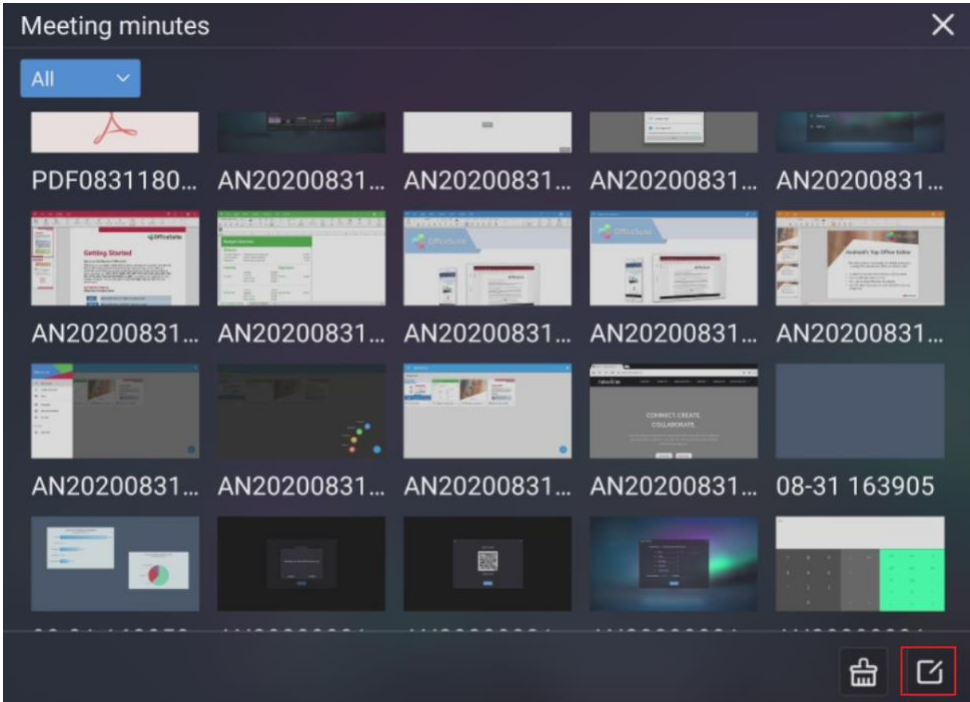

**Clear all files**      **Open file management**

Filter all the files in “Meeting minutes” by file type if you do not wish to view them all at once by tapping on the filter icon on the top left.

Tap on the corresponding checkmark to select individual files, groups of files or all files.

Tap on the image file thumbnail to open the image.

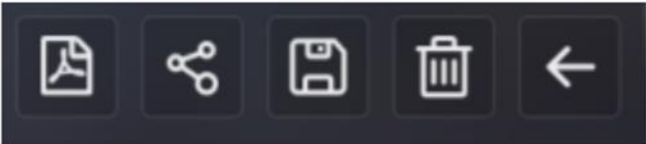
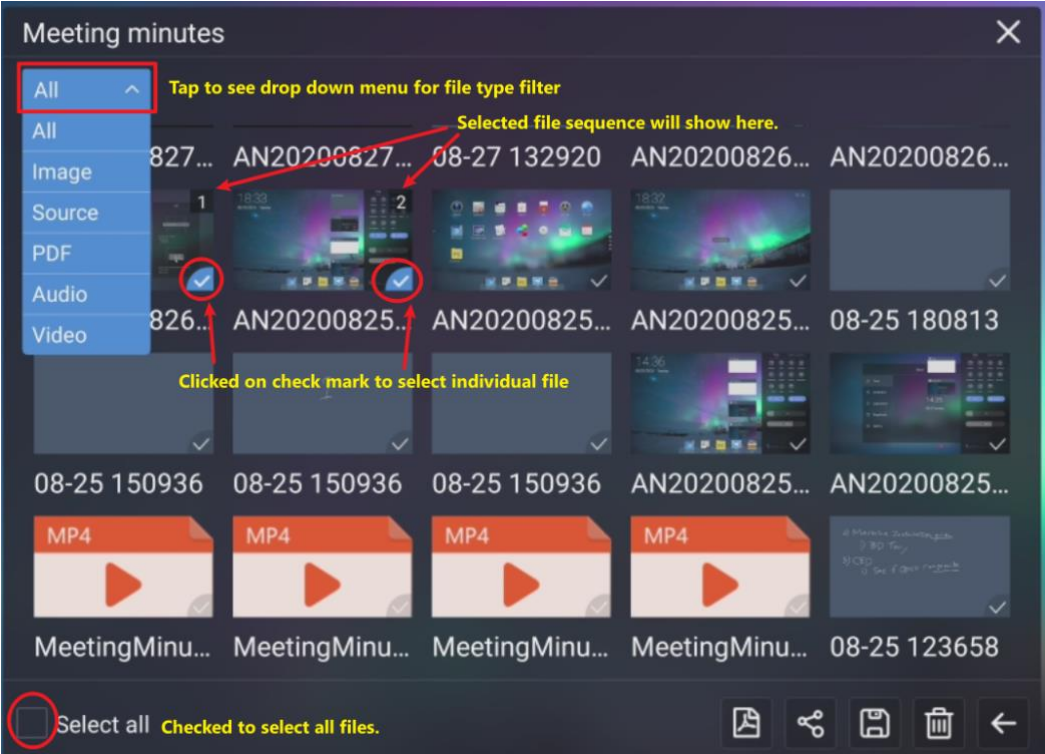

- Save selected Images As PDF
- Share by QR Code or Apps
- Save to USB
- Delete
- Return to last page

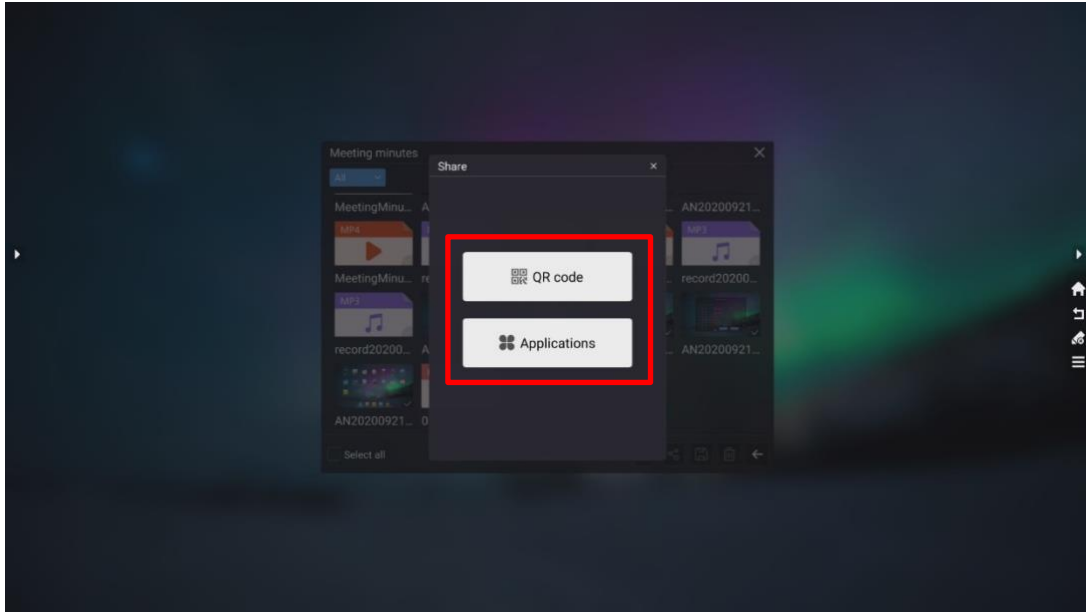

**NOTE**

- File type **“Source”** is the whiteboard native file format, which can be reopened to access the previously saved whiteboard session.
- **“Share”** by QR Code only works when both the machine and the mobile device are connected to the internet.
- Only image file could be share by QR code and application in **“Meeting Minutes”**, other file types such as PDF, video and audio file can only save to USB in Meeting Minutes, or share in File Commander

## 5.2.11 OfficeSuite

Tap the  icon to enter the **“OfficeSuite”**:

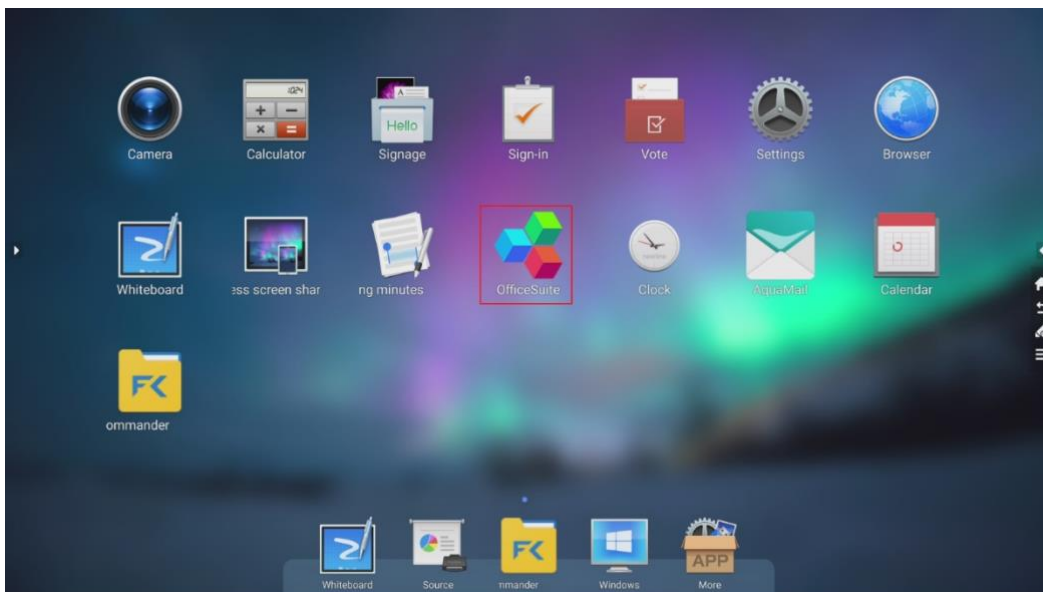

OfficeSuite able to View, Edit and Save Word, Excel, PowerPoint and PDF document

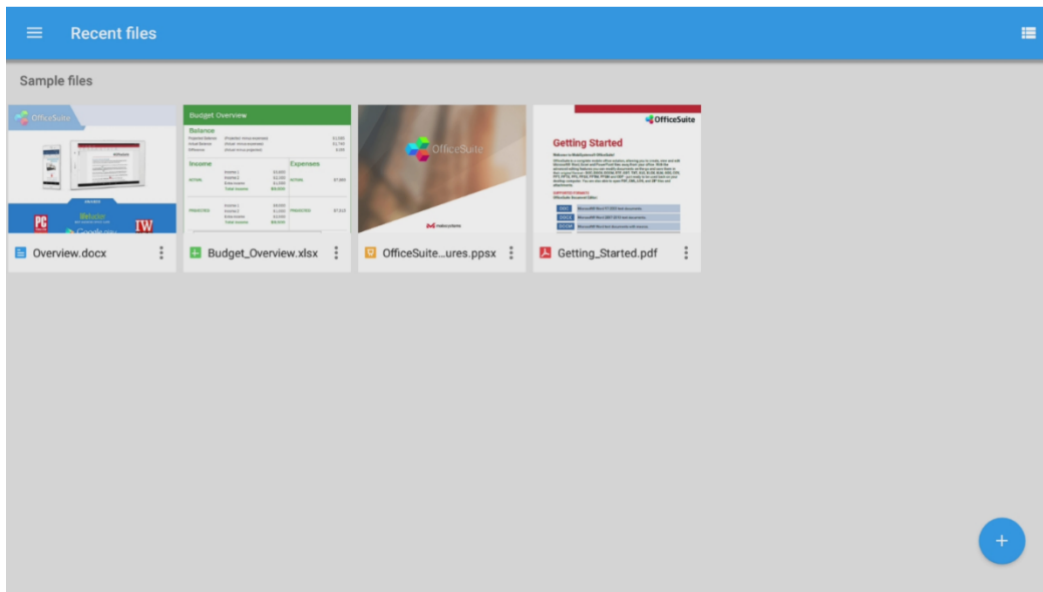

Press  to start edit of the document

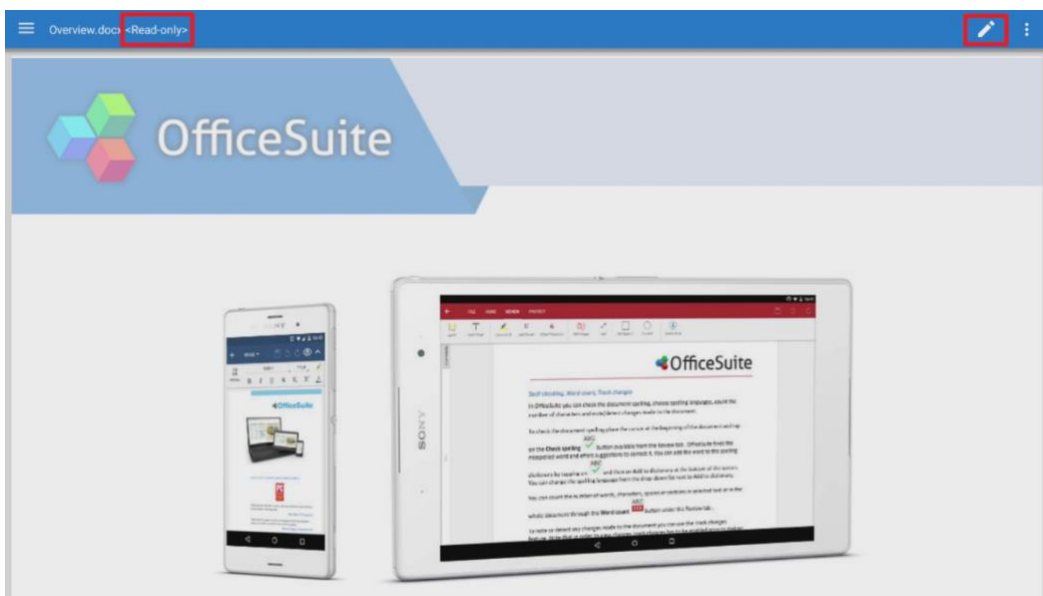

Press “” to save the edit document

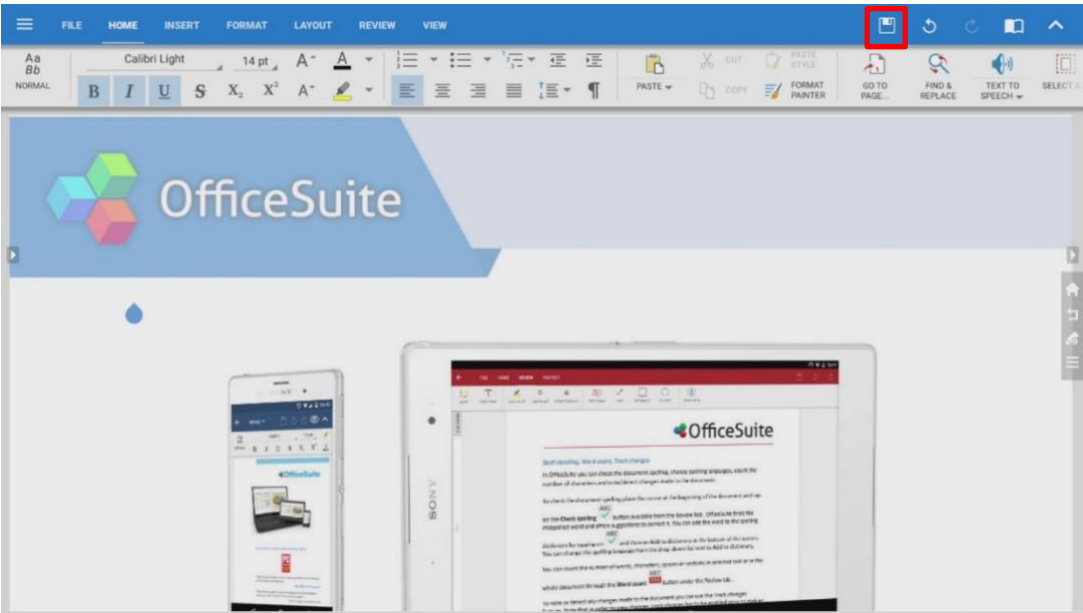

OfficeSuite provide various mode for document

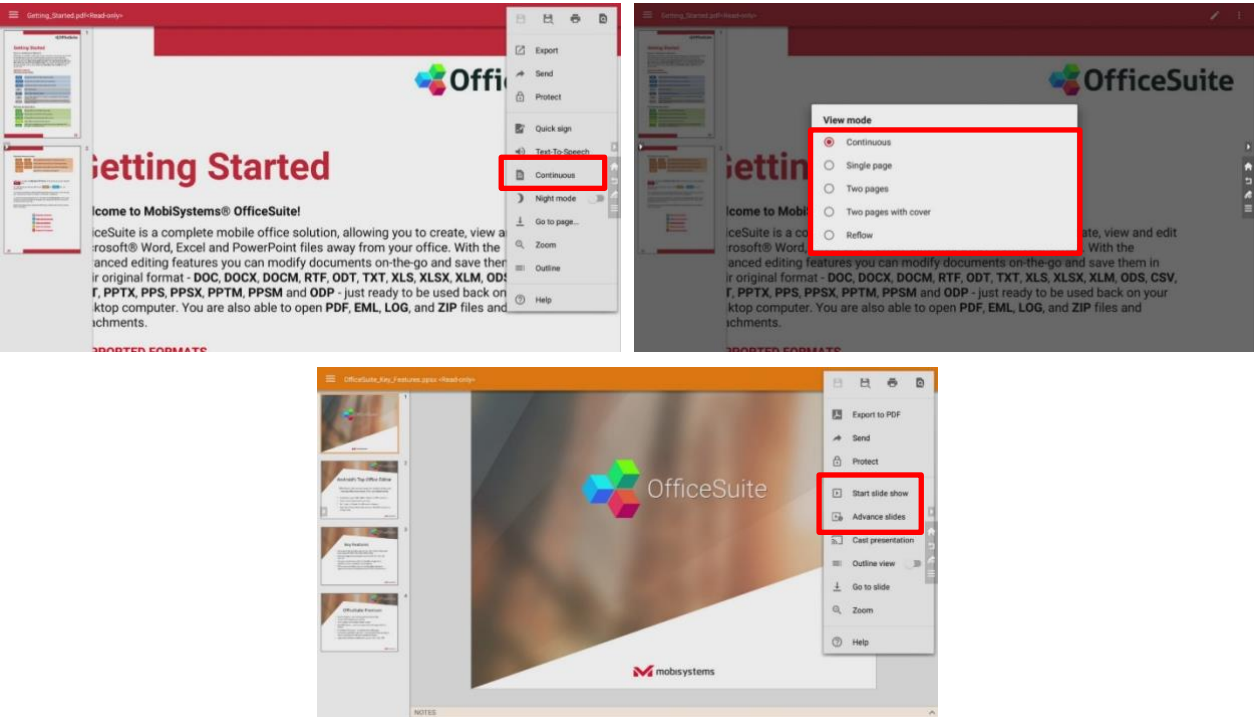

## 5.2.12 Clock

Tap the “” icon to enter “Clock”:

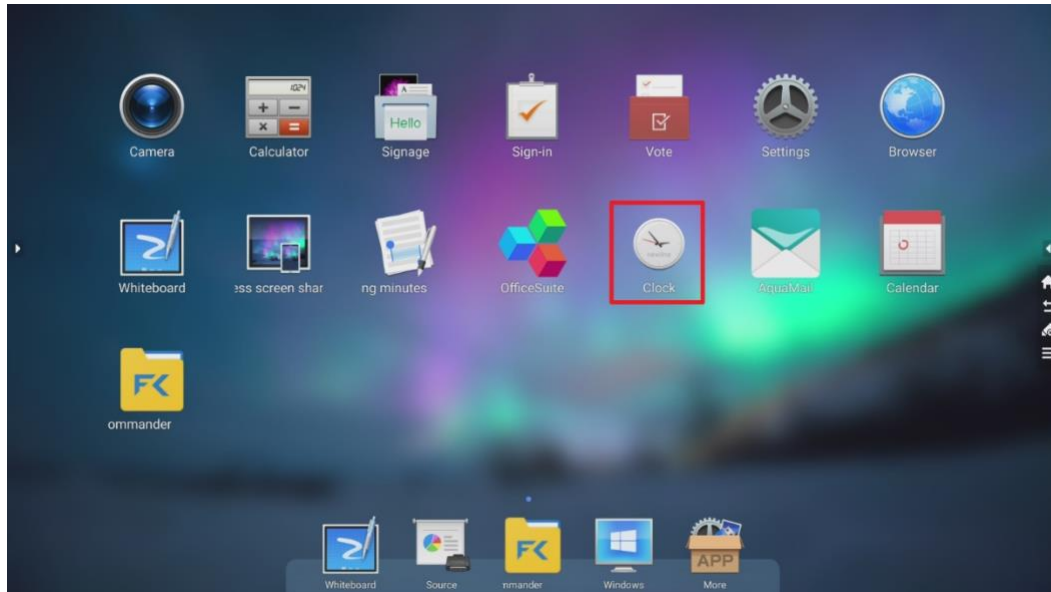

The clock allows user to set alarm (DeskClock), use stopwatch and count down.

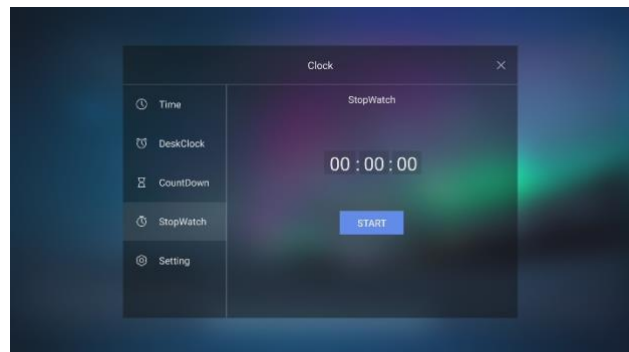
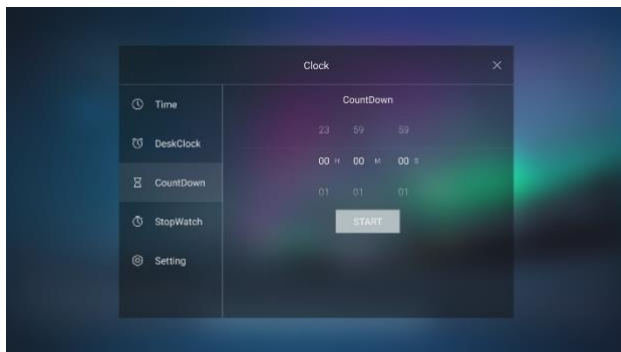
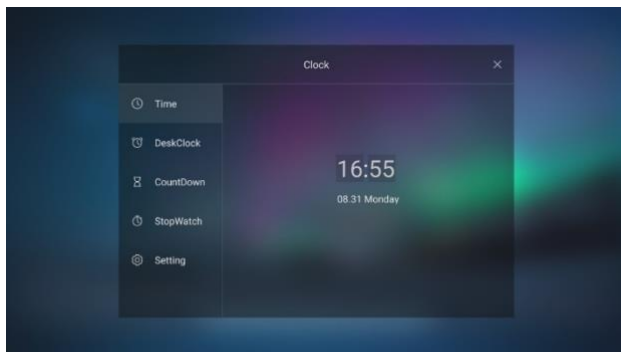

## 5.2.13 Aquamail

Tap the “  ” icon to enter “**Aquamail**”:

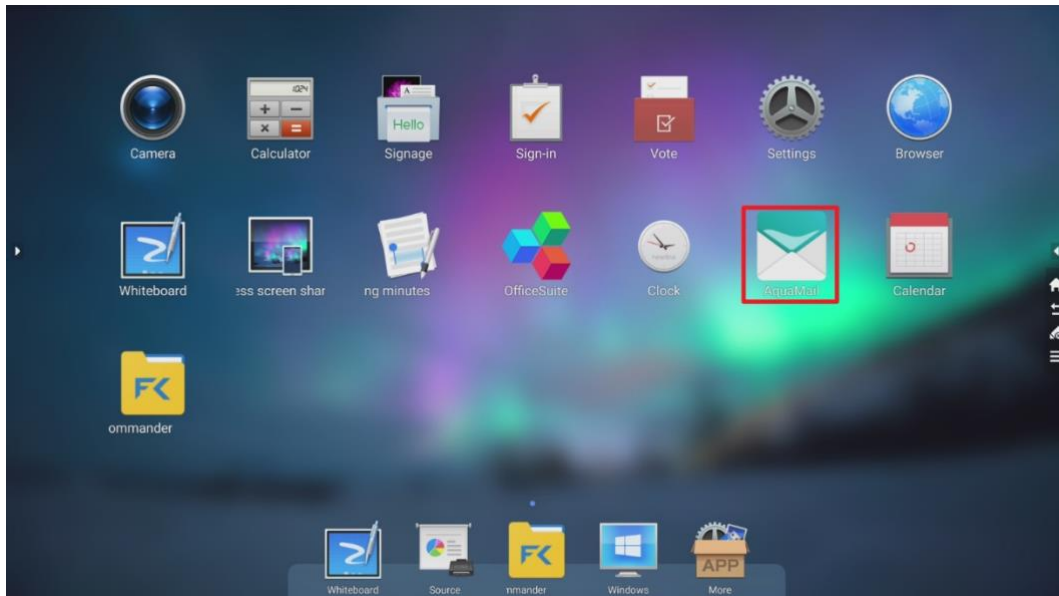

 **NOTE**

*“Aquamail” app only works when the machine are connected to the internet.*

Aquamail gives users the convenience to access their emails on the machine. Simply follow the instruction when connecting Aquamail to the target email service.

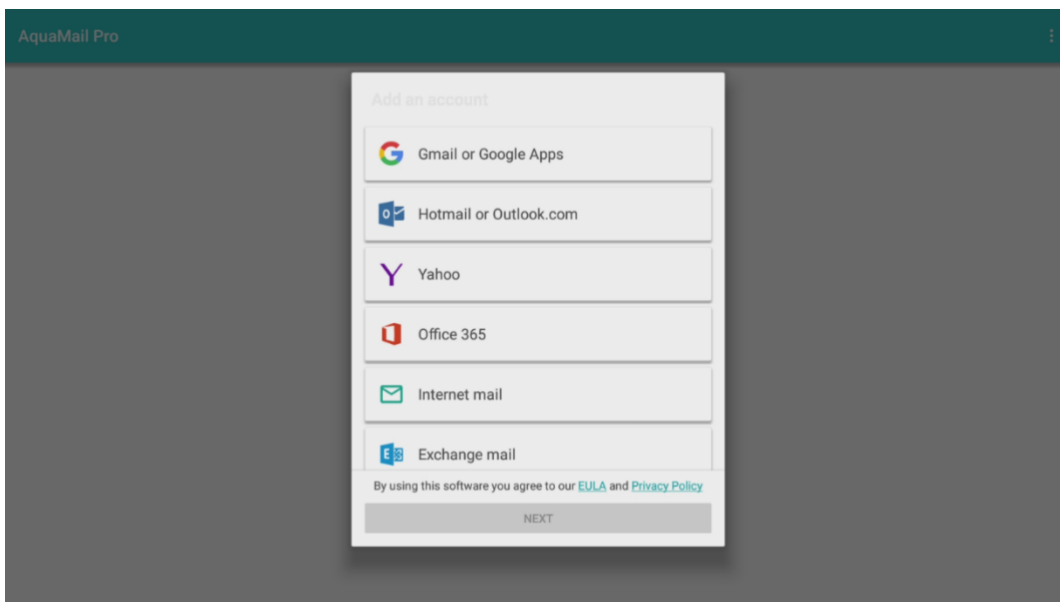



## 5.2.14 Calendar

Tap the “” icon to enter “**Calendar**”:

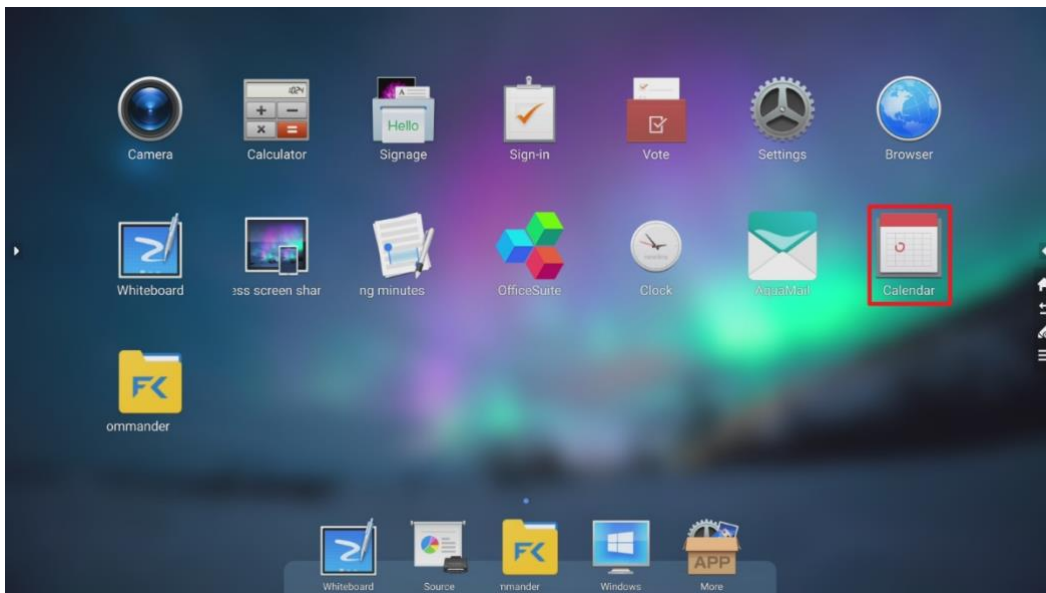

Press “**Start**” to start using Calendar

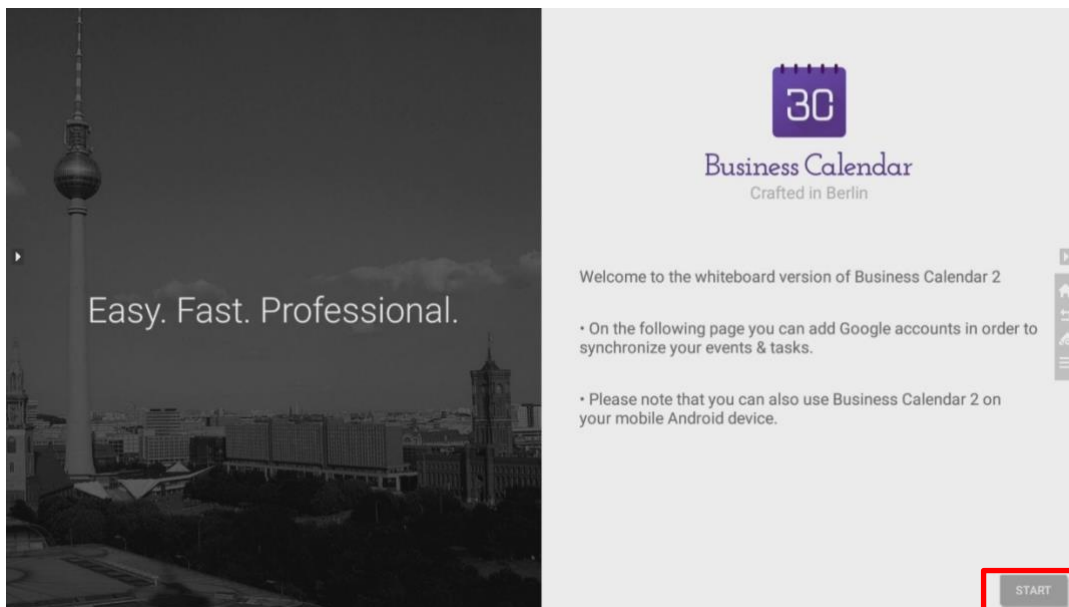

Users can add events on the calendar, and set reminders on the event.

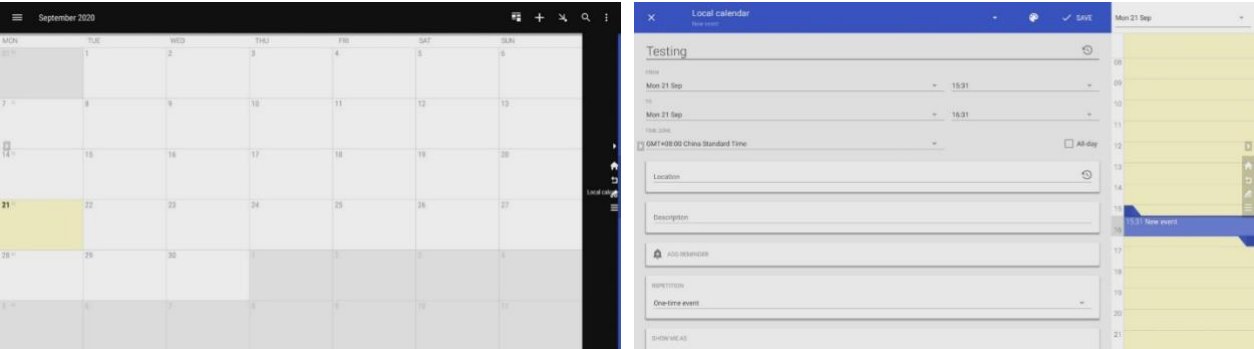

Reminder notification will pop-up on any page

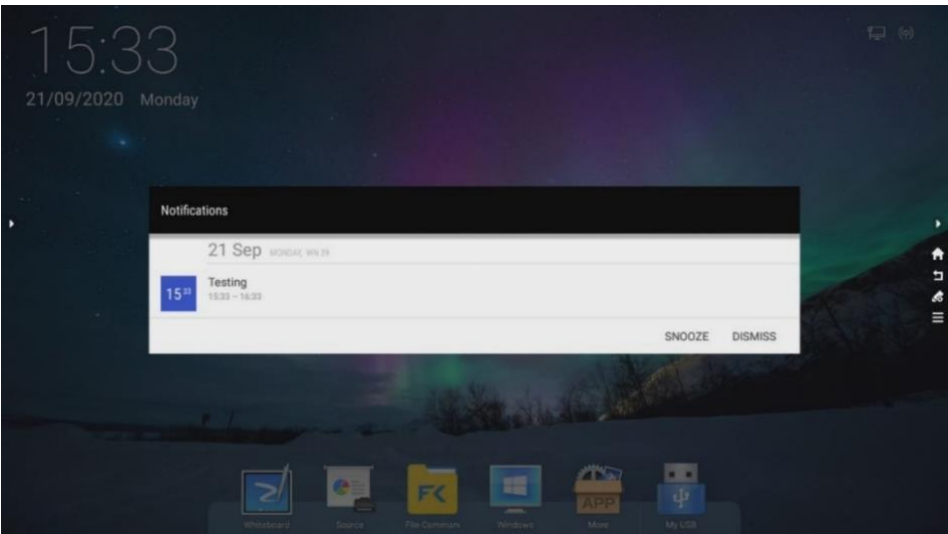

### 5.2.15 File Commander

Tap the "FK" icon to enter the "File Commander". For more detail, please refer to section 5.1.3.



### 5.3 Task Management Sidebar Tool – Default Application

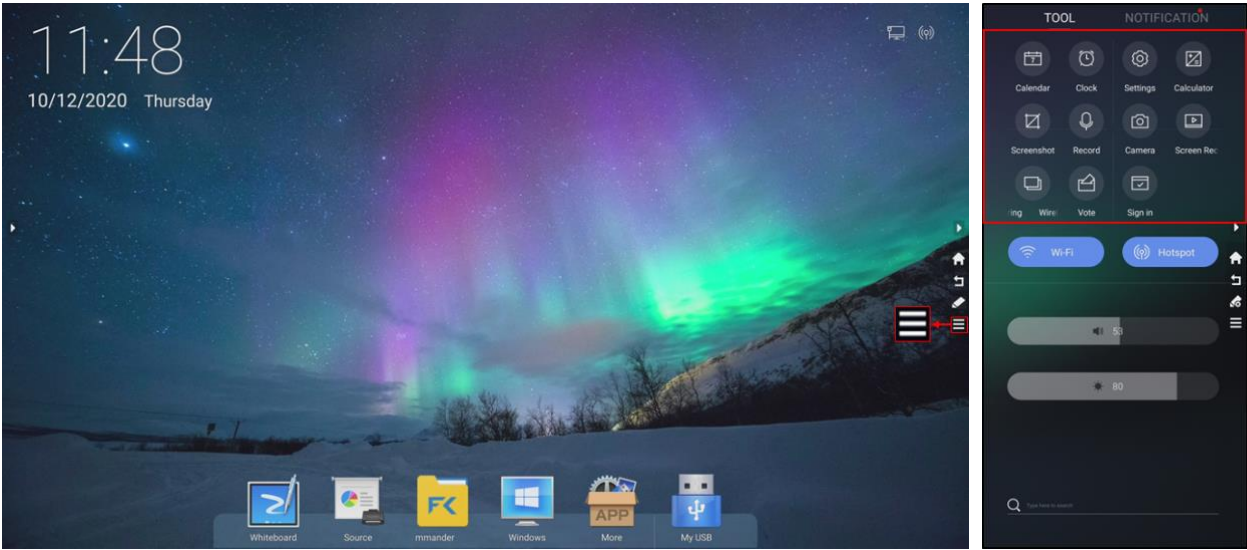

Tap the “☰” icon in the floating bar to enter the task management sidebar, which app shortcut for quick access:

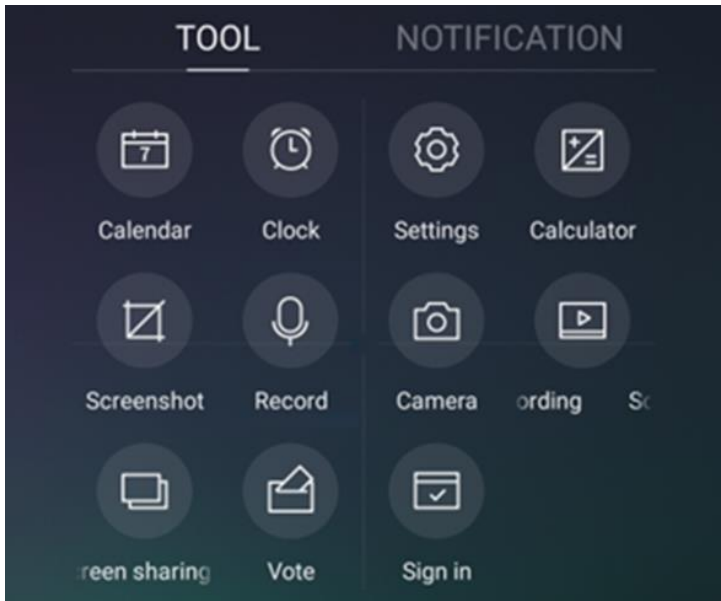

**NOTE**

- “Screenshot”, “Record”, “Screen Recording” can only access by the Task management sidebar tool.
- “Screenshot” application can also be activated by “Screen Capture” on the remote control.



Buttons	Functions
	<b>Calendar:</b> Details at <a href="#">section 5.2.14</a>
	<b>Clock:</b> Details at <a href="#">section 5.2.12</a>

Buttons	Functions
	<b>Settings:</b> Details at <a href="#">section 5.4</a>
	<b>Calculator:</b> Details at <a href="#">section 5.2.2</a>
	<b>Screenshot:</b> Details at <a href="#">section 5.3.1</a>
	<b>Record:</b> Voice recording, details at <a href="#">section 5.3.2</a>
	<b>Camera:</b> Details at <a href="#">section 5.2.1</a>
	<b>Screen Recording:</b> Details at <a href="#">section 5.3.3</a>
	<b>Wireless Screen Sharing:</b> Details at <a href="#">section 5.1.2.2</a>
	<b>Vote:</b> Details at <a href="#">section 5.2.5</a>
	<b>Sign in:</b> Details at <a href="#">section 5.2.4</a>

### 5.3.1 Screenshot

Users can enter “Screenshot” through the following methods:

- Tap the “Screenshot” icon in the task management sidebar;

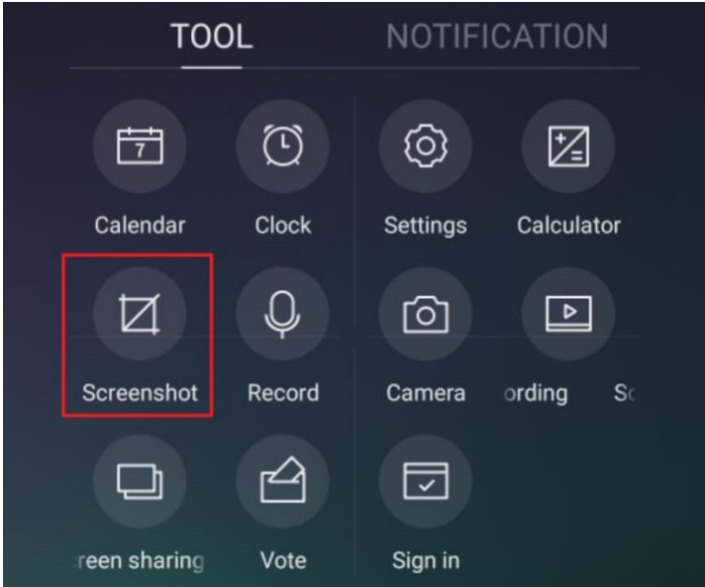

- Press the “Screen Capture” button on the remote control.





After entering the screenshot mode, press and hold the bright box interface with your finger to move on the screen, and the bright box will follow your finger to the position where you need to take the screen. Use your finger to press the bright border inward or outward to narrow or enlarge the screenshot range.



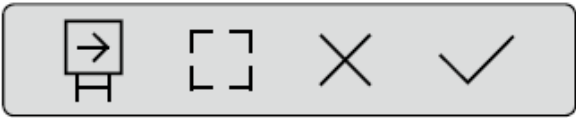

□ Screenshot Menu



Tap the “” icon on the screenshot menu to insert the current screenshot into the whiteboard.

Tap the “” icon to select full screen.

Tap the “” icon to exit the screenshot.

Tap the “” to screenshot the current selected area.

 **NOTE**

Screenshot will be saved in: File Commander -> Pictures -> Screenshots -> Image

### 5.3.2 Record (Voice Recording)

Users can tap the “**Record**” icon in the task management sidebar

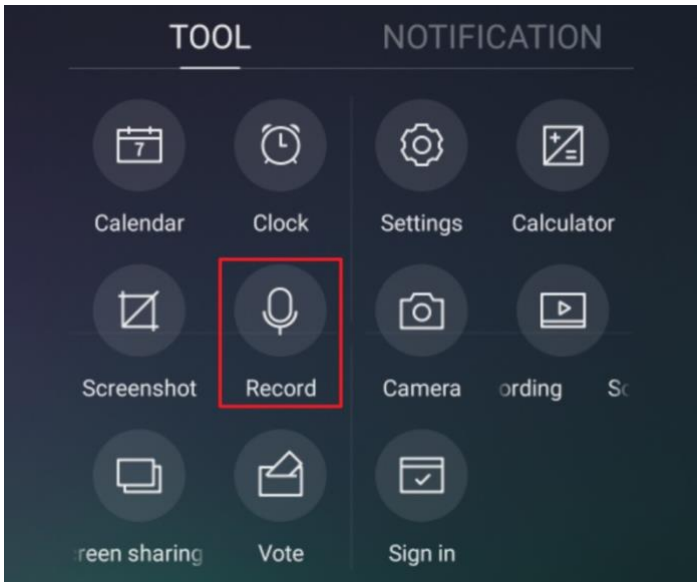

Record the voice via the built-in microphone array. Voice meeting minutes made ease.

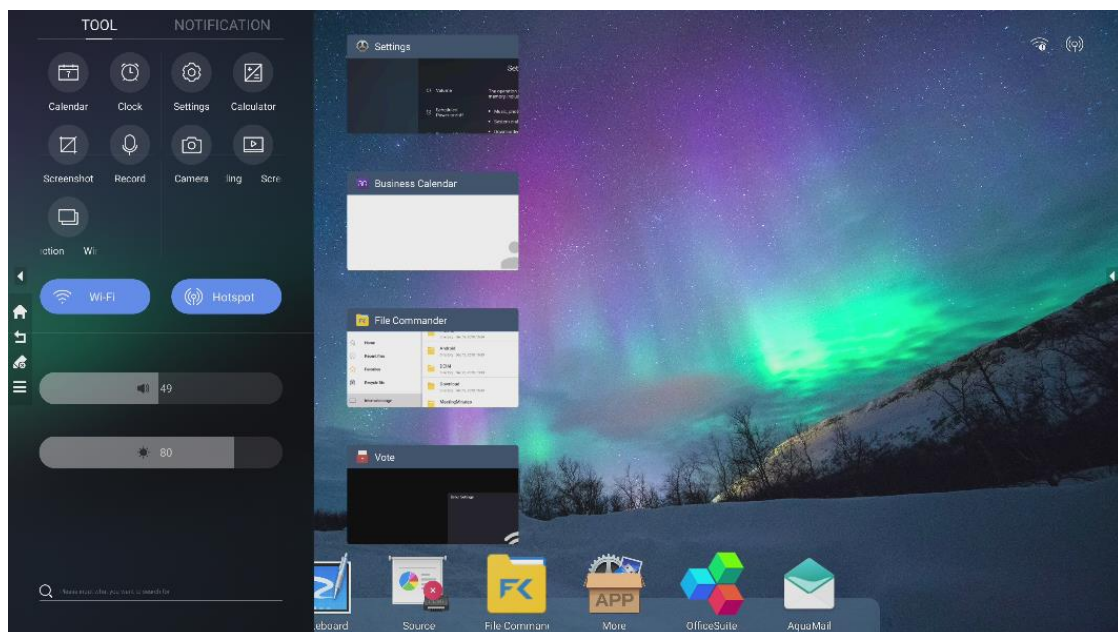
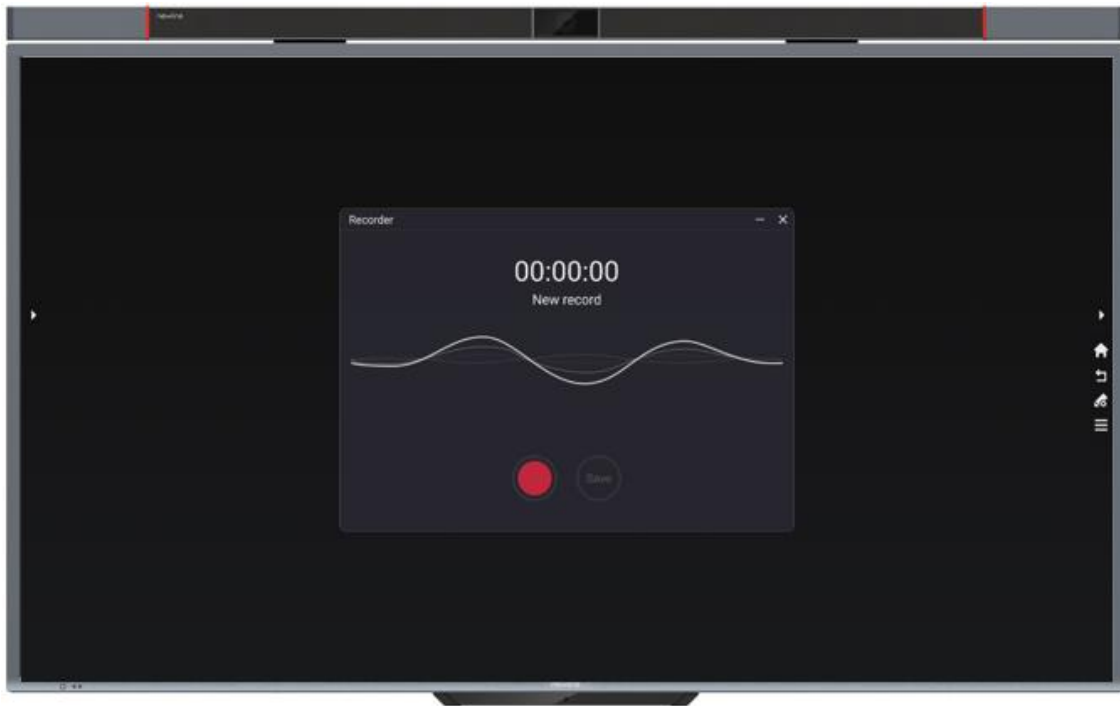

**NOTE**

- When the bottom toolbar is closed, the toolbar will not be displayed at the bottom but on the side toolbar. The user can set it via "Settings > Display > Close the bottom toolbar".
- Record will be saved automatically in "**Meeting Minutes**" (File Commander -> Meeting Minutes)
- Record only works in Android interface

### 5.3.3 Screen Recording

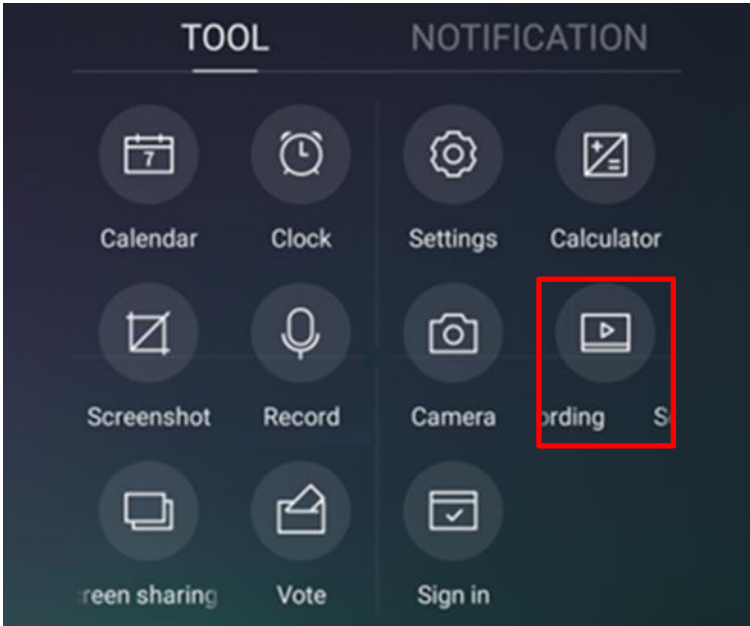

Users can tap the “Screen Recording” icon in the task management sidebar

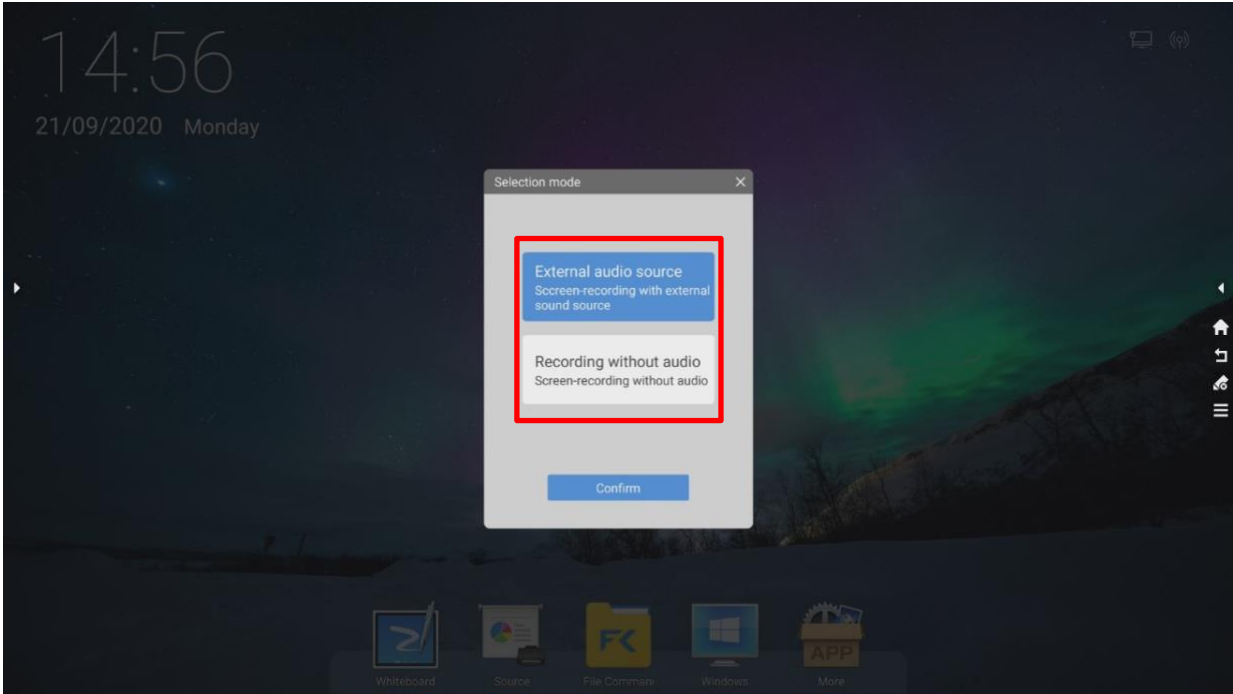

User can choose to screen record with or without external audio (Microphone) sound.





Users can press the  to stop the screen recording, and press  to start another screen recording, press  to exit screen recording.



 **NOTE**

- The recording will be saved in subsequent 45 minutes long sessions. For example: if a recording is 90 minutes long, the record will be separated into two 45 minutes sessions.
- Record will be saved automatically in **“Meeting Minutes”** (File Commander -> Meeting Minutes)
- To Record external sound source while doing screen recording in Windows (OPS), please switch the **“USB Device System Host”** in **“Personal Setting”** to **“Android”**, but the Windows Platform will no longer access to the UCD’s Microphone, Camera and USB port (As below image)

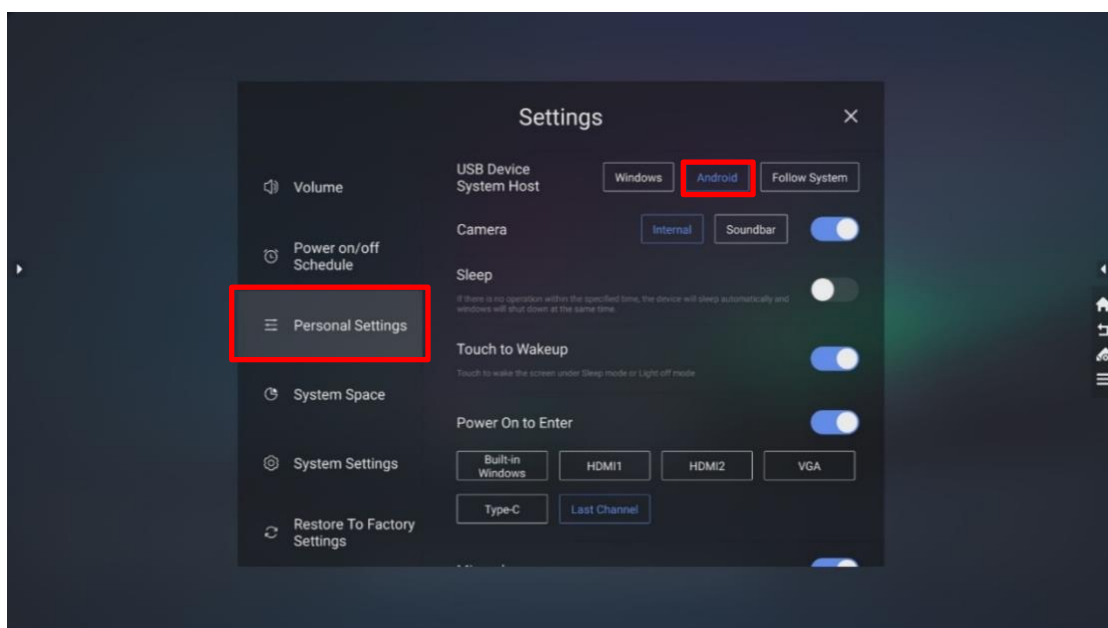

### 5.4 Settings

Tap the “” icon in the “**More**” interface or “**Setting**” in the Task Management sidebar to enter the settings page. The user can set Network, Application Notification, Display, Volume, Scheduled Power-on/off and Personal settings, etc.

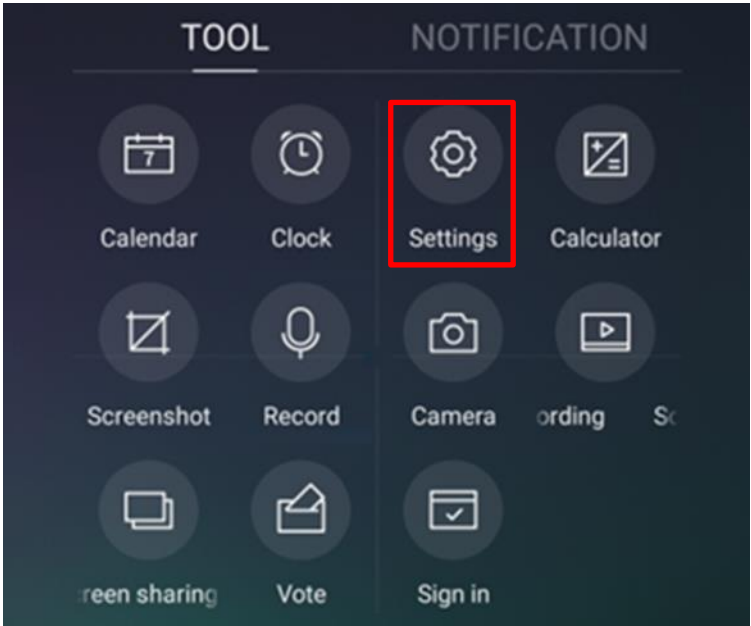
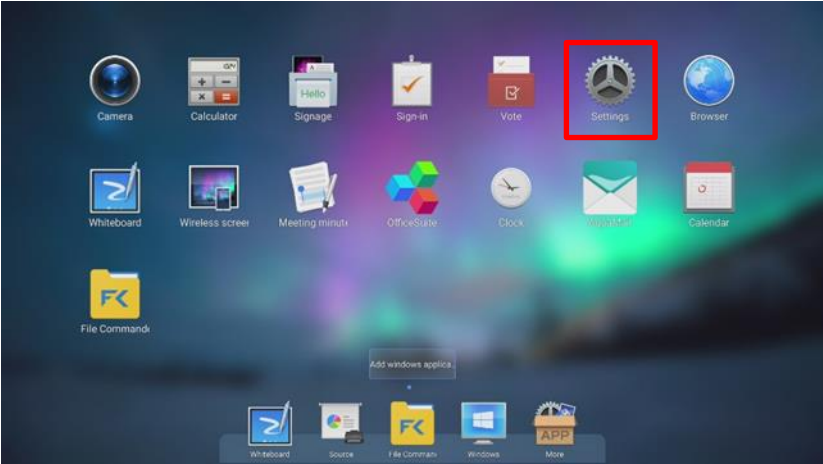

## 5.4.1 Network

Enter the “**Network**” submenu to set settings for Wi-Fi, Ethernet, Hotspot Setting, and Other Settings.

- Wi-Fi: View the MAC address and turn on/off Wi-Fi.
- Ethernet: View the MAC address, IP address, gateway, subnet mask, and DNS information. The user can customize settings to automatically obtain an IP address of the LAN or set a static IP address as needed.
- Hotspot Setting: The user can customize relevant settings for portable Wi-Fi hotspot.
- Other settings: The user can customize settings for network reset, network upgrade, timing reset, network keeps open, and network proxy

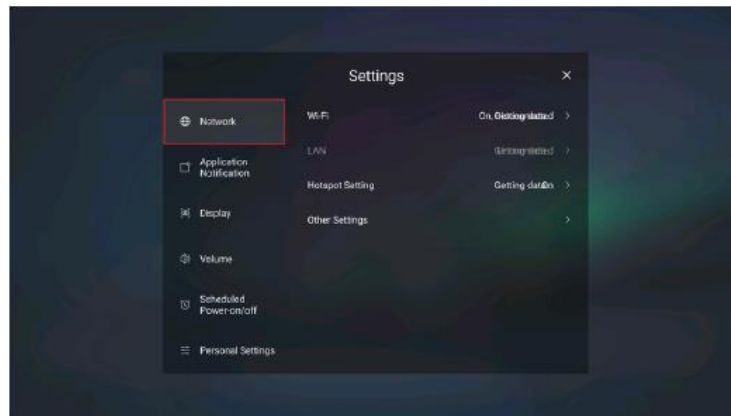

## 5.4.2 Application Notification

Enter the “**Application Notifications**” submenu to set whether the app receives notifications.

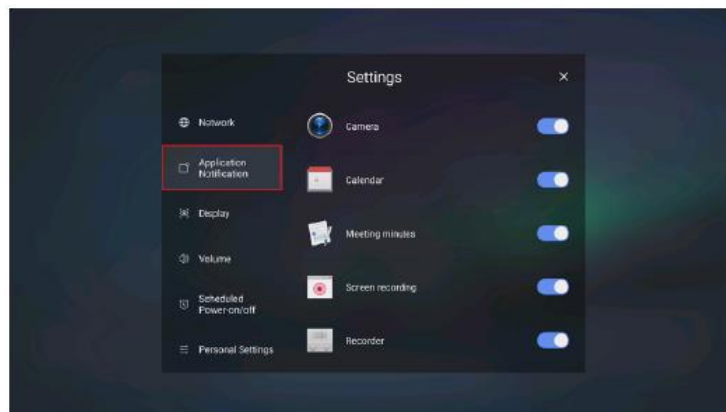

### 5.4.3 Display

Enter the “**Display**” submenu to set the screen backlight brightness, close bottom toolbar.

- Brightness: The user can set the screen to automatically or manually adjust the brightness between 0-100.
- Close the bottom toolbar: When this function is turned on, the bottom toolbar icons will be displayed in the sidebar.
- Blue-lighter filter: The user can set the Software Blue-light filter and adjust the blue-light ratio between 0-100.

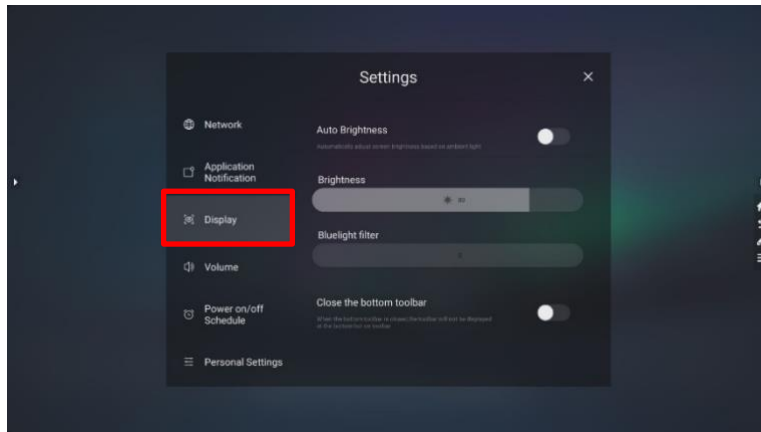

### 5.4.4 Volume

Enter the “**Volume**” submenu to set the media and alarm volume.

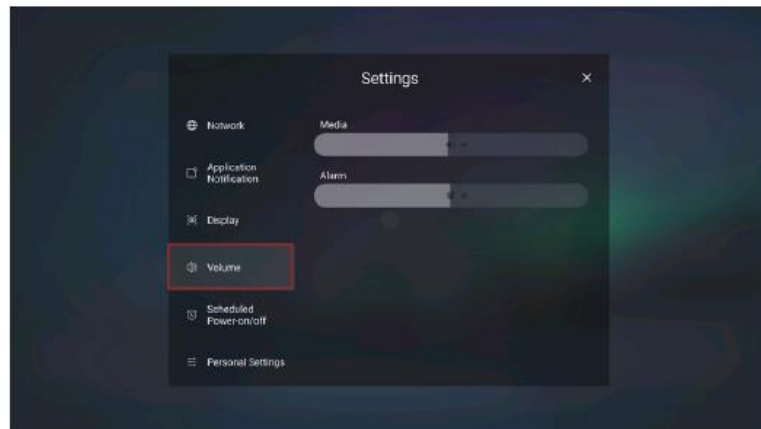

## 5.4.5 Scheduled Power-on/off

The “**Scheduled Power-On/Off**” submenu allows the user to set the automatic power on/off, or customize power on/off time.

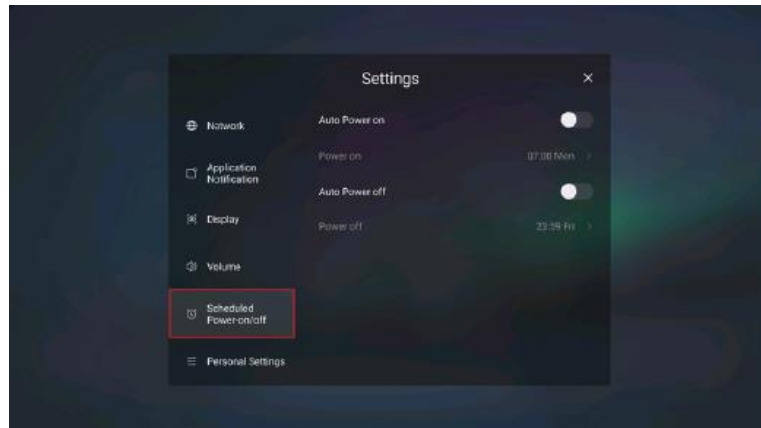

## 5.4.6 Personal Settings

The “**Personal Settings**” menu allows the user to customize USB device system host, camera, microphone, and touch for wakeup, etc. settings.

- **USB Device System Host:** To Control the equipment on the UCD (Camera, Microphone, USB Ports) to pair with which system, options include Windows, Android, and Follow the system.
- **Camera:** Turn the camera on/off; supports in-built and external camera at the soundbar. User can switch between “**Internal**” (Bottom Camera) and “**Soundbar**” (Top camera)
- **Sleep:** Turns on/off sleep mode. When sleep mode is turned on, the device will automatically enter sleep mode and turn off Windows within the specified time.
- **Touch for Wakeup:** Turn on/off touch wake-up. When this function is turned on, the user can touch the screen to wake up the device.
- **Power On to Enter:** Customize settings to enter which platform after power on. The options are HDMI1, HDMI2, VGA, Type C, and the Last channel.
- **Microphone:** Turns on/off the microphone.
- **HDMI Output Mode:** Setting for HDMI output, options is Auto; 2K 60HZ; 4K 30HZ; 4K 60HZ.
- **HDMI Version:** Setting for HDMI version, option are HDMI v1.4 and HDMI v2.0
- **CEC Auto Power On:** When “**CEC Auto Power On**” is enabled: When the HDMI port of the machine is connected to a CEC device (such as a DVD), and both the CEC device and the machine are turned off, if the CEC device is turned on, the machine automatically turns on after receiving the command from the CEC.
- **CEC Auto Power Off:** When “**CEC Auto Power Off**” is enabled: When the HDMI port of the machine is connected to a CEC device, and both the CEC device and the machine are turned on, if the machine is turned off, the CEC device automatically turns off after receiving the command; if the CEC device is turned off, the machine automatically turns off after receiving the command.
- **Automatically clear meeting data after reboot:** Once activated, the meeting data in “**Meeting Minutes**” will be clear after shutdown the UCD

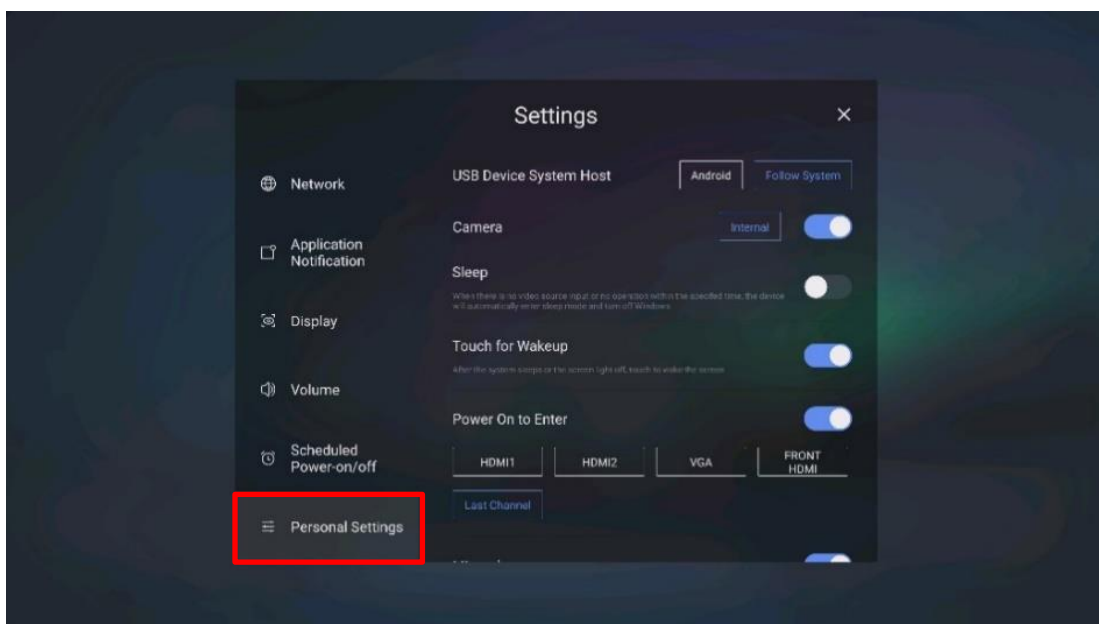

## 5.4.7 System Space

The “**System Space**” submenu allows the user to view the memory capacity and storage space distribution.

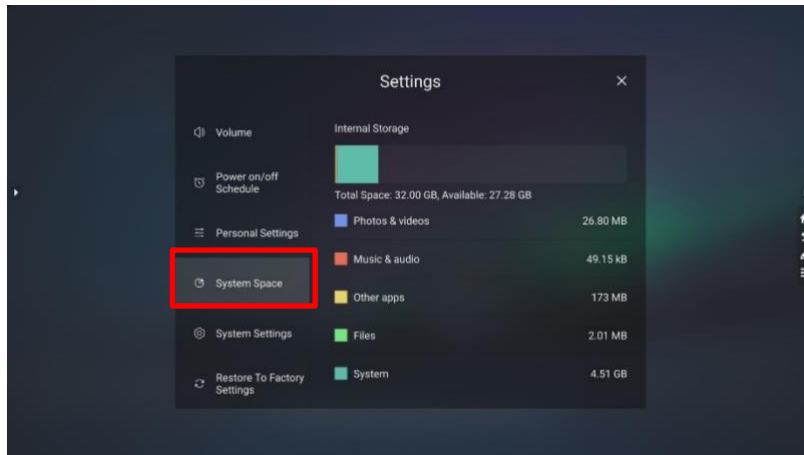

## 5.4.8 System Settings

The “**System Settings**” submenu allows the user to view device information and set time, date, language, and input method.

- About the Device: Update System (firmware), View device name (customizable), Android version, and firmware version.
- Date and Time: The user can customize the device to automatically get the Internet date and time, customize the date and time, and choose whether to enable the 24-hour format.
- Language and Keyboard: The user can set their preferred language and input method. The language options include Simplified Chinese, Traditional Chinese, English, Thai, and Korean.

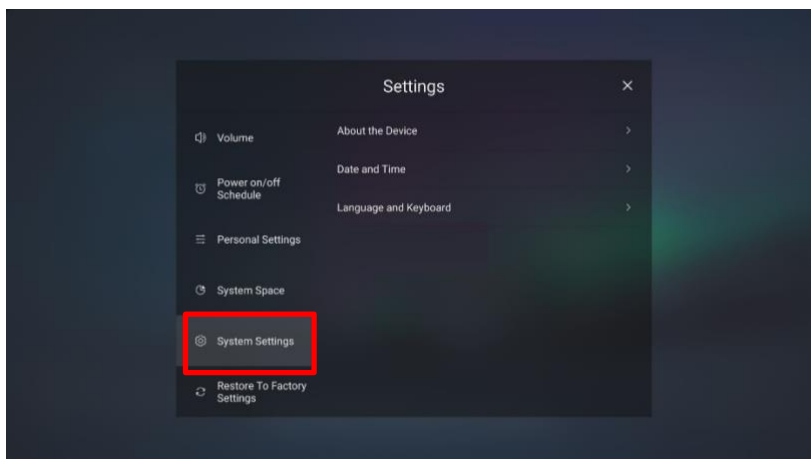

## 5.4.9 Restore Factory Settings

The “**Restore Factory Settings**” submenu allows the user to restore factory settings.

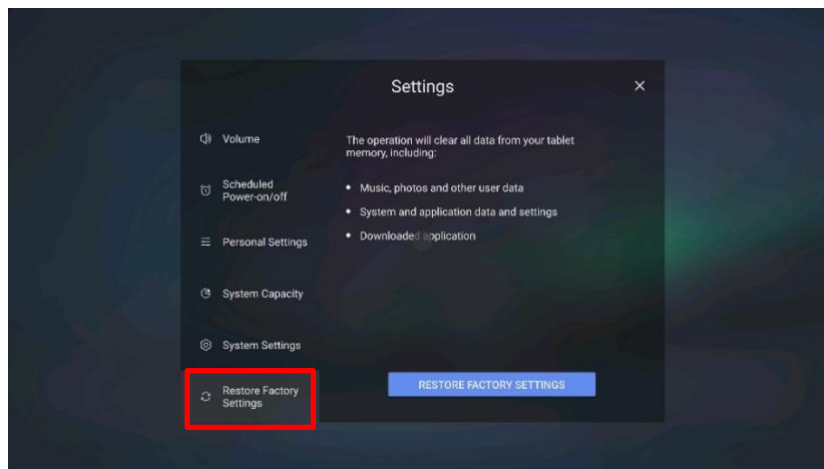

### NOTE

*Restore factory settings will erase all data within the device.*



# 6 Serial Port Control

RS232 communication cable (please use cross data cables)

PIN	This Device	Computer
1	NC	NC
2	RXD0	TXD0
3	TXD0	RXD0
4	NC	NC
5	GND	GND
6	NC	NC
7	NC	NC
8	NC	NC
9	NC	NC
Cover	GND	GND

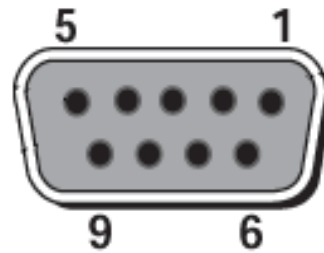

Connect the RS-232 port to a computer or central control device, turn on the RS-232 serial port connection, and customize settings as follows

Port No.: COM1 (set according to the port number of the computer or the central control device)			
Bit rate	115200	Parity check	None
Data bit	8	Stop bit	1

The button control code is assigned as follows: (TV issues the return code to the serial port after receiving the serial port command, and returns to the host computer)

Function	Control Code	Return Code
Turn-On	7F 08 99 A2 B3 C4 02 FF 01 00 CF	7F 09 99 A2 B3 C4 02 FF 01 00 01 CF 00
Turn-Off	7F 08 99 A2 B3 C4 02 FF 01 01 CF	7F 09 99 A2 B3 C4 02 FF 01 01 01 CF
Mute	7F 08 99 A2 B3 C4 02 FF 01 02 CF	7F 09 99 A2 B3 C4 02 FF 01 02 01 CF
HDMI1 (HDMI Rear)	7F 08 99 A2 B3 C4 02 FF 01 0A CF	7F 09 99 A2 B3 C4 02 FF 01 0A 01 CF
HDMI2 (HDMI Rear)	7F 08 99 A2 B3 C4 02 FF 01 0B CF	7F 09 99 A2 B3 C4 02 FF 01 0B 01 CF
OPS (HDMI3)	7F 08 99 A2 B3 C4 02 FF 01 0C CF	7F 09 99 A2 B3 C4 02 FF 01 0C 01 CF
HDMI4 (HDMI Front)	7F 08 99 A2 B3 C4 02 FF 01 38 CF	7F 09 99 A2 B3 C4 02 FF 01 38 01 CF
Computer VGA	7F 08 99 A2 B3 C4 02 FF 01 0D CF	7F 09 99 A2 B3 C4 02 FF 01 0D 01 CF
Listen alone	7F 08 99 A2 B3 C4 02 FF 01 15 CF	7F 09 99 A2 B3 C4 02 FF 01 15 01 CF
Back (exit)	7F 08 99 A2 B3 C4 02 FF 01 1D CF	7F 09 99 A2 B3 C4 02 FF 01 1D 01 CF
Homepage	7F 08 99 A2 B3 C4 02 FF 01 1C CF	7F 09 99 A2 B3 C4 02 FF 01 1C 01 CF
Vol-	7F 08 99 A2 B3 C4 02 FF 01 17 CF	7F 09 99 A2 B3 C4 02 FF 01 17 01 CF
Vol+	7F 08 99 A2 B3 C4 02 FF 01 18 CF	7F 09 99 A2 B3 C4 02 FF 01 18 01 CF
Switch to child lock status	7F 08 99 A2 B3 C4 02 FF 01 57 CF	7F 09 99 A2 B3 C4 02 FF 01 57 01 CF
Get child lock status	7F 08 99 A2 B3 C4 02 FF 01 58 CF	7F 09 99 A2 B3 C4 02 FF 01 58 XX CF
Set system to standby	7F 08 99 A2 B3 C4 02 FF 01 90 CF	7F 09 99 A2 B3 C4 02 FF 01 90 XX CF

## 7

## Signal Input Specifications

## 7.1 VGA Signal Input Specifications

VGA (Video Graphics Array) is a computer display standard for analog signals. The VGA port is a dedicated VGA standard computer data output port. The table below lists the specifications of VGA signal input.

No.	Standard	Resolution	Refresh rate (Hz)
1	VGA	720 x 400	70Hz
2	VGA	800 x 600	60Hz (VESA)
3	VGA	800 x 600	72Hz (VESA)
4	VGA	1280 x 1024	75Hz (VESA)
5	VGA	1280 x 1024	60Hz
6	VGA	1920 x 1080	60.00Hz (recommended)
7	VGA	1360 x 768	60.02 Hz

## 7.2 HDMI/OPS Signal Input Specifications

- (1) HDMI CTS Ver2.0 1.4B standard specifications
- (2) EDID: newline
- (3) HDCP: Ver. 1.1 ; 1.3 ; 2.2
- (4) RECEPTACLE: Type-A connector
- (5) TMDS: Single Link
- (6) Video pixel encoding: RGB 4:4:4, Y/Cb/Cr 4:4:4, Y/Cb/Cr 4:2:2
- (7) VGA/HDMI IN common standard display TIMING

<b>V811 HDMI Timing :</b>	
<b>HDMI-PC Mode</b>	
3840x2160 @ 60Hz (Recommendation)	
1920x1080 @ 60Hz	
800 x 600 @ 60Hz	
1280 x 1024 @60Hz	
1024 x 768 @60Hz	
Monitor Name:	newline
<b>HDMI-Video Mode</b>	
1920 x 1080 I 59.94/60Hz 16:9 ( Not support )	
1280 x 720 P 59.94/60Hz 16:9 Native Mode	
720 x 480 P 59.94/60Hz 16:9	
640 x 480 P 59.94/60Hz 4:3	
1280 x 720 P 50Hz 16:9	
1920 x 1080 I 50Hz 16:9(Not support)	
720(1440) x 576 I 50Hz 16:9 ( Not support )	
1920 x 1080 P 50Hz 16:9	
720 x 480 P 59.94/60Hz 4:3	
720 x 576 P 50Hz 4:3	
720(1440) x 576 I 50Hz 4:3 ( Not support )	
720x480p 60Hz	

### 7.3 HDMI outputs TIMING that can be supported

HDMI-OUT (EDID2.0/HDCP2.2)	1080P	1920*1080	60HZ
	4K	3840*2160	30HZ 60HZ

### 7.4 Type-C Port

It does not support functions such as a type-c USB portable disk. It is a special interface for Soundbar.

# 8

## Formats Supported by Multi-media

---

Multimedia type	Format
Photo	JPEG、PNG、BMP、GIF
Video	MPEG1、MPEG2、MPEG4、H.263、H264、H265、AVS、AVS+、AVS2.0、VC1、Motion JPEG、VP6、VP8、VP9
Audio	MPEG、AAC、VORBIS、PCM、MID、FLAC、DRA、APE

# 9 Troubleshooting

Before contacting a service technician, please conduct an inspection according to the following table. If the problem can't be solved by following the suggested steps, please contact your local dealer. For your safety, do not repair the machine on your own.

Issue	Solution
The machine can't be properly turned on / the indicator is off	<ul style="list-style-type: none"> <li>□ Check whether the power socket is connected to the power source.</li> <li>□ Check whether the power plug is properly plugged in.</li> <li>□ Check whether the power line is in poor condition.</li> <li>□ Check whether the rocker switch has been turned on.</li> </ul>
Automatically turn on/off when unused	<ul style="list-style-type: none"> <li>□ Turn off the automatic power on/off function.</li> <li>□ Check whether the device has been idle for a significant period and therefore the machine has entered sleep mode.</li> <li>□ Check whether the input power is stable.</li> </ul>
No image display	<ul style="list-style-type: none"> <li>□ Check whether the power cord is connected to an electrical outlet and whether the power is turned on.</li> <li>□ Check whether the rocker switch of the machine has been turned on.</li> <li>□ Check whether the power is turned on.</li> <li>□ Check whether the input computer is correctly connected.</li> <li>□ Check whether the input source is correct.</li> </ul>
The image is normal, but there is no sound	<ul style="list-style-type: none"> <li>□ Check the volume.</li> <li>□ Check whether the mute button on the remote control has been pressed.</li> <li>□ Check whether the mute function in the menu is turned on.</li> </ul>
Image or sound is disturbed	<ul style="list-style-type: none"> <li>□ Find interfering electrical equipment nearby and move it away from the machine.</li> <li>□ Do not share the same power outlet with interfering electrical equipment.</li> </ul>
Remote control failure	<ul style="list-style-type: none"> <li>□ Replace the battery.</li> <li>□ Clean the transmission port at the top of the remote control (check whether it is blocked).</li> <li>□ Check whether the batteries are poorly installed.</li> </ul>

Issue	Solution
Image color is abnormal	<ul style="list-style-type: none"> <li>□ Check whether the HDMI cable is connected properly.</li> <li>□ Check whether the VGA cable is connected properly.</li> </ul>
There is no touch control under external source channel	<ul style="list-style-type: none"> <li>□ Try switching between different external sources.</li> <li>□ Make sure that the USB cable is connected to the correct interface. For details, see the “Connecting Panel” section.</li> <li>□ Re-plug the USB cable.</li> </ul>
Built-in computer has no signal	<ul style="list-style-type: none"> <li>□ Check whether the built-in computer is properly inserted into the slot.</li> <li>□ Check whether the built-in computer is in sleep mode.</li> <li>□ Press the power button on the built-in computer (refer to the built-in computer manual for details) and turn it on manually.</li> </ul>
Built-in computer can't be turned on	<ul style="list-style-type: none"> <li>□ Check whether the computer and the machine are properly connected.</li> <li>□ Replace the built-in computer.</li> </ul>
Pen shakes (jitters) when writing	<p>The use of a stylus is recommended. Hold the stylus far away from the tip and keep the angle between the stylus and the screen surface greater than 60° (keep your sleeve or wrist away from the screen surface).</p>
	<p>Remove sources of interference or change to an environment without interference.</p>
Strokes are intermittent when writing (only certain part allows writing)	<p>The use of a stylus is recommended. Hold the stylus far away from the tip and keep the angle between the stylus and the screen surface greater than 60° (keep your sleeve or wrist away from the screen surface).</p>
	<p>Replace the tip or write with a larger occlusion area.</p>
	<p>Check whether there is any foreign object on the infrared strip.</p>
	<p>Remove sources of interference or change to an environment without interference.</p>
Unable to write	<p>Replace with a different colored pen.</p>
	<p>The use of a stylus is recommended. Hold the stylus far away from the tip and keep the angle between the stylus and the screen surface greater than 60° (keep your sleeve or wrist away from the screen surface).</p>
	<p>Remove sources of interference or change to an environment without interference.</p>
	<p>The use of a stylus is recommended. Hold the stylus far away from the tip and keep the angle between the stylus and the screen surface greater than 60° (keep your sleeve or wrist away from the screen surface).</p>

**The following conditions are not failures:**

- Since the LCD panels require precise production technology, there may be very few pixels that are bright or dark, such as tiny red, blue and green spots (bright spots) on the screen, or dark spots on some screens. This isn't a malfunction and will not affect the overall performance of the machine.
- The machine will make a slight noise due to backlight adjustment or heat dissipation. This phenomenon is normal.
- When the projected image and audio sounds are normal, static energy may be felt by touching the LCD screen and the metal back cover.



# 10 Maintenance

---

**Daily Maintenance: To keep the machine in good condition.**

- Do not install or place the machine near a heat source, or place it in direct sunlight, in a dusty or humid environment, or where there is mechanical vibration or shock. To ensure performance, keep it away from high voltage, transmission grid, large metal objects, radar stations, and other equipment.
- Do not wipe the body with chemical agents, as the chemicals may cause the cover to deteriorate or cause damage to the surface paint. If there is dust or dirt, turn off the power and wipe it with a soft cloth. Wipe the touch screen gently with a clean soft cloth.
- Do not switch the machine on and off frequently, as this will affect the machine's service life. After a normal shutdown, please wait at least three minutes before turning it back on. If it is not to be used for a long period of time, please turn off the power and unplug the power cord.
- Do not set the brightness and contrast to the maximum value for extended periods of time as this affects the service life of the LCD screen.
- Do not write on the touch screen with any hard object in order to avoid scratching.

# 11

## Technical Parameter

Specification	Parameter		
Model	TT-6519PTC	TT-7519PTC	TT-8619PTC
Display			
Backlight Type	LED		
Aspect Ratio	16:9		
Physical Resolution	3840 x 2160 Pixel		
Degree of color	8 Bit + FRC	8 Bit + FRC	10 Bit
Soundbar			
Location	Front		
Power Dissipation	50W		
Camera			
Location	Front		
Resolution	3840x2160 Pixel (Top); 1920x1080 Pixel (Bottom)		
Touch			
Material of Touch Surface	Tempered glass		
Touch Sensing Technology	Capacitance		
Touch Points	20 points		
Writing Points	Thick pen 8mm; Fine pen 5mm		
Writing Instrument	Pens, Finger		
Power Dissipation / Transportation / Storage			
Stand-by Power Consumption	≤0.5W		
Working Voltage	100V ~ 240V, 50Hz/60Hz		
Storage Temperature/Humidity	-10°C ~45°C / 20% ~ 90%RH (Non coagulation)		
Working Temperature/Humidity	0 °C ~ 40 °C/ 20% ~ 80% RH (Non coagulation)		
Installation Method	Wall-mount or Mobile Stand		
Rated Power	≤ 300W	≤ 400W	≤ 450W

Specification	Parameter		
Model	TT-6519PTC	TT-7519PTC	TT-8619PTC
Rated Current	Max 3A	Max 4A	Max 4.5A
Display Area length×width (mm)	1428.48×803.52mm	1650.24×928.26 mm	1895.04×1065.96 mm
Boundary Dimension (length × width × the thickness of the bare / With hanging) (mm)	1509*865*86mm/98mm /104mm	1731*1010*86mm/109mm/ 121mm	1977*1150*86mm/109mm /121mm
Package Size	1640*221*1036 mm	1859*247*1160 mm	2119*275*1281 mm
Net Weight	40KG	50Kg	61Kg
Gross Weight	49KG	69Kg	83Kg
<b>Other Functions</b>			
Internal Wi-Fi	2.4G/5G (Support for WIFI and hotspot co-existence)		
<b>Android System</b>			
RAM	4 GB		
Flash	32 GB		
Multimedia file format	Supports most popular multimedia file formats		
<b>Android Software</b>			
The Android Version	8.0.0		
Function	Support screen annotation, whiteboard, wireless screen, Sign-in, vote, and other functions.		

For more machine information, please visit:  
<https://newline-interactive.com/apac/technical-support/>

The company is committed to machine updates and technical improvements. The technical parameters and specifications are subject to change without prior notice. The pictures in this manual are for reference only.

29306-TUNL-001080