

C ***SERIES***

Interactive Flat Panel Display
User Manual

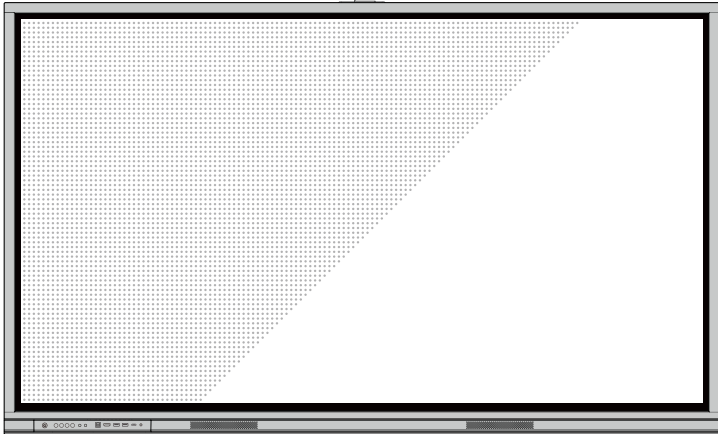

newline

Please properly keep the manual for further reference.

Contents

.....

Contents	01
Symbol Conventions	04
Safety Instruction	05
1.Parts and Functions	09
1.1 Parts.....	09
1.2 Buttons.....	10
1.3 Ports.....	11
1.4 Remote Control.....	14
2.Installation Guide	15
2.1 Safety Precautions.....	15
2.2 Installation Precautions.....	15
2.3 Installation.....	17
2.4 Installing the OPS (Optional).....	18
3.Power On/Off	19
3.1 Power On.....	19
3.2 Power Off.....	19
3.3 Calibration.....	20
4.Source	23
5 Status	24
6 Configuration	25
7 Settings	26
8 ECO Mode	28
9 Serial Port Control	29
10 FAQ&Troubleshooting	33
11 Maintenance Tips	35
12 Clean the Infrared Tube	36
13 Technical Parameters	37
14 More Information	39

Welcome:

Thanks for purchasing this product. Please read the instructions carefully before using this product.

This device complies with part 15 of the FCC Rules. Operation is subject to the following two conditions:(1) This device may not cause harmful interference, and (2) this device must accept any interference received, including interference that may cause undesired operation.

NOTE 1: This equipment has been tested and found to comply with the limits for a Class B digital device, pursuant to part 15 of the FCC Rules. These limits are designed to provide reasonable protection against harmful interference in a residential installation. This equipment generates, uses and can radiate radio frequency energy and, if not installed and used in accordance with the instructions, may cause harmful interference to radio communications. However, there is no guarantee that interference will not occur in a particular installation. If this equipment does cause harmful interference to radio or television reception, which can be determined by turning the equipment off and on, the user is encouraged to try to correct the interference by one or more of the following measures:

- Reorient or relocate the receiving antenna.
- Increase the separation between the equipment and receiver.
- Connect the equipment into an outlet on a circuit different from that to which the receiver is connected.
- Consult the dealer or an experienced radio/TV technician for help.

NOTE 2: Any changes or modifications to this unit not expressly approved by the party responsible for compliance could void the user's authority to operate the equipment.

The symbol of the crossed out wheeled bin indicates this product should not be placed in municipal waste. Instead, dispose of waste equipment by handing it over to a designated collection point for the recycling of electrical and electronic equipment.



Energy Star Compliance



Signage Displays with Plug-in Module

As an ENERGY STAR Partner, Newline Interactive Inc., has followed the EPA's enhanced Product qualification and certification process to ensure that the products marked with the ENERGY STAR logo are ENERGY STAR qualified per the applicable ENERGY STAR guidelines for energy efficiency. The logo appears on the pen tray near front connections on all ENERGY STAR qualified Signage Displays.

The ENERGY STAR program for Signage Displays was created by EPA to promote energy efficiency and reduce air pollution through more energy-efficient equipment in offices, classrooms and factories. One way that a product achieve this goal is by using a power management feature to reduce power consumption when the product is not in use.

For TT-6523C, TT-7523C and TT-8623C, sleep mode can be initiated in a couple different ways. Users can take the action of pressing the power button on the panel, or a remote command can be sent via RS232. The panel will also go into sleep mode without user action after one hour of inactivity.

TT-6523C, TT-7523C and TT-8623C can exit sleep mode by the user pressing the power button, or by the proximity sensors detecting a user's presence, or through a remote command via RS232. In the event of a proximity detection, the panel will transition from sleep mode to another low power mode, STAND BY.

In the event that brightness settings or power mode settings are changed by the user, energy consumption of the panel may increase beyond the limits required for ENERGY STAR certification.

Additional information on the ENERGY STAR program and its environmental benefits are available on the EPA ENERGY STAR Power Management website at <http://www.energystar.gov/powermanagement>.

Additional information on the ENERGY STAR program and its environment benefits are available on the EPA ENERGY STAR website at <http://www.energystar.gov>



For production, above information will need to be available for the Energy Star V8 build from 27th January 2020.

Manufacturer-reported maximum luminance LMax Reported is 400cd/m².

Symbol Conventions





.....

Symbols are used in this document to indicate operations that need particular attention. The symbols are defined as follows:

 NOTE	Provides additional information to supplement operation in the main text.
 CAUTION	Indicates a potentially hazardous situation that, if not avoided, could result in equipment damage, data loss, performance deterioration, or unanticipated results.
 WARNING	Indicates a hazard with risk that, if not avoided, could result in death or injury.

Safety Instruction

For your safety, please read the following instruction before you use the product. Serious injury or property damage may be caused by improper operations. Do not try to repair the product on your own.

 WARNING	
	<p>Disconnect the product from the power supply immediately if major failures occur.</p> <p>Major failures include the following:</p> <ul style="list-style-type: none"> • If smoke, a peculiar smell or an abnormal sound is discharged from the product. • No image or sound is displayed, or the image error occurs. <p>In the preceding scenarios, do not continue to use the product. Disconnect power supply immediately and contact professional staff for troubleshooting.</p>
	<p>Do not drop any liquids, metal or anything combustible onto the product.</p> <ul style="list-style-type: none"> • If any liquids or metal are dropped onto or into the product, power off the product and disconnect the power supply. Then contact professional staff for solutions. • Pay attention to children when they are close to the product.
	<p>Put the product on a stable surface.</p> <p>An unstable surface includes, and is not limited to, an inclined plane, a shaky stand, desk or platform, that might cause the product to turnover and be damaged.</p>
	<p>Do not open the panel or change the product on your own.</p> <p>High voltage components are installed in the product. When you open the panel, high voltage, electric shock, or other dangerous situations may occur.</p> <p>If inspection, adjustment, or maintenance is required, contact the local distributor for help.</p>
	<p>Use the provided power supply.</p> <ul style="list-style-type: none"> • To prevent the product from being damaged, do not use any types of power cables other than the one provided with the product. • Use a three-wire socket and ensure that it is properly grounded. • Pull out the power plug from the socket if the product is not used for a long period.
	<p>Clean the power plug regularly.</p> <ul style="list-style-type: none"> • Fire or electric shock may be caused if the product is powered on, while you are cleaning. • Pull out the power plug before cleaning it with a dried cloth.

WARNING



Do not put items on the top of the product.

- Do not put items, such as a container for liquid (a vase, flowerpot, cosmetics or liquid medicine) on the top of the product.
- If any water or liquid is spilled on the product, the product may short circuit cause fire or electric shock.
- Do not walk on or hang any items on the product.



Do not install the product in an improper place.

- Do not install the product in humid places, such as the bathroom, the shower room, near windows, or outdoor environments that experience rain, snow, or other harsh weather. Avoid installation near hot spring vapor. The preceding environments may cause faults in the product or electric shock under extreme conditions.
- Do not put an exposed fire source, such as a lit candle on the product.



Pull out the power supply during thunderstorms.

- Do not touch the product during a lightning storm, you may experience an electric shock.
- Install or place components that supply high enough voltage to cause personal injury out of the reach of children.



Do not touch the power cable with wet hands.

CAUTION



Do not install the product in high temperature environments.

- Do not install the product near a heat source, such as a radiator, a heat reservoir, a stove or other heating products.
- Do not expose the product to direct sunlight, which may cause high temperatures and subsequent faults in the product.



When transporting the product:

- Pack the product for transport or maintenance by using the cartons and cushioning material provided with the product.
- Move the product vertically during transport. The screen or other components are easily broken if the product is moved in an improper way.
- Before you move the product, disconnect all external connections and separate all topple preventing products. Move the product carefully to prevent it from being hit or squeezed, especially the screen, which may cause injury if broken.

CAUTION



Do not cover or block up any vents on the product.

- Any overheated components may cause fire, damage the product, and shorten the service life.
- Do not lay the product down in a way where the venting surface will be covered.
- Do not install the product on carpet or cloth.
- Do not use a cloth such as table cloth to cover the product.

Keep the product away from the radio.

The product complies with the international EMI standard to prevent radio interference. However, interference may still exist and causes noise in the radio. If noise occurs in the radio, try the following solutions.

- Adjust the direction of the radio antenna to avoid the interference from the product.
- Keep the radio away from the product.

If the screen glass is broken or falls off.

- Keep all personnel 10 feet away from the screen to ensure safety.
- Do not perform any installation or disassembly while the screen glass is broken or has fallen off.



Use the battery correctly.

- Galvanic corrosion, electric leakage, and even fire may be caused by improper battery usage.
- It is recommended to use the designated type of battery and install the battery by the correct electrodes (positive and negative).
- Do not install and use a new battery with a used one.
- Take out the battery if the remote control is not used for a long period.
- Do not expose the battery to overheated environments, such as sunlight and or heat sources.
- Dispose of the used battery based on your local regulations.
- Please use the specified type to replace the battery on the main board, rise of fire or explosion if the battery is replaced by an incorrect type.

Do not damage the power cable.

- Do not damage, change, twist, bend, or forcibly drag the power cable.
- Do not put weights (such as the product itself) on the power cable.
- Do not forcibly drag the cable when you pull out the power plug. If the power cable is damaged, please contact the local distributor to repair or replace it.
- The power cable in the accessory box is for this product only. Do not use it on other products.

CAUTION



Additional advice:

- Use the product in an environment with comfortable lighting. It is harmful to your eyes to watch in a too bright or too dark environment.
- Relax your eyes watching for a period of time.
- Keep sufficient distance from the product to protect your eyes and prevent eyestrain.
- Adjust the volume to an appropriate level, especially at night.
- Use amplifier equipment as the audio input source with caution. If you must use amplifier equipment, the input power should not exceed the maximum of speaker power. Otherwise, the speaker can become overpowered and damaged.

About USB port.

USB 3.0 ports switch connections based on signal sources. If the current signal source is reading the data from an external product connecting to the port, please switch the signal source after the data reading is complete. Otherwise, the data or product may be damaged.

1

Parts and Functions

.....

Thank you for choosing Interactive Flat Panel Display. As our latest independently developed and produced human-machine interactive products, Under no signal, if there is no operation, the Interactive Flat Panel Display will automatically shut down. The Interactive Flat Panel Display are multi-functional teaching displays for interactive teaching, digital demonstration, multi-media presentation and touch operations. They are well designed and produced to meet needs of education applications, and provide a user-friendly experience, digital intelligent control as ideal apparatus for modern education.

Features:

- Specially designed for teaching systems.
- Adopt advanced infrared array scanning and sensing technology, HID driver-free, meaning the product is activated soon after it is powered on.
- Multi-signal sources can be switched by touching the screen.
- A special button is set to adjust the brightness with no impact on watching and save up to 50% energy.
- Support high-power amplifiers.
- When the screen display function is disabled, the product can still play audio to save energy.
- High brightness and contrast display to ensure clear display under straight light or in outdoor environment.
- If there is no signal and no operation is performed, the Interactive Flat Panel Display will automatically shut down.

1.1 Parts

- Front View

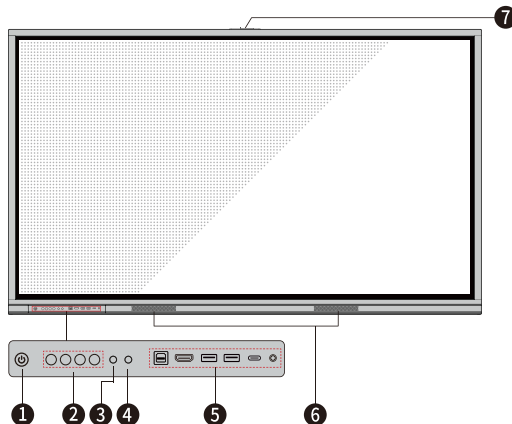

• Rear View

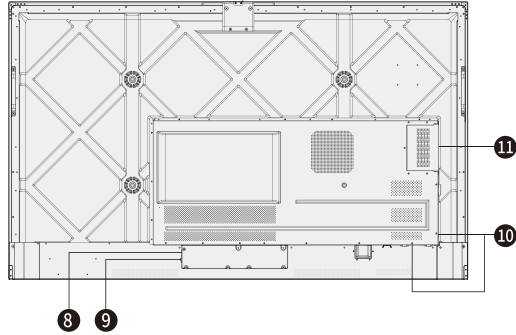

①	Power On/Off	⑦	Camera Port
②	Front Buttons	⑧	Power Supply Inlet
③	Remote Control Receiver	⑨	Power Switch
④	Light Sensor	⑩	Rear Ports
⑤	Front Ports	⑪	OPS Slot
⑥	Speakers		

1.2 Buttons



Buttons	Operations	Functions
⏻	Short press	Power on Solid white color : Display is on and working
		Power off Solid red color : Display is in shut down mode
🔊	Short press	Adjust the Sound Volume
☀️	Short press	Adjust the Brightness
📺	Short press	Enter the Source Selection Page
☰	Short press	Open the Setting menu

1.3 Ports

• Front Ports

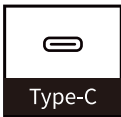
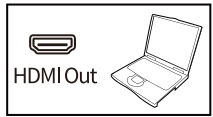
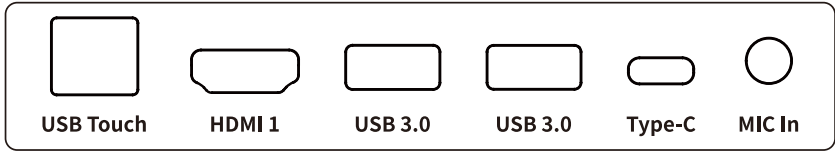

• Rear Ports

 **CAUTION**

- Front USB ports and rear USB 3.0/USB 2.0 ports switch connections based on signal sources. If the current signal source is reading the data from an external product connecting to the port, please switch the signal source after the data reading is complete. Otherwise, the data or product may be damaged.
- For USB use, USB 2.0 provides up to 500mA whereas USB 3.0 provides up to 900mA of power. Please make sure the USB flash drive is formatted to FAT32 before inserting into the panel.
- Please use the supplied cable in the accessory box or the HDMI association certified shielded cable to better ensure the signal quality.
- While HDMI and Display Port offer support for cables of varying lengths, the maximum cable length that the panel recommends for optimal performance is 3 meters (10 feet) for HDMI and 1.8 meters (around 6 feet) for Display Port. Using cable longer than recommended length may cause data loss and a negative impact to display quality.

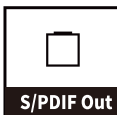
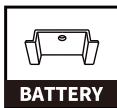
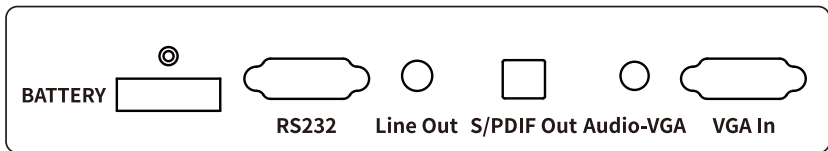

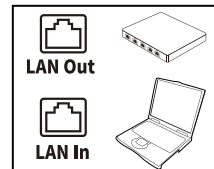
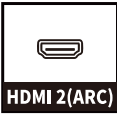
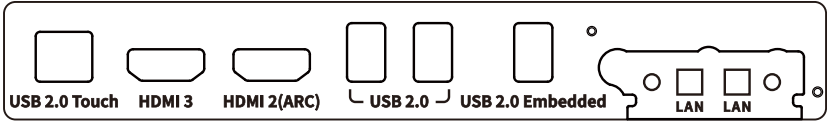













1.4 Remote Control

CAUTION

Carefully read the following instructions before using the remote control to avoid possible faults:

- Do not drop or damage the remote control.
- Do not spill water or other liquids on the remote control.
- Do not place the remote control on a wet object.
- Do not place the remote control directly under sunlight or near a heat source.

Buttons	Operations
	Power On/Off
	Go to the Home Page
	Directional Pad
	Confirm/OK
OPS	Press once to enter the OPS page
	Enter the Source Selection Page
	Return to Previous/Exit
	Press once to increase the brightness, long press to increase the brightness continuously
	Press once to decrease the brightness, long press to decrease the brightness continuously
	<ul style="list-style-type: none"> • Open the Setting menu on the embedded operating system. • Open the menu in Windows system.
	Mute/Unmute Audio
	Press once to increase the volume, long press to increase the volume continuously
	Press once to decrease the volume, long press to decrease the volume continuously



2

Installation Guide

2.1 Safety Precautions

• Installation Environment

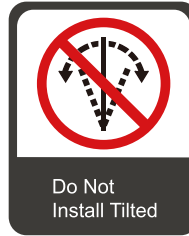

• Installation Direction

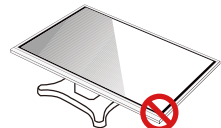
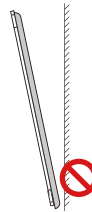
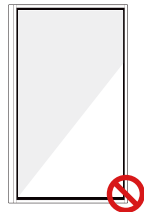

2.2 Installation Precautions

• Weight Loading

- Weight of the panel:
- 65INCH: 84.9lbs / 38.5kg
- 75INCH: 110lbs / 50kg
- 86INCH: 163lbs / 74kg

- When using a mobile stand, ensure that the weight of the panel is less than the loading capacity of the mobile stand.
- When using the wall-mount bracket, ensure that the wall can support the weight of the panel. We recommend that the wall surface be reinforced and have a loading capacity 4 times of the weight of the panel. Consult a professional installer for wall-mount installation.

NOTE

The company does not undertake relevant legal responsibility for any problems caused by improper operation, if the third party mobile stand, or wall-mount bracket is beyond the scope of the panel.

- Do not install the product where it might be hit by an opening or closing door.

• Vertical installation

When installing the panel, try to keep the panel vertical. An excessive tilt angle may cause damage to the glass or other internal components.

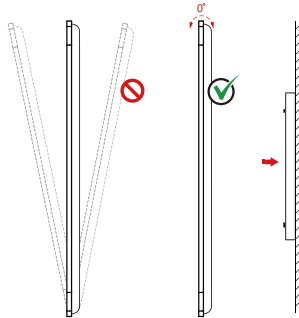

NOTE

For any problem, please contact our support desk. Our company is not responsible for any damage or losses incurred by users if the users fails to follow the instructions.

• Ventilation

Ensure adequate ventilation and/or an air conditioned environment. We recommend keeping certain distances from the side of the panel to the wall or panels. Ventilation requirements are shown in following figure:

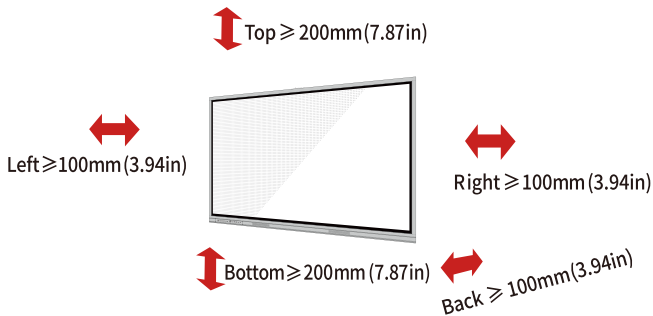

2.3 Installation

The dimensions of the four bracket mounting holes on the back panel are VESA MIS-F compliant. Use metric M8*20 screws in accessory box to secure the machine with the mounting system. Dimensions of the mounting holes on the back panel are shown on the following figure.

- TT-6523C: 600 x 400 mm / 23.62 x 15.75 in;
- TT-7523C/TT-8623C: 800 x 400 mm / 31.50 x 15.75 in;
- Tiny VESA Mount: 75 x 75mm / 2.95 x 2.95 in.

65"

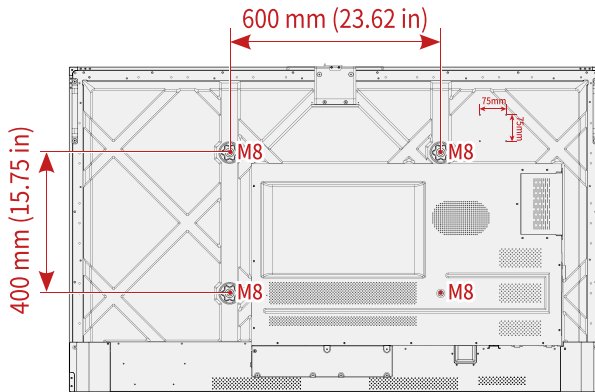

75"/86"

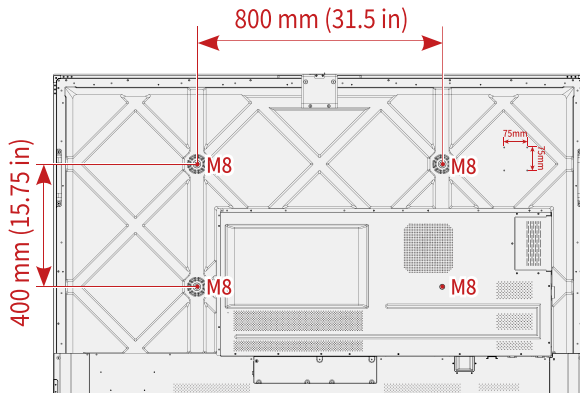

NOTE

Consult a professional installer to install the machine.

2.4 Installing the OPS (Optional)

CAUTION

The OPS does not support hot plugging. Therefore, you must insert or remove the OPS when the display is powered off. Otherwise, the display or OPS may be damaged.

You will need to purchase the OPS separately. Perform the following steps to install the OPS.

Step 1: Unscrew the M4 screws by hand to remove the OPS protective cover.

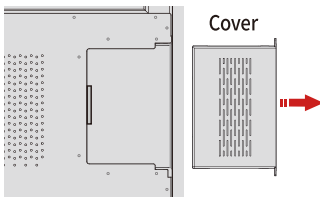

Step 2: Push the OPS into the OPS port on the rear of the panel until firmly seated, using the M4 screws to secure the OPS.

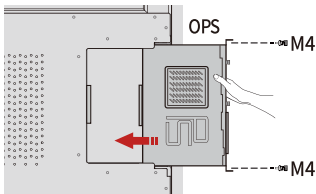

3

Power On/Off

3.1 Power On

Step 1: Ensure the power cable is fully seated into the panel and wall outlet before powering on the panel. Please confirm your wall outlet supports a power range of 100V to 240V with frequency at 50 Hz/60 Hz \pm 5% and is fully grounded.

NOTE

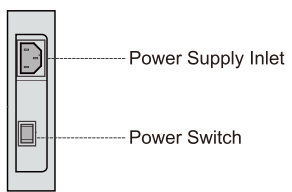

The power outlet should be installed near the equipment and should be easily accessible.

Step 2: Flip the power switch located on the side of the product to "I".



Step 3: Press the power button  on the front control panel or  on the remote control.

3.2 Power Off

Step 1: Press the power button  on the front panel or the power button  on the remote control and a **Warning** dialog box will be displayed as shown in the following figure.

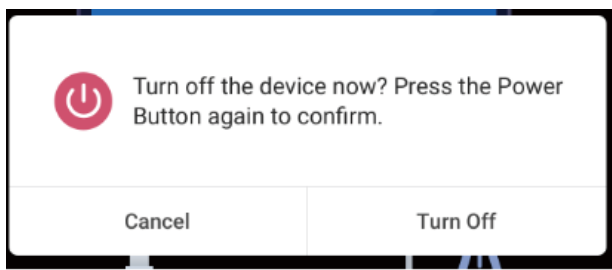

Step 2: In the **Warning** dialog box, tap **Cancel** to return to working mode. Tap **Turn off** to turn off the display, and the power indicator will turn to red.

Step 3: If you are not going to use the display for an extended period of time, we recommend you to switch the power switch to "O".

NOTE

- If an OPS is installed, the OPS and the screen will simultaneously powered off when the power is shutdown.
- Please properly shut down the panel before disconnecting the power source or it may cause damage. Accidental power failure may cause damage to the panel.
- Do not repeatedly turn the power on & off in a short period of time as it may cause malfunction.

3.3 Calibration

If the cursor position has a big deviation from the actual touch point, calibration is used to eliminate the deviation. Positioning is required in the following scenarios:

- The internal PC is used.
- A computer is connected through the HDMI and VGA interface.

NOTE

Interface operation on the Smart system does not need positioning. External products with Microsoft Windows 7 or later versions will require positioning.

If the positioning is not correct, perform the following operations to calibrate again. The following takes Windows 10 as an example:

Step 1: Ensure that the HDMI or VGA interface and external products are connected properly.

Step 2: Select the corresponding Windows signal from the signal source menu. The Windows page will be displayed.

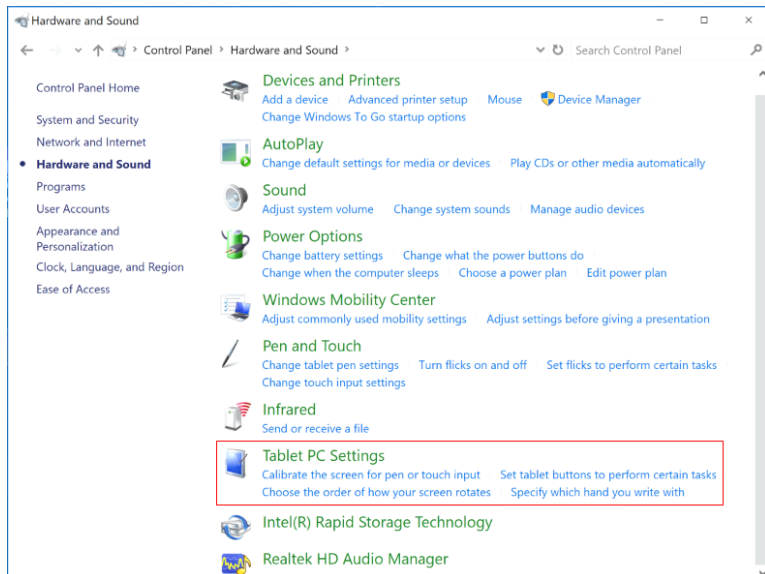

Step 3: Select **Tablet PC Settings** on the **Control Panel** page.

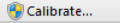

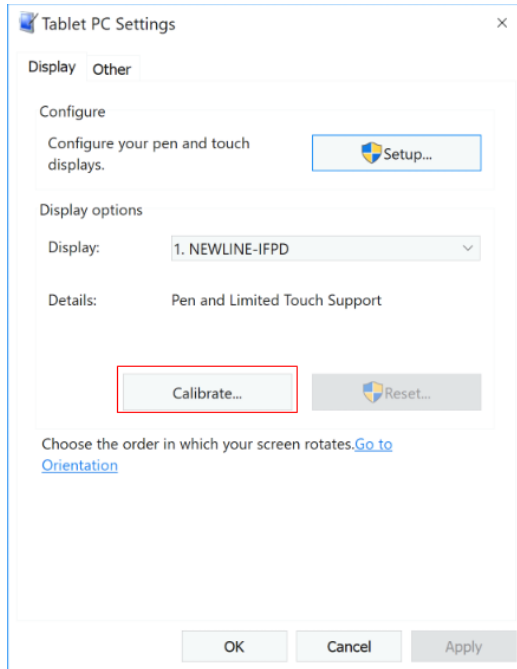
Step 4: Select “  ” in the Tablet PC Settings window.



Step 5: Select **Touch input** from the option and start calibration.

Step 6: Use finger or a pencil to click and hold the center of the flickering cross  . Do not release it until  moves to the next positioning point. Complete the calibration process as instructed.

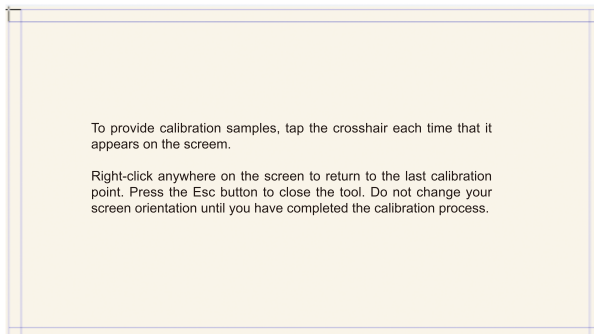

Step 7: After the calibration is complete, the **Digitizer Calibration Tool** dialog box will be displayed. Click **Yes** to save calibration data.

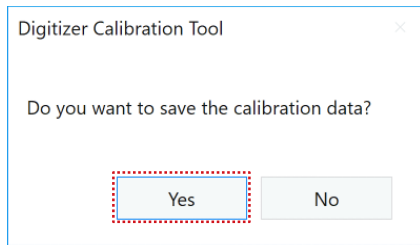

 **TIP**

- To ensure writing accuracy, use the pencil or stylus included with the product for proper positioning.
- Positioning errors may cause failure of touch functions of the display. In that case, please perform calibration again.

Step 8: The **Tablet PC Settings** dialog box will be displayed again. Click **OK**. The positioning will be complete.

4

Source

Enter the Source selection page by the following method:

- Press  on the remote control;
- Swipe two fingers from the bottom of the screen toward the center of the screen.

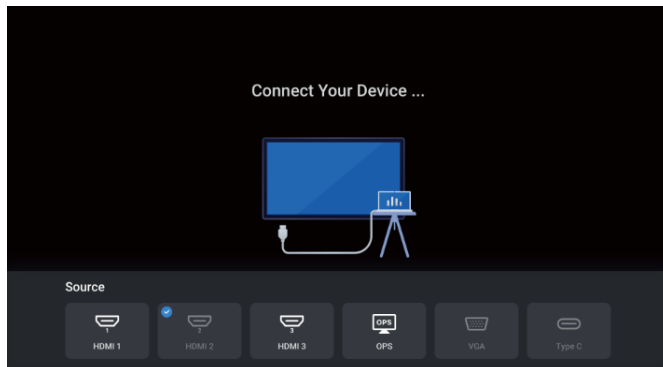

The icon without signal source connected is gray, and the icon with signal source connected is white. Tap any one of the icons to enter the signal source channel.







5

Status

After the Interactive Flat Panel Display is powered on, users can enter the menu page by the following method:

- Press  button on the remote control;
- Press  button on the front panel;
- Swipe two fingers from the left/right edge of the screen toward the center of the screen.

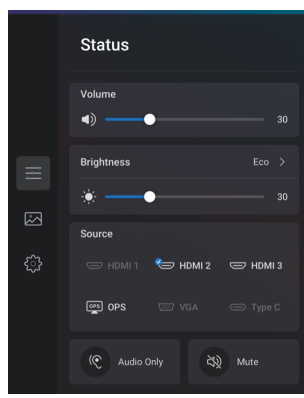

Use your finger to tap the screen or press / / /  on the remote control to select a menu item, press OK to complete the menu switching and option setting. Tap  to back to the previous menu, tap on the outside of the menu to exit the setting.



Menu	Function
Volume	Default is 30, drag the slider to adjust the sound volume.
Brightness	Tap > to select the brightness mode. ECO: 30; Standard: 100; Auto: Five levels of set value, according to the ambient light automatically adjust; Custom: Drag the slider to adjust the brightness respectively.
Source	Tap the icon to select the external signal source (HDMI1, HDMI2, HDMI3, OPS, Type-C and VGA). The icon will light up when the external device connected successful.
Sound Only	Tap to enter the Sound Only, the screen turns black. Tap anywhere on the screen to exit the Sound Only (bright screen).
Mute	Tap to mute the device. After the mute setting, a mute icon will appear in the upper right corner of the screen.

6

Configuration

Tap  to enter configuration interface. The menu items include **Picture** and **Display**. Use your finger to tap the screen or press ◀/▶/▲/▼ on the remote control to select a menu item, press OK to complete the menu switching and option setting. Tap  to back to the previous menu.

Menu	Function
Picture Setting	
Picture mode	Tap > to set the picture mode (Soft > Custom > Vivid > Normal). Only in custom mode, you can drag the slider to adjust the Brightness, Contrast, Saturation or Sharpness respectively.
Color temperature	Tap > to set the Color temperature (Medium >Warm >Cool).
Display Setting	
Aspect Ratio	Tap > to set the aspect ratio the screen display. Options include 16:9, Point-to-point and 4:3.
Color Range	Tap > to set the color range. Options include 0-255, 16-235, and auto.

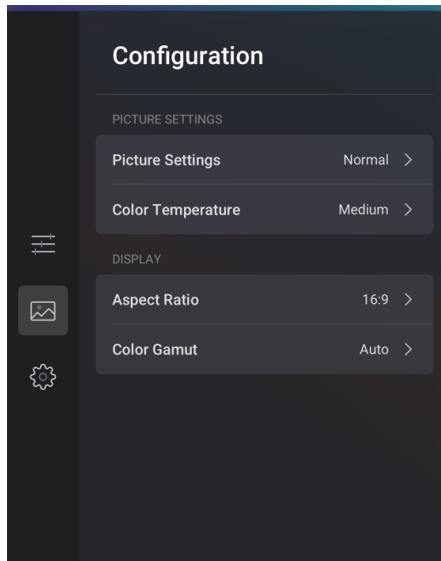

7

Settings

Tap  to enter **Settings** interface.

Use your finger to tap the screen or press ◀/▶/▲/▼ on the remote control to select a menu item, press **OK** to complete the menu switching and option setting. Tap  back to the previous page.

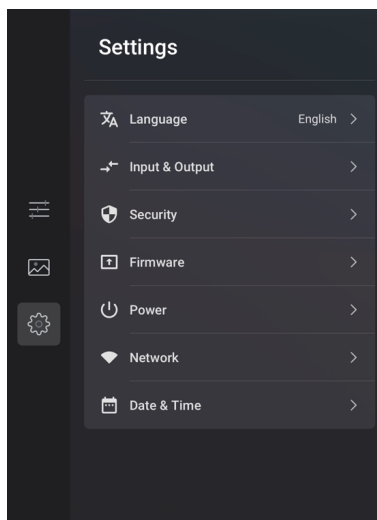

Menu	Function
Language	Tap Language to select the language.
Input / Output	<ul style="list-style-type: none"> • Starting Source: Customize settings to connect to the signal source after power on. Tap > to set the starting source (OPS>Type C >VGA>HDMI 1> HDMI 2> HDMI 3). • Auto Source Switching: Tap to enable or disable auto source switching. System can automatically switch to the screen of the newly connected signal source after the function is enabled. • CEC Auto Power On: “CEC Auto Power On” is enabled, when the HDMI port of the panel is connected to a CEC device (such as a DVD), and both the CEC device and the panel are turned off, if the CEC device is turned on, the panel automatically turns on after receiving command from the CEC. • CEC Auto Power Off: “CEC Auto Power Off” is enabled, when the HDMI port of the panel is connected to a CEC device, and both the CEC device and the panel are turned on, if the panel is turned off, the CEC device automatically turns off after receiving the command; if the CEC device is turned off, the panel automatically turns off after receiving the command.

Menu	Function
Security	<ul style="list-style-type: none"> • USB Port Lock: Tap to enable or disable the function. When you enable the USB lock, USB disk will be locked under the OPS system, user will not able to read the data from the USB disk, but USB mouse and keyboard could be used. Under the external source, all the USB devices will be blocked. • Auto Hide Menu: Tap to enable the function and set the time for auto hide menu.
Firmware	Tap to select OTA Update, view the firmware version and serial number.
Power	<ul style="list-style-type: none"> • Energy saving: Tap > to set a duration when the screen is left un-operated, the screen will automatic power off. The duration can be set to 30min, 60min, 120min, 180min, Never or customize time. • Auto power on: When the function is on, tap to set the date and time for the display auto power on. • Auto power off: When the function is on, tap to set the date and time for the display auto power off. • Signal source wake up: Connecting the external signal source on sleep mode, the screen will wake up and automatically switch to the access to the source. • Wake on Lan: The panel can be waked up by the cable network.
Network	Tap to view the network information, such as IP address and Mac address, change Lan setting.
Date & time	<p>Before setting the date and time, users should tap Time zone to select local time zone.</p> <ul style="list-style-type: none"> • Time Zone: Tap to select the time zone for your region. • Date & time auto settings: Tap to enable or disable the function. • Set date: When Date & time auto settings is off, tap to set the date. • Set time: When Date & time auto settings is off, tap to set the time.

**CAUTION**

- Please switch off the panel when it is not used and enable the function of Audio Only when you do not need to watch the display, which help reduce power consumption and save energy.
- On the premise of ensuring viewing effect, the energy consumption can be reduced by lowering display brightness.
- To better save energy, the Energy Saving function is configured for the Interactive Flat Panel Display. If no operation is performed in a set time, the Interactive Flat Panel Display is switched automatically to power off for reducing energy consumption.

Enter brightness setting on the Status menu, tap > to enter the **ECO** mode(Standard > Auto > Custom > ECO).

- In the **Standard** mode, the screen brightness keeps the same.
- In the **Auto** mode, the display automatically adjusts the screen brightness according to the light in the environment. When the light is strong, the screen brightens. When the light is weak, the screen darkens.
- In the **ECO** mode, the brightness is reduce to 30.
- In the **Custom** mode, you can drag the slider to adjust the brightness as your wish.

9

Serial Port Control

The RS-232 port of the Interactive Flat Panel Display is defined as follows:

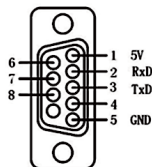

Connect RS-232 port to the PC or controlling device. Enable RS-232 serial port connection and complete the following configuration.

Port: COM1 (Set according to PC or controlling device's port number)			
Baud rate	19200	Odd/even check	None
Data bits	8	Stop bit	1

The following table lists button controlling codes. The buttons share same functions with corresponding buttons on the remote control:

Function	Controlling codes	Return codes
Power on	7F 08 99 A2 B3 C4 02 FF 01 00 CF	7F 09 99 A2 B3 C4 02 FF 01 00 01 CF
Power off	7F 08 99 A2 B3 C4 02 FF 01 01 CF	7F 09 99 A2 B3 C4 02 FF 01 01 01 CF
Mute/Unmute	7F 08 99 A2 B3 C4 02 FF 01 02 CF	7F 09 99 A2 B3 C4 02 FF 01 02 01 CF
Signal source	7F 08 99 A2 B3 C4 02 FF 01 06 CF	7F 09 99 A2 B3 C4 02 FF 01 06 01 CF
HDMI(Front)	7F 08 99 A2 B3 C4 02 FF 01 0A CF	7F 09 99 A2 B3 C4 02 FF 01 0A 01 CF
HDMI(Rear) 1	7F 08 99 A2 B3 C4 02 FF 01 52 CF	7F 09 99 A2 B3 C4 02 FF 01 52 01 CF
HDMI(Rear) 2	7F 08 99 A2 B3 C4 02 FF 01 53 CF	7F 09 99 A2 B3 C4 02 FF 01 53 01 CF
VGA	7F 08 99 A2 B3 C4 02 FF 01 54 CF	7F 09 99 A2 B3 C4 02 FF 01 54 01 CF
OPS	7F 08 99 A2 B3 C4 02 FF 01 38 CF	7F 09 99 A2 B3 C4 02 FF 01 38 01 CF
Type C(Front)	7F 08 99 A2 B3 C4 02 FF 01 51 CF	7F 09 99 A2 B3 C4 02 FF 01 51 01 CF

Function	Controlling codes	Return codes
Volume-	7F 08 99 A2 B3 C4 02 FF 01 17 CF	7F 09 99 A2 B3 C4 02 FF 01 17 01 CF
Volume+	7F 08 99 A2 B3 C4 02 FF 01 18 CF	7F 09 99 A2 B3 C4 02 FF 01 18 01 CF
Menu	7F 08 99 A2 B3 C4 02 FF 01 1B CF	7F 09 99 A2 B3 C4 02 FF 01 1B 01 CF
Home	7F 08 99 A2 B3 C4 02 FF 01 1C CF	7F 09 99 A2 B3 C4 02 FF 01 1C 01 CF
Return	7F 08 99 A2 B3 C4 02 FF 01 1D CF	7F 09 99 A2 B3 C4 02 FF 01 1D 01 CF
OK	7F 08 99 A2 B3 C4 02 FF 01 2B CF	7F 09 99 A2 B3 C4 02 FF 01 2B 01 CF
←	7F 08 99 A2 B3 C4 02 FF 01 2C CF	7F 09 99 A2 B3 C4 02 FF 01 2C 01 CF
→	7F 08 99 A2 B3 C4 02 FF 01 2D CF	7F 09 99 A2 B3 C4 02 FF 01 2D 01 CF
↑	7F 08 99 A2 B3 C4 02 FF 01 2E CF	7F 09 99 A2 B3 C4 02 FF 01 2E 01 CF
↓	7F 08 99 A2 B3 C4 02 FF 01 2F CF	7F 09 99 A2 B3 C4 02 FF 01 2F 01 CF
Adjust volume	7F 08 99 A2 B3 C4 02 FF 05 XX CF	7F 09 99 A2 B3 C4 02 FF 05 XX 01 CF Notes: XX indicates current volume value, range: 0-100 (XX is a hexadecimal value, range: 00~64).
Display firmware version	7F 08 99 A2 B3 C4 02 FF 01 3D CF	7F 09 99 A2 B3 C4 02 FF 01 3D 01 CF
Set the backlight mode	7F 08 99 A2 B3 C4 02 FF 06 XX CF	7F 09 99 A2 B3 C4 02 FF 06 XX 01 CF XX indicates backlight status 00: Standard; 01: ECO; 02: Custom; 03: Auto.

Function	Controlling codes	Return codes
Increase backlight brightness	7F 08 99 A2 B3 C4 02 FF 01 47 CF	7F 09 99 A2 B3 C4 02 FF 01 47 01 CF
Decrease backlight brightness	7F 08 99 A2 B3 C4 02 FF 01 48 CF	7F 09 99 A2 B3 C4 02 FF 01 48 01 CF
Adjust backlight brightness	7F 08 99 A2 B3 C4 02 FF 09 XX CF	7F 09 99 A2 B3 C4 02 FF 09 XX 01 CF Notes: XX indicates backlight brightness, range: 0-100 (XX is a hexadecimal value, range: 00~64).
Turn on/off the backlight	7F 08 99 A2 B3 C4 02 FF 01 15 CF	7F 09 99 A2 B3 C4 02 FF 01 15 XX CF Notes: XX=01 ON; XX=00 OFF.

Function	Querying codes	Return codes
Power supply	7F 08 99 A2 B3 C4 02 FF 01 37 CF	7F 09 99 A2 B3 C4 02 FF 01 37 XX CF Notes: XX indicates the power on/off state. XX = 01: power on state; XX = 00: power off state.
Speaker	7F 08 99 A2 B3 C4 02 FF 01 82 CF	7F 09 99 A2 B3 C4 02 FF 01 82 XX CF Notes: 01: mute; 00: non-mute.
Current signal source	7F 08 99 A2 B3 C4 02 FF 01 50 CF	7F 09 99 A2 B3 C4 02 FF 01 50 XX CF Notes: PC = 17; HDMI rear 1 = 1F; HDMI Rear 2 = 1E; VGA = 20 HDMI 3= 19; Type C = 18.

Function	Querying codes	Return codes
Speaker volume	7F 08 99 A2 B3 C4 02 FF 01 33 CF	7F 09 99 A2 B3 C4 02 FF 01 33 XX CF Notes: XX indicates current volume value (XX is a hexadecimal value, range: 00~64). For example, XX = 20 indicates current volume value is 32 (decimal value), XX = 00 indicates mute state.
D.Mode	7F 08 99 A2 B3 C4 02 FF 01 35 CF	7F 09 99 A2 B3 C4 02 FF 01 35 XX CF Notes: XX indicates the mode. XX = 00-standard; XX = 01-ECO mode; XX = 02-custom; XX = 03-auto.
Picture Settings	7F 08 99 A2 B3 C4 02 FF 01 86 CF	7F 09 99 A2 B3 C4 02 FF 01 86 XX CF Notes: 00: normal; 01: Vivid; 02: Soft; 03: Custom.
Color Temperature	7F 08 99 A2 B3 C4 02 FF 01 87 CF	7F 09 99 A2 B3 C4 02 FF 01 87 XX CF Notes: 00:Medium; 01:Warm;02:Cool
Aspect Ratio	7F 08 99 A2 B3 C4 02 FF 01 88 CF	7F 09 99 A2 B3 C4 02 FF 01 88 XX CF Notes: 00: 16:9 01: P2P; 02: 4:3
Color Gamut	7F 08 99 A2 B3 C4 02 FF 01 89 CF	7F 09 99 A2 B3 C4 02 FF 01 88 XX CF Notes: 00: 16-235; 01: 0-255; 02: Auto.
Backlight brightness	7F 08 99 A2 B3 C4 02 FF 01 49 CF	7F 09 99 A2 B3 C4 02 FF 01 49 XX CF Notes: XX indicates the value of backlight brightness (0 - 100), corresponding to the hexadecimal number system (00 - 64).

10

FAQ&Troubleshooting

Before you contact the technical support staff, please identify a fault according to the following table. If the fault cannot be restored based on the solutions, contact the local distributor for help. For your safety, please do not repair the product by your own.

Failure	Possible Cause	Solution
The service program fails to be connected.	The drive program is not correctly installed.	Install the drive program correctly.
	The USB port (lead) is not connected or is faulty.	Change the USB lead or check if the USB port is faulty.
	The infrared tube is blocked.	Ensure that the surrounding infrared tubes are not blocked.
Repositioning is required every time the panel is switched on.	The computer is equipped with a recovery card.	Disable computer protection and perform the positioning again.
The calibration is inaccurate.	The positioning is not performed properly.	Use the pen provided with the panel to perform positioning again.
Not sound and image	<ul style="list-style-type: none"> • Check whether the power plug is inserted into the power outlet and whether the panel is powered on. • Check whether the rocker switch on the Interactive Flat Panel Display is switched on. • Check whether the power button on the panel is pressed. • Check whether the video and audio input cables are connected correctly. • Check whether the panel is switched to the right signal source. • Check the settings on image brightness and contrast. • Check the volume. 	
Image is normal, but no sound	<ul style="list-style-type: none"> • Check the volume. • Check whether the MUTE button on the remote control is pressed. • Check whether the audio cable between the PC and Interactive Flat Panel Display is connected correctly. 	
No image or the image is black and white	<ul style="list-style-type: none"> • Modify the color settings. • Check the color system. 	

Failure	Possible Cause	Solution
Image or sound is interrupted	<ul style="list-style-type: none"> • Find out the electric appliance that causes the interference and move it away from the Interactive Flat Panel Display. • Do not share the power socket of the panel with the electric appliance that causes interference. 	
The remote control fails	<ul style="list-style-type: none"> • Change the batteries. • Clean the signal emitter at the top of the remote control (Check whether it is blocked). • Check contacts of the batteries. 	
Computer cannot be started (applicable for models with computers)	<ul style="list-style-type: none"> • Check whether the PC adapter is correctly connected and whether the PC is powered on. • Check whether the PC is connected correctly to the Interactive Flat Panel Display. 	

The following symptoms are not faults:

- A very few of constantly bright or dark pixels, such as tiny red, blue, green or dark points, may exist on the LED. This symptom is not a fault and does not affect running functions of the panel.
- Slight sound may occur due to the backlight adjustment or ventilation. This is a normal symptom.
- The image and sound are normal. However, you can sense static electricity when you touch the LED and metal back cover. This is a normal symptom.

11

Maintenance Tips

- Do not put or install the product near a heat source or under direct sunlight, or in dusty or humid places, or somewhere the product may be hit or damaged by mechanical vibration. To maximize the performance, it needs to be put away from equipment such as grid, large metal objects and radar stations as far as possible.
- Do not wipe the panel with any chemical reagent. Solvents may damage the enclosure or paint. If the panel is stained by dust, cut off the power and then clean the panel using a dried cloth with a little of warm water. Use a clean soft cloth to clean the LED of the panel.
- Do not frequently switch on and off the product, which may shorten the product service life. After the panel is switched off, wait for three minutes before switching it on again. If the product is not to be used for a long period, please power off the product and pull out the power plug.
- Do not maximize the brightness and contrast of the LED for a long period of time, which may shorten the LED service life.
- Do not use a hard object to write on the Interactive Flat Panel Display, which may scratch the LED.

12

Clean the Infrared Tube

The Interactive Flat Panel Display uses the horizontal and vertical infrared matrix to detect and locate the user's touch. The screen is surrounded by an infrared tube (including the infrared acceptor and emitter), which forms an infrared net covering on the screen surface. When a user touches the screen, fingers or other opaque objects block the infrared rays that cross the touch point, which helps the controller detect the coordinate position of the touch point. Dust is easily retained on the screen surface due to its long-term exposure in the air and causes ineffective touch or inaccurate positioning. Therefore, you need to clean the infrared tube around the screen regularly.

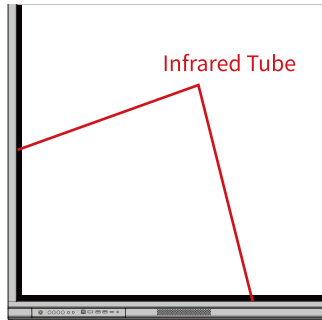

13

Technical Parameters

Model	TT-6523C	TT-7523C	TT-8623C
Display			
Screen Type	LCD (Direct LED Backlight)		
Display Area	1429 x 804 mm	1651 x 929 mm	1896 x 1066 mm
Active Screen Size	65 inch	75 inch	86 inch
Display Ratio	16:9		
Resolution	3840 x 2160 Pixel		
Display Colors	1.07 billion colors		
Brightness	≥ 400 cd/m ²		
Contrast	Typ. 4000:1		
Response Time	≤ 8 ms		
Life Time	≥50000 h (Min.)		
Speaker			
Speaker Position	Bottom Front		
Max.Power Output	2 x 15 W		
Electrical			
Power Consumption	Maximum ≤ 302 W Standby Mode ≤ 0.5 W	Maximum ≤ 343 W Standby Mode ≤ 0.5 W	Maximum ≤ 415W Standby Mode ≤ 0.5 W
Working Voltage	AC100-240V Max. 4.4A	AC100-240V Max. 4.95A	AC100-240V Max. 5.5A

Model	TT-6523C	TT-7523C	TT-8623C
Touch			
Touch Surface	Anti-glare tempered glass		
Transparency	88%±3%		
Touch Points	Windows 40 Points		
Writing Tools	Stylus or Finger		
Transportation/Storage			
Storage Temperature/ Humidity	-20~60°C/0~90%RH (non-condensing)		
Working Temperature/ Humidity	0°C-40°C/20%~80%RH(non-coagulation)		
Mounting (optional)	Wall-mounted / Floor Stand		
Outline Dimension	1512x923x110mm	1735x1048x111mm	1981x1186x111mm
Packing Dimension	1640x185x1030mm	1859x205x1160mm	2119x228x1290mm
Net Weight	approx. 38.5kg	approx. 50kg	approx. 74kg
Gross Weight	40 kg	63 kg	80 kg
Ports			
Front Ports	USB Touch x 1, HDMI1 x 1, USB3.0 x 2, Type-C x 1, Microphone In x 1		
Rear ports	USB2.0 Touch x 1, HDMI 2(ARC)In x 1, HDMI 3 x 1, USB 2.0 x 2 , USB 2.0 Embedded x 1, RS232 x 1, S/PDIF Out x 1, Audio-VGA x 1, Line Out x 1, VGA In x 1, OPS Slots (4K@60Hz)		
Firmware Version	V1.3.2		

NOTE

Manufacturer-reported maximum luminance LMax-Reported is 400cd/m².

For More Information

Please visit our website (<https://newline-interactive.com>) and select your regional website. Once there, navigate to the **Support** section and click on **Downloads**. Choose **C Series** to download the **User Manual** for detailed instructions.

Contact Us for Support

Please directly contact the support team within your region.

USA

Hotline: +1 833 469 9520

Email: support@newline-interactive.com

EMEA

Hotline: +34 91 804 31 79 / +34 680 677 828

Email: support_eu@newline-interactive.com

APAC

Hotline: +886 3 550 4768

Email: info_ap@newline-interactive.com

INDIA

Hotline: 1800-419-0309

Email: info.in@newline-interactive.com

The company is committed to product updates and technical improvements. The technical parameters and specifications are subject to change without prior notice. The pictures in this manual are for reference only.