

# newline



## *PRO SERIES*

### QUICK START GUIDE

## Z Pro Series Buttons

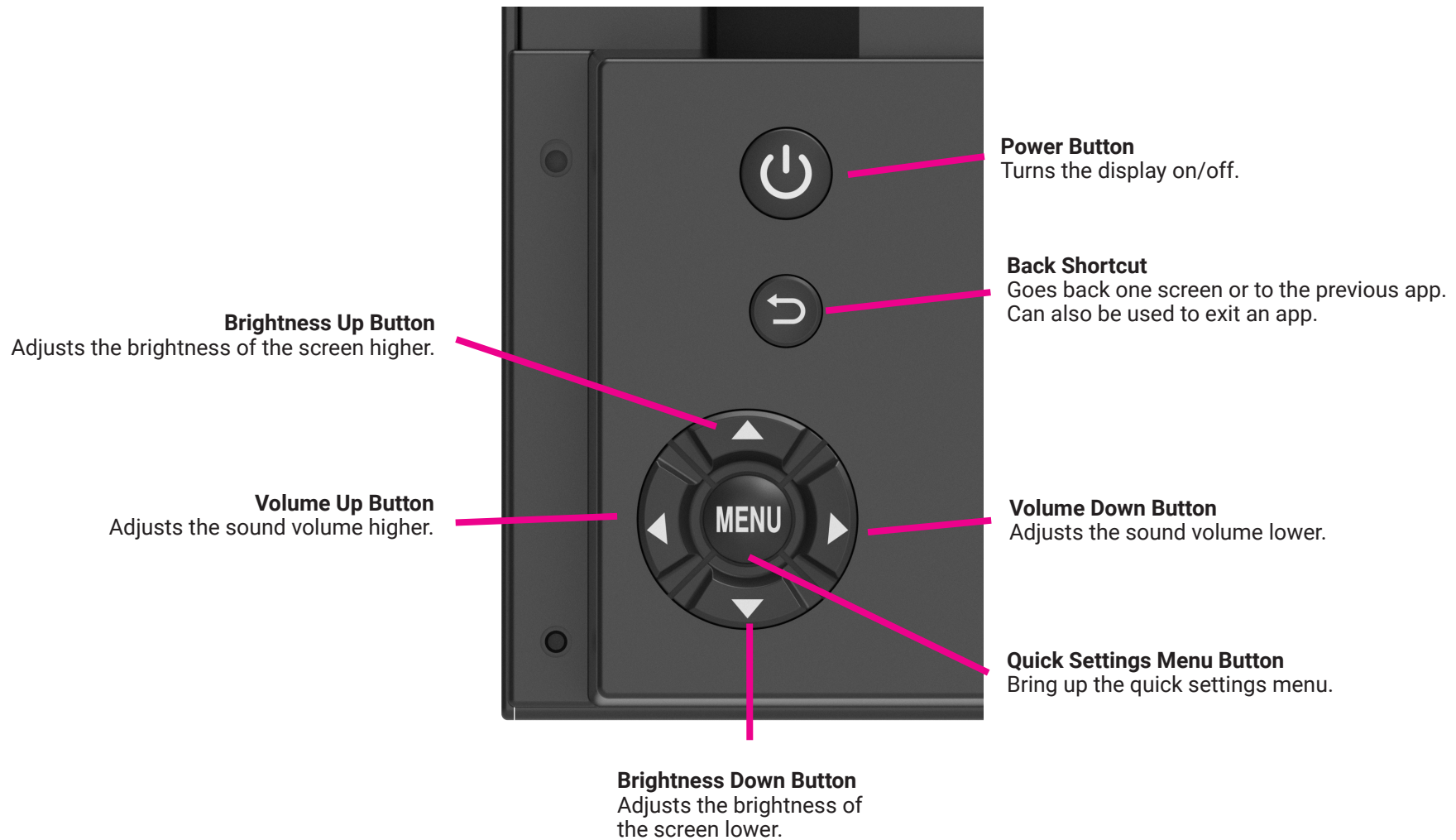

## Turning On the Display

1. Press the Power button on the bottom right side on the back of the display.

# newline | Z Pro Series Quick Start Guide

## Z Pro Series Left Side Panel Ports

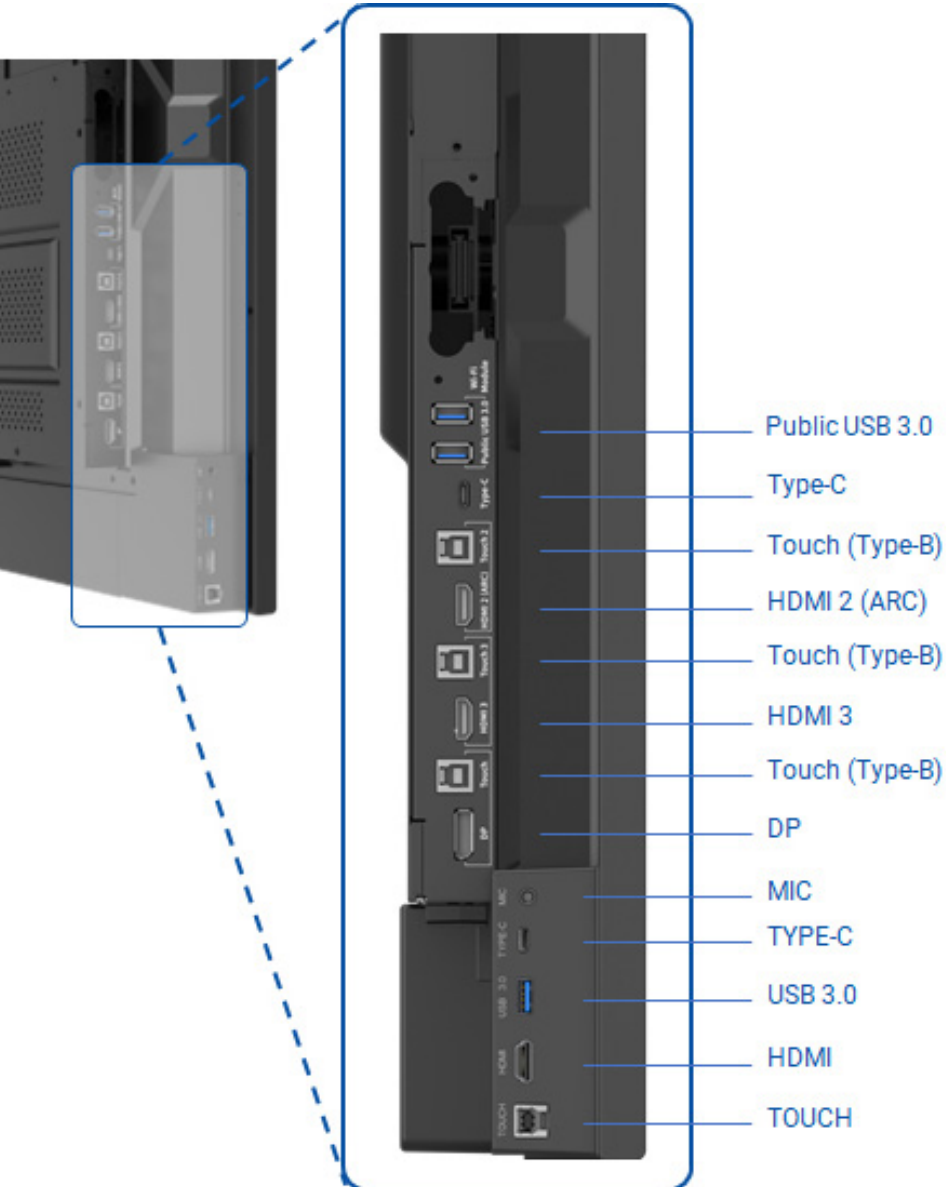

## Z Pro Series Bottom Left Side Panel Ports

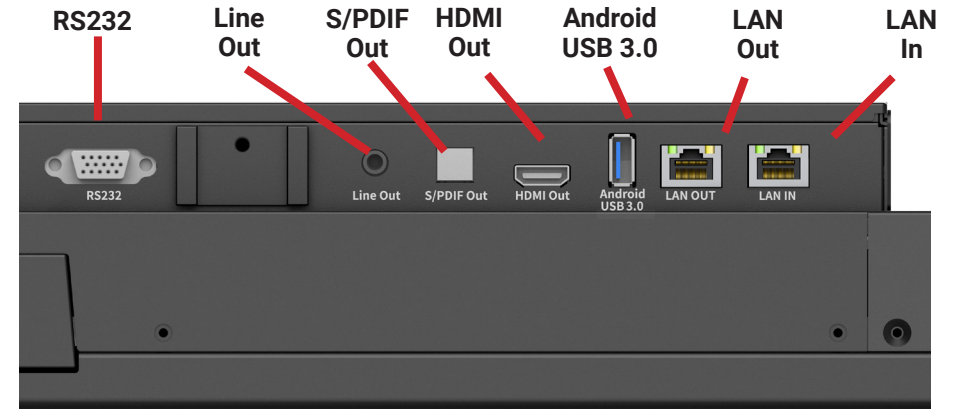

# newline | Z Pro Series Quick Start Guide

## The Home Screen

### Google Search Bar

Search the web and the contents of your panel directly from the homescreen!

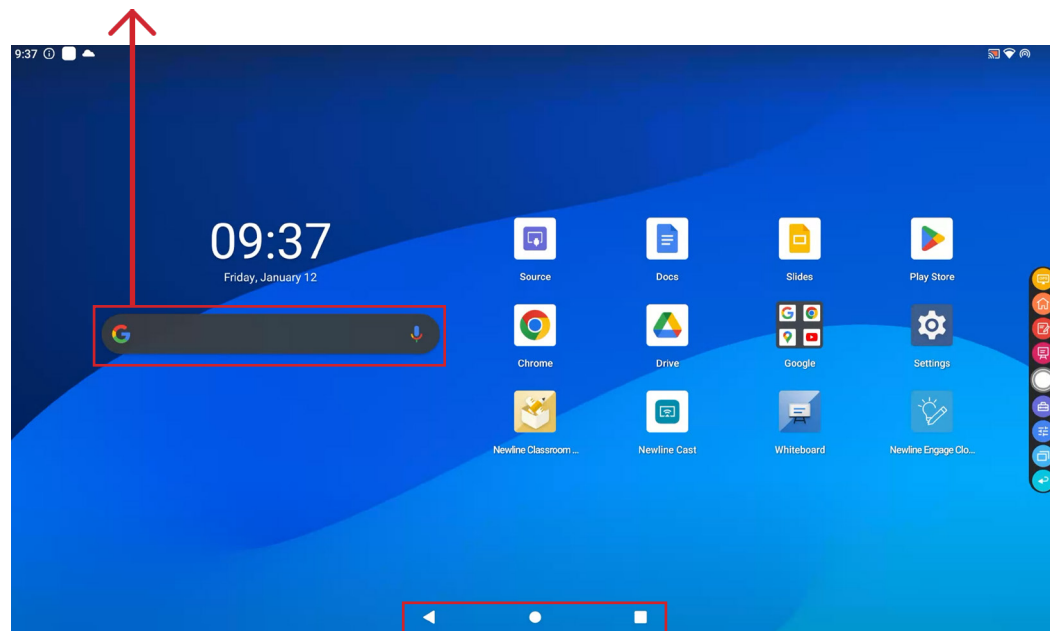

### Android Toolbar

One the bottom of the panel screen is the Android toolbar. Use this toolbar for the following quick access tools:



#### Back

Goes back one screen or to the previous app. Can also be used to exit an app.

#### Home

Takes you to the main Home Screen.

#### Task Switcher

Pulls up all apps currently running on the panel.

## Quick Access Toolbar

The Quick Access Toolbar can be accessed by tapping the white circle on either the left or right side of the screen. To minimize the Quick Access Toolbar, tap the white circle again.



#### OPS Icon

Press and hold on this icon to customize it to your favorite source.

#### Home Shortcut

Takes you to the main Home Screen.

#### Annotation Shortcut

Brings up whiteboarding options on top of whatever is on the current screen. Tap a second time to save a screenshot.

#### Whiteboard Shortcut

Takes you to the whiteboarding screen, letting you draw and takes notes instantly.

#### Quick Access Menu Button

Tap to open the Quick Access Menu. Tap again to minimize the menu.

#### Quick Access Bar

Opens up a menu to quickly access Classroom tools, calendar, calculator, clock, and more.

#### Sound Settings

Opens up a menu where you can adjust the sound settings.

#### Running Apps Shortcut

Pulls up all apps currently running on the panel.

#### Back Shortcut

Goes back one screen or to the previous app. Can also be used to exit an app.

## Moving Apps to Customize Home Screen

1. On the home screen, **long press** on any app to move its location. The panel will show you where you can place an app by creating a white rectangle in your desired location.

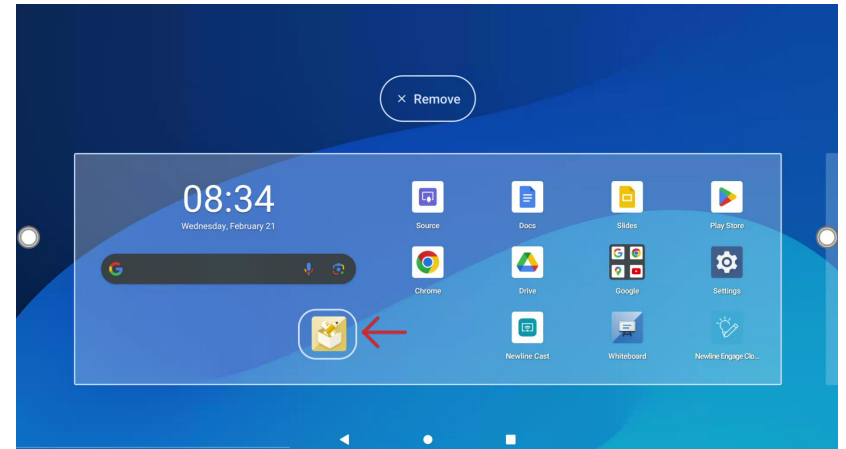
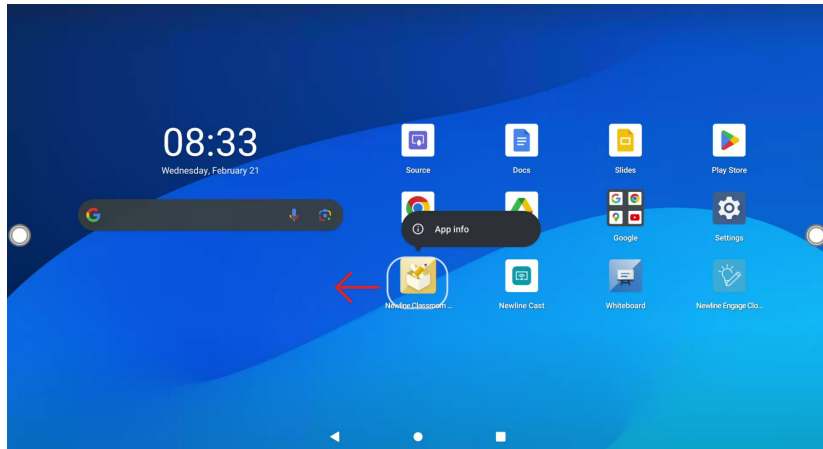

### Bonus Tip:

To create a folder of multiple apps, simply move one app on top of another app. A folder will be created automatically. Long press on the folder to rename the folder.



### Bonus Tip:

By long pressing, you also have the option to remove the app from the home screen or uninstall the app completely.

# newline | Z Pro Series Quick Start Guide

## Switching Sources

1. Tap the Source icon on the home screen.
2. Any device currently connected to the display will light up in white in the Source window on the home screen.
3. Tap the icon of the source you want to switch to.
4. Plugging your device into the front ports will automatically bring up the device on screen.

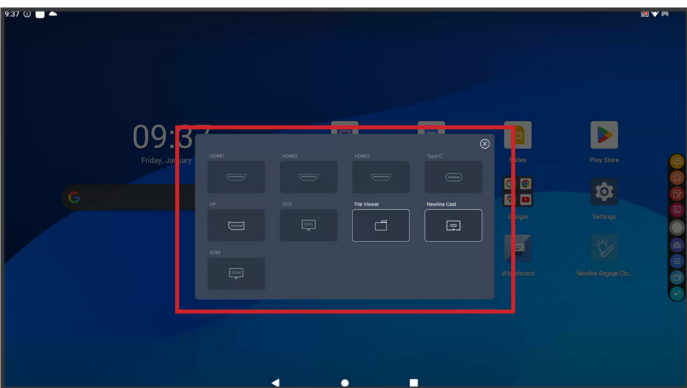
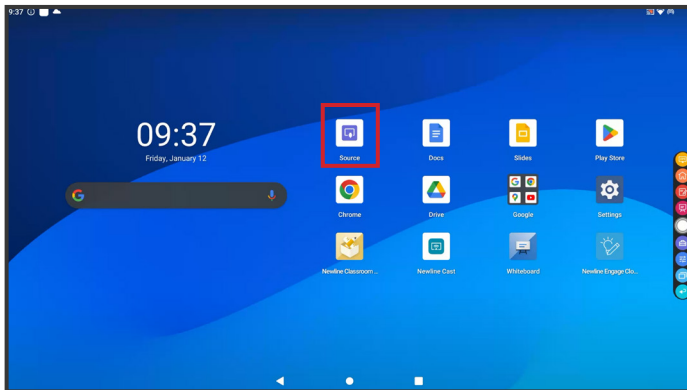

## Accessing the Built-In OPS Computer

1. Tap the Source icon on the home screen.
2. In the Source window that pops up, tap on the "OPS" button.
3. You will now be viewing and using the built-in OPS Computer.

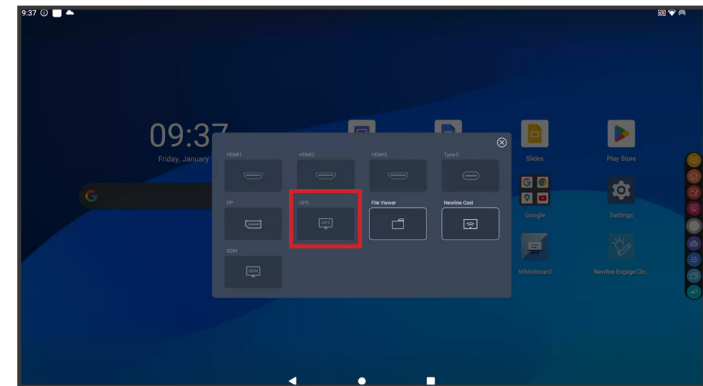
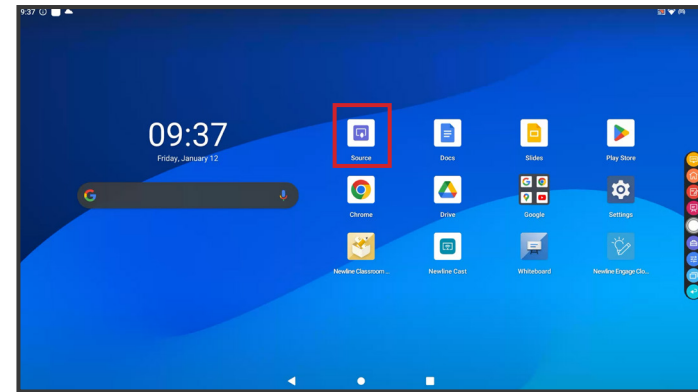

## Switching Sources

### Connecting a Computer with USB-C

1. You will need a USB Type-C cable to connect a computer.
2. Plug in one end of the USB-C cable into the left side USB-C port.
3. Take the other end of the USB-C port and plug it into the USB-C port on your computer.
4. Once both cables have been plugged into the display and the computer, the matching port should turn white on the Source window.

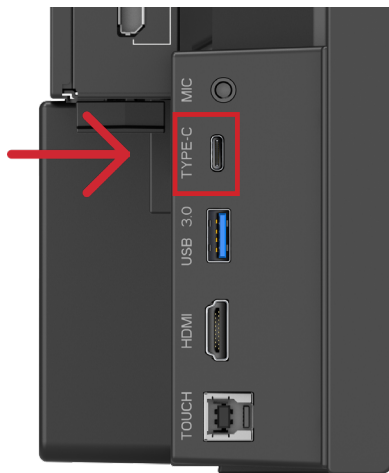

## Switching Sources

### Connecting a Computer with USB & HDMI

1. You will need an HDMI cable and a USB A to B cable to connect a computer.
2. On the left side ports of the Z Pro Series, plug in one end of the HDMI cable into one of the HDMI ports.
3. Take the other end of the HDMI port and plug it into the HDMI port on your computer.
4. Plug in the USB-B end of the USB cable into one of the front or side ports labeled "USB Touch."
5. Take the USB-A end of the USB cable and plug it into the USB port on your computer.
6. Once both cables have been plugged into the display and the computer, the matching port should turn white on the Source window.



## Installing the Wi-Fi Module

1. Unscrew the 2 screws on the Wi-Fi Module port and remove the shielding cover.



2. Insert the Wi-Fi Module into the port on the rear of the panel until firmly seated, using the 2 screws to secure it.

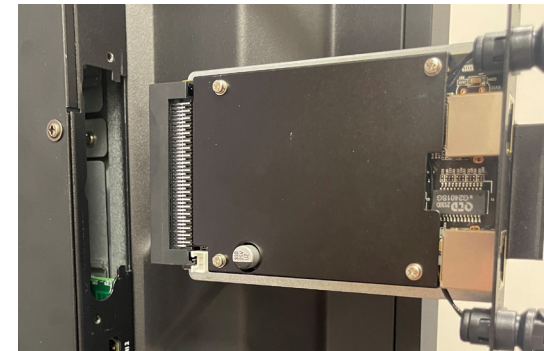

### Caution

The Wi-Fi Module does not support hot plugging. Therefore, you must insert or remove the Wi-Fi Module when the display is powered off. Otherwise, the displays or Wi-Fi Module may be damaged.





# newline | Z Pro Series Quick Start Guide

## Changing the Settings

1. From the home screen, select the Settings menu item.
2. From the Settings menu, you can adjust things like the Power settings, Internet Network settings, Date & Time, Wallpapers, and more.

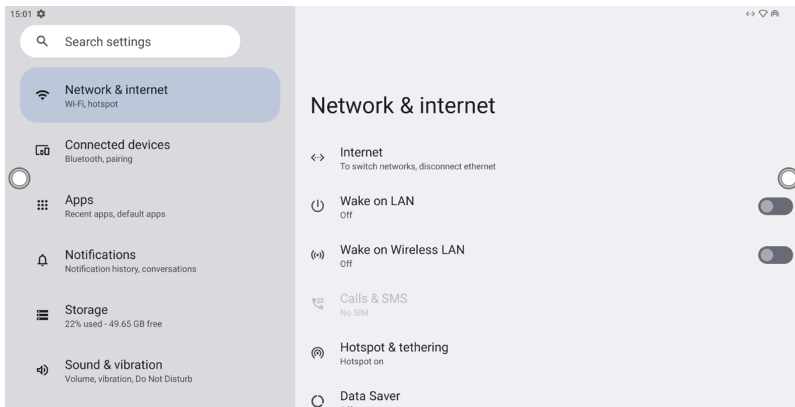
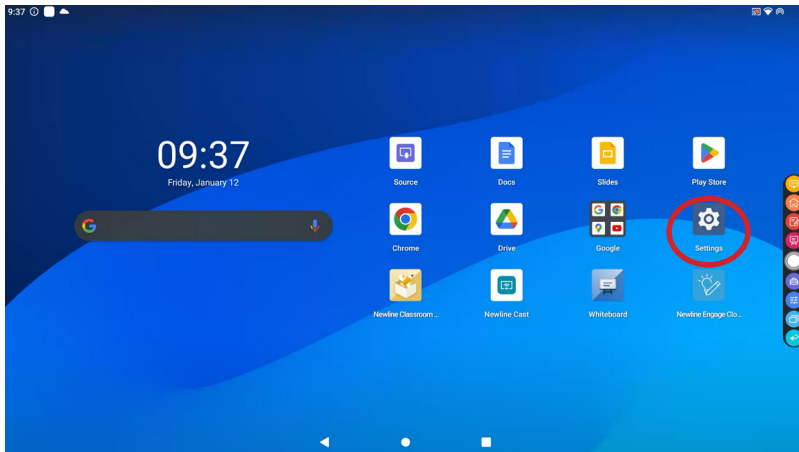

## Launching Updates

Updates to Firmware and Apps launch automatically “over the air.” A pop-up item will appear on the screen when the update is ready to be downloaded.

# newline | Z Pro Series Quick Start Guide

## How to Enable a QR Code Login

This is a convenient way for teachers/users to log into their account without their PIN being revealed.

1. Navigate into the panel's 'Settings'.

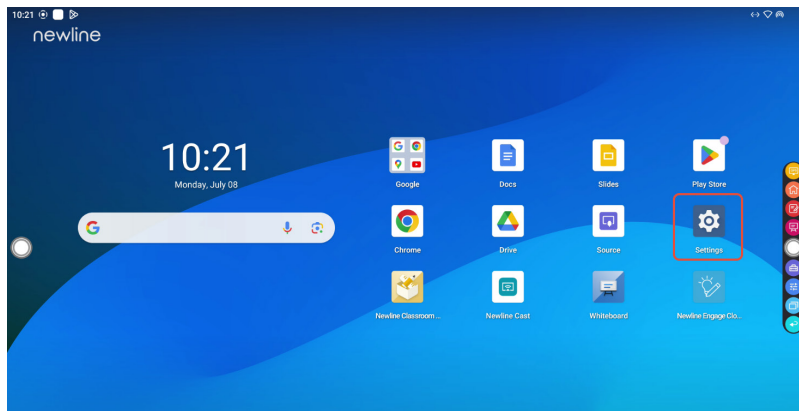

2. Then, scroll down and select 'Security'.
3. Select the gear (Settings) icon to the right of 'Screen lock'.

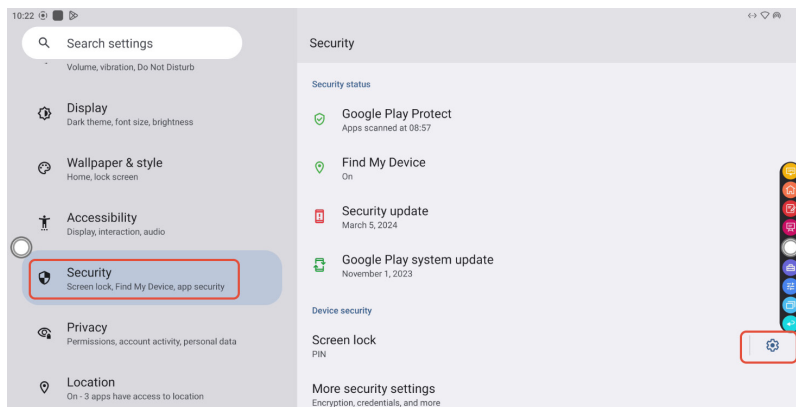

4. Toggle 'QR Code' to the right, 'ON', to enable this setting.

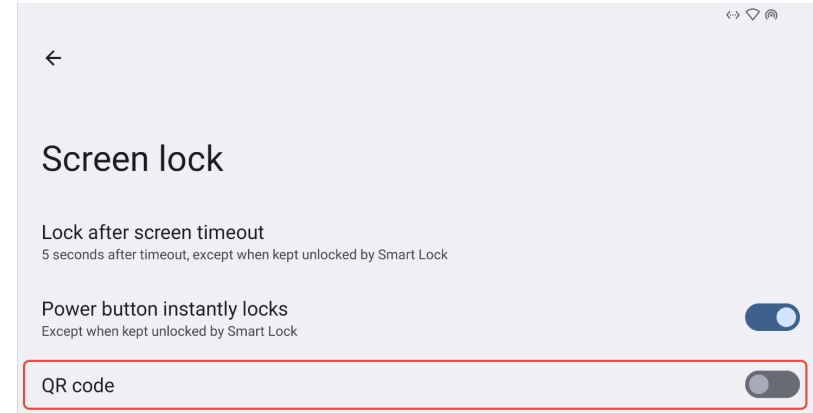

## How to Hide Your PIN While Logging In

The result will be that the censored password shows in the text box, and the numbers on the PIN pad do not light up, so the only way students would see anything is by watching the teacher put in the code (which the teacher can angle away from students for privacy, if on a mobile cart).

1. Navigate into the panel's 'Settings'.

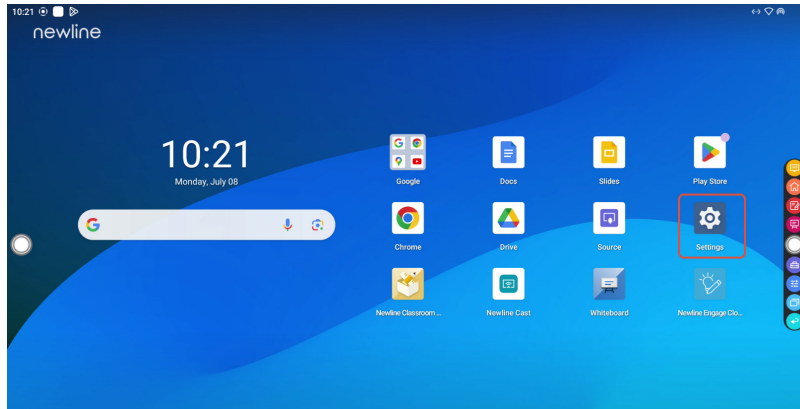

2. Then, scroll down and select 'Privacy'.
3. Toggle OFF 'Show passwords'.

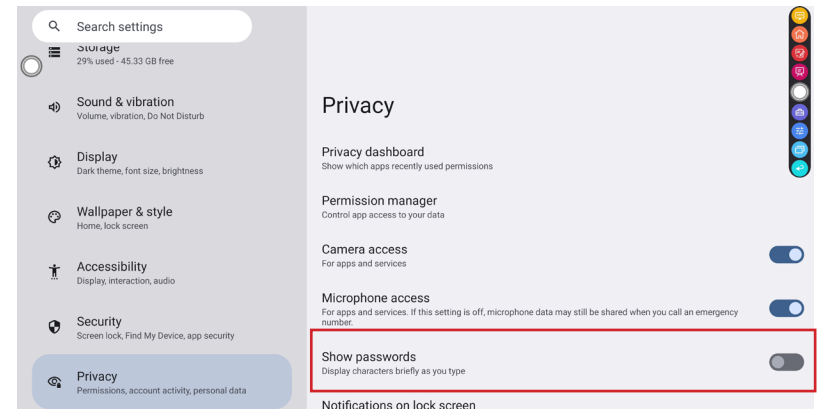

## Whiteboard Tools

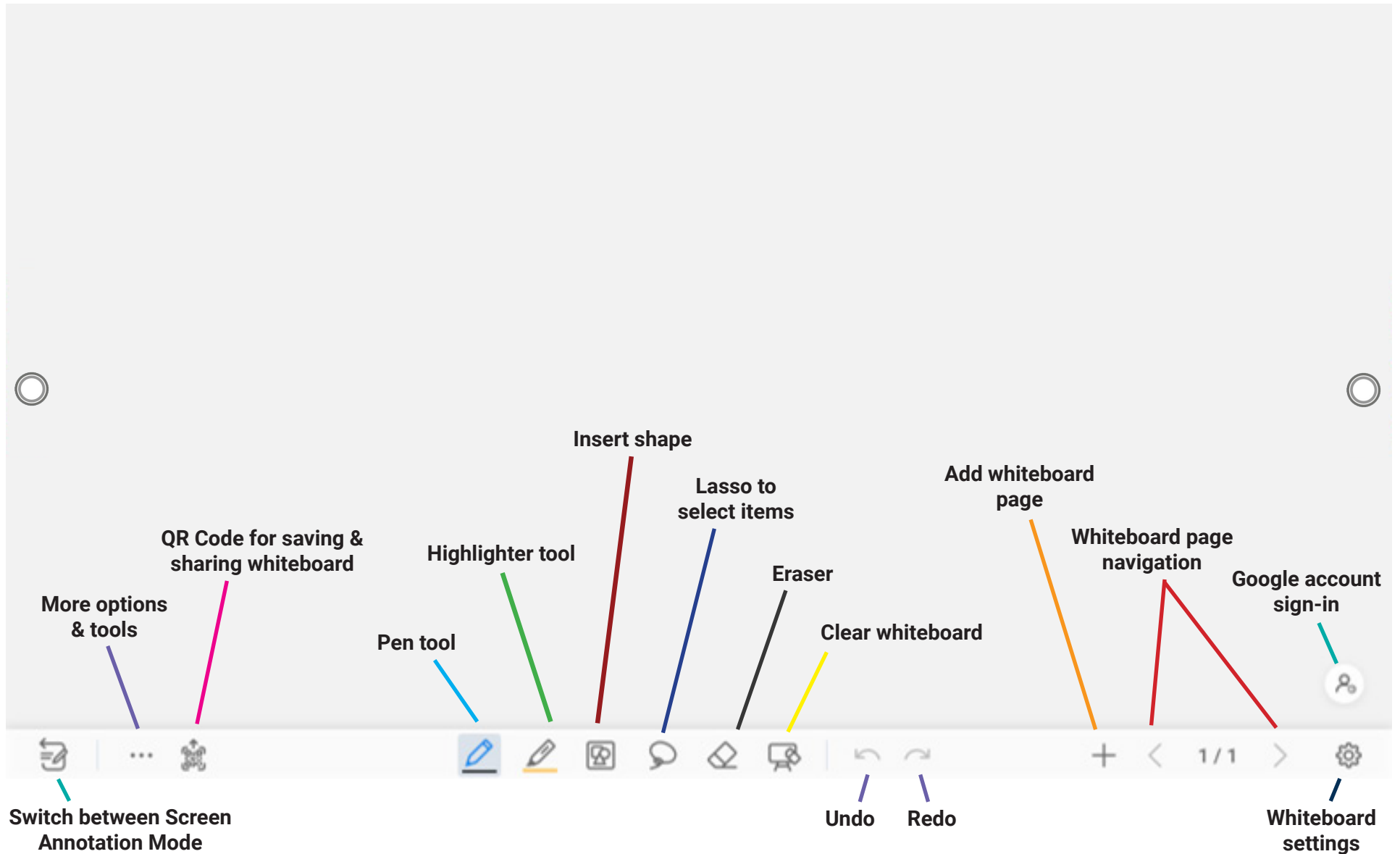

## Annotation Tools

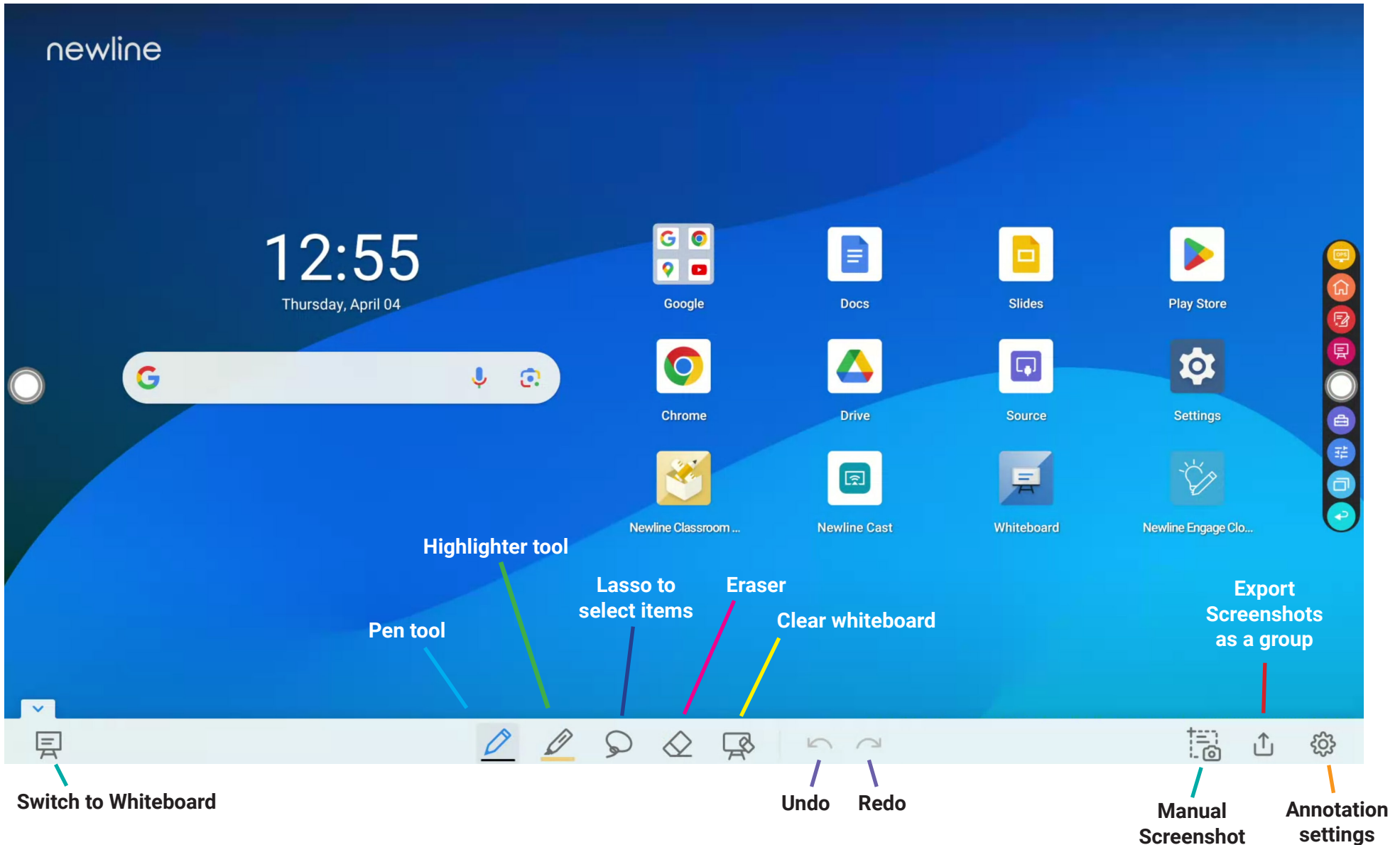

# newline | Z Pro Series Quick Start Guide

## Accessing the Google Play Store

1. On the Home Screen, tap on the "Google Play Store" button.

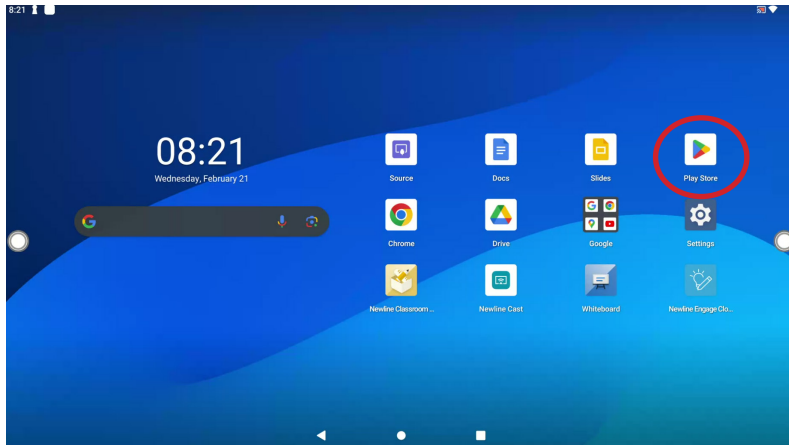

2. In the Google Play Store, search and select the App you want to download.

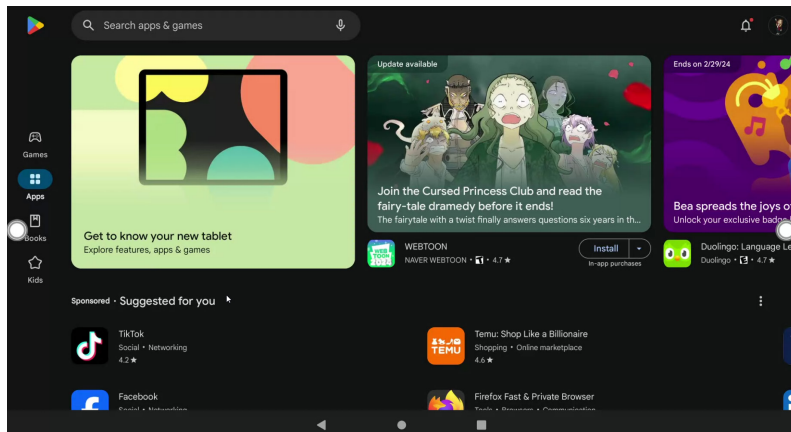

3. On the App details screen, tap Install.

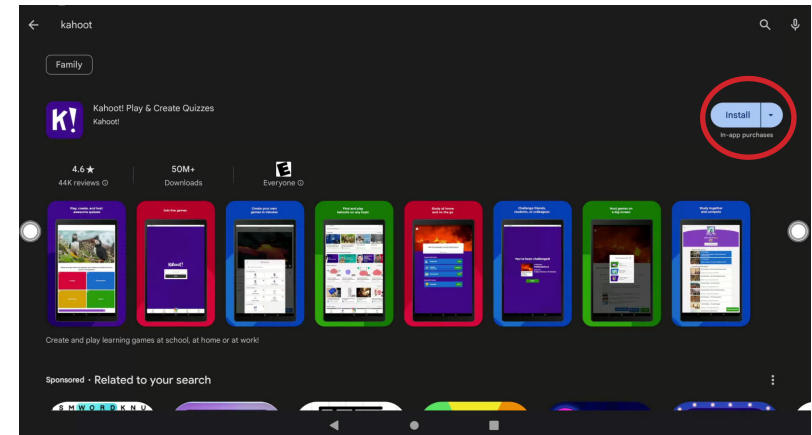

4. Once installed, new apps will appear on the second of the home screen. Swipe left to access this page. If you want to move the location of your downloaded apps, see page 5.

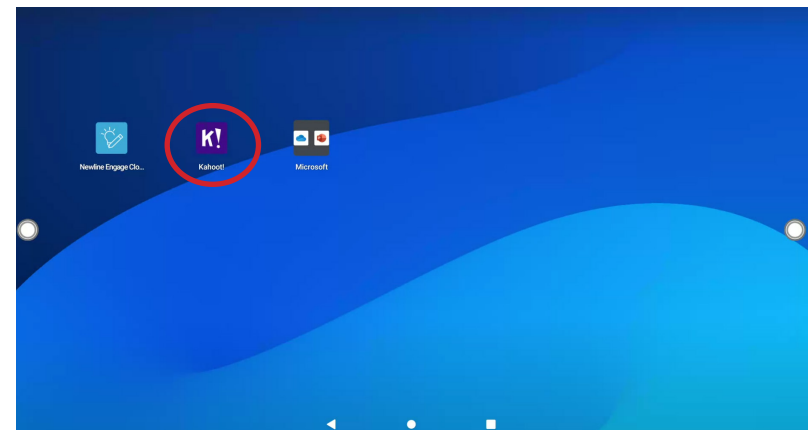

## Using Newline Cast

### Connecting to Newline Cast Using the DisplayNote Windows App

1. Open the Newline Cast app on your display.

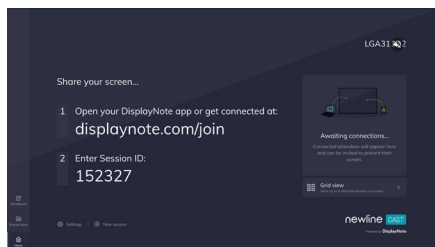

2. Download the DisplayNote Windows App from [displaynote.com/join](https://displaynote.com/join) on your computer.
3. Open the DisplayNote app on your laptop.
4. Type in the Session ID you see on the display and your name.
5. Select "Join" once both Session ID and Name are filled in.

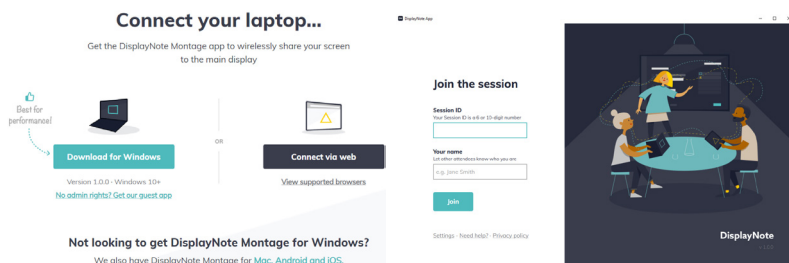

### Connecting to Newline Cast from a Web Browser

1. Open the Newline Cast app on your display.
2. Visit [www.displaynote.com/join](https://www.displaynote.com/join) on your laptop and select "Connect via web."
3. Type in the Session ID you see on the display and your name.
4. Select "Join" once both Session ID and Name are filled in.
5. When asked, select whether you want to share your entire screen, or just a specific application window.
6. Click "Share."

## Using Newline Broadcast

### Share your Panel Screen to Student Devices

1. Turn on the display.
2. Begin a session by opening the Broadcast application and pressing the "Start broadcast" button.
3. Share the public share link with your viewers.
4. Begin your presentation.
5. To end the Broadcast, press the Stop Broadcast button.

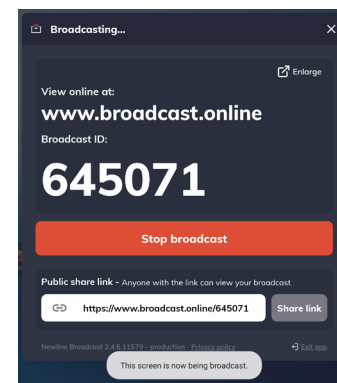

### Viewing a Broadcast

1. Click the link sent by the broadcast host, or go to [broadcast.online](https://www.broadcast.online), enter the 6-digit Broadcast ID and press Connect.
2. Users can interact with the "Enlarge" option to enlarge the broadcast information. This is designed to help users view the broadcast information from afar.
3. To leave a broadcast, press the Stop button at any time.



newline

350 W Bethany Dr  
Suite 330  
Allen, TX 75013

1-888-233-0868

[info@newline-interactive.com](mailto:info@newline-interactive.com)

To learn more, visit: [www.newline-interactive.com](http://www.newline-interactive.com)