

---

# **Ultra Series**

Interactive Flat Panel Display  
**User Manual**

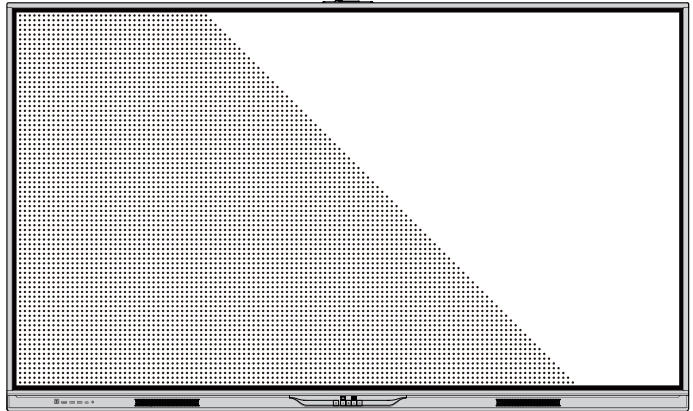

newline

# Contents

.....

<b>About This Document</b> .....	<b>01</b>
<b>Safety Instruction</b> .....	<b>02</b>
<b>1.Overview</b> .....	<b>06</b>
1.1 Introduction .....	06
1.2 Parts .....	06
1.3 Ports .....	08
1.4 Front Buttons .....	10
1.5 Remote Control .....	11
1.6 AI Remote Control (Optional) .....	12
<b>2.Installation Guide</b> .....	<b>13</b>
2.1 Safety Precautions .....	13
2.2 Installation Precautions .....	13
2.3 Installation.....	15
2.4 Installing the OPS (Optional) .....	17
2.5 Installing the Camera(Optional) .....	17
2.6 Installing Newline Assistant.....	18
2.6.1 Introduction .....	18
2.6.2 Installation .....	18
<b>3.Getting Started</b> .....	<b>19</b>
3.1 Power On.....	19
3.2 Power Off .....	19
3.3 Calibration .....	20
<b>4.Operating</b> .....	<b>23</b>
4.1 Profile Login .....	23
4.2 Home .....	23
4.3 Whiteboard.....	28
4.3.1 Whiteboard Functions.....	30
4.3.2 Whiteboard Setting.....	37
4.3.3 Page Operations.....	40
4.3.4 ClassConnect .....	41
4.3.5 Annotation.....	42
4.4 Application .....	44
4.4.1 Google Play Store .....	44
4.4.2 Newline Display Management+ .....	45

4.4.3 Newline Cast	45
4.4.4 Newline Signage Pro	46
4.4.5 Newline Classroom Tools	46
4.4.6 Newline Secure	58
4.4.7 Voice Assistant	58
4.4.8 Files	58
4.4.9 Visualizer	59
4.4.10 Vote	60
4.4.11 Reminders	61
4.4.12 Newline App Store	64
4.4.13 File Management	64
4.4.13.1 File Viewer Page	64
4.4.13.2 File Preview	65
4.4.13.3 File Filtering	65
4.4.13.4 New Folder	66
4.4.13.5 File Operation	66
4.5 Extended Functions	66
4.5.1 Capture	67
4.5.2 Sources	68
4.5.3 Quick Setting Menu	68
4.5.4 Automatically Power Off	69
4.6 Settings	70
4.6.1 Network & Internet	70
4.6.2 Newline Settings	71
4.6.2.1 Power	70
4.6.2.2 Sound	70
4.6.2.3 Camera	72
4.6.2.4 Input & Output	72
4.6.2.5 Display Option	73
4.6.2.6 Toolbar	73
4.6.2.7 Screen Eye Filters	73
4.6.2.8 Advanced	75
4.6.3 Connected devices	77
4.6.4 Apps	77
4.6.5 Notifications	77

4.6.6 Storage .....	79
4.6.7 Sound and vibration .....	79
4.6.8 Display .....	80
4.6.9 Wallpaper & Style .....	80
4.6.10 Accessibility .....	81
4.6.11 Security & privacy .....	82
4.6.12 Location .....	82
4.6.13 Passwords, Passkeys & Account .....	83
4.6.14 Google .....	83
4.6.15 System .....	83
4.6.16 About Tablet .....	86
<b>5 Serial Port Control .....</b>	<b>88</b>
<b>6 FAQs &amp; Troubleshooting .....</b>	<b>94</b>
<b>7 Specifications .....</b>	<b>96</b>
<b>8 More Information .....</b>	<b>101</b>

Welcome to the world of Newline.

Thank you for choosing the Q Ultra series Interactive Flat panel display. Please use this document to get the most out of your screen.

---

This device complies with part 15 of the FCC Rules. Operation is subject to the following two conditions: (1) This device may not cause harmful interference, and (2) this device must accept any interference received, including interference that may cause undesired operation.

NOTE 1: This equipment has been tested and found to comply with the limits for a Class B digital device, pursuant to part 15 of the FCC Rules. These limits are designed to provide reasonable protection against harmful interference in a residential installation. This equipment generates, uses, and can radiate radio frequency energy and, if not installed and used in accordance with the instructions, may cause harmful interference to radio communications. However, there is no guarantee that interference will not occur in a particular installation. If this equipment does cause harmful interference to radio or television reception, which can be determined by turning the equipment off and on, the user is encouraged to try to correct the interference by one or more of the following measures:

- Reorient or relocate the receiving antenna.
- Increase the separation between the equipment and receiver.
- Connect the equipment into an outlet on a circuit different from that to which the receiver is connected.
- Consult the dealer or an experienced radio/TV technician for help.

NOTE 2: Any changes or modifications to this unit not expressly approved by the party responsible for compliance could void the user's authority to operate the equipment.

---

The symbol of the crossed out wheeled bin indicates this product should not be placed in municipal waste. Instead, dispose of waste equipment by taking it to a designated collection point for electrical and electronic equipment recycling.



## Energy Star Compliance



### **Signage Displays with Plug-in Module.**

As an ENERGY STAR Partner, Newline Interactive Inc., has followed the EPA's enhanced Product qualification and certification process to ensure that the products marked with the ENERGY STAR logo are ENERGY STAR qualified per the applicable ENERGY STAR guidelines for energy efficiency. The logo appears on the pen tray near front connections on all ENERGY STAR qualified Signage Displays.

The ENERGY STAR program for Signage Displays was created by EPA to promote energy efficiency and reduce air pollution through more energy-efficient equipment in offices, classrooms and factories. One way that a product achieve this goal is by using a power management feature to reduce power consumption when the product is not in use.

For TT-5526QULT, TT-6526QULT, TT-7526QULT, TT-8626QULT and TT-9826QULT, sleep mode can be initiated in a couple different ways. Users can take the action of pressing the power button on the panel, or a remote command can be sent via RS232. The panel will also go into sleep mode without user action after one hour of inactivity.

TT-5526QULT, TT-6526QULT, TT-7526QULT, TT-8626QULT and TT-9826QULT can exit sleep mode by the user pressing the power button, or by the proximity sensors detecting a user's presence, or through a remote command via RS232. In the event of a proximity detection, the panel will transition from sleep mode to another low power mode, STAND BY.

In the event that brightness settings or power mode settings are changed by the user, energy consumption of the panel may increase beyond the limits required for ENERGY STAR certification.

Additional information on the ENERGY STAR program and its environmental benefits are available on the EPA ENERGY STAR Power Management website at <http://www.energystar.gov/powermanagement>.

Additional information on the ENERGY STAR program and its environment benefits are available on the EPA ENERGY STAR website at <http://www.energystar.gov>

For production, above information will need to be available for the Energy Star V8 build from 27<sup>th</sup> January 2020.

Manufacturer-reported maximum luminance LMax Reported is 500cd/m<sup>2</sup>.

## Crestron Connected® Certified Integration

# CRESTRON CONNECTED

Newline interactive displays are Crestron Connected® certified, enabling effortless integration into professional AV environments powered by the Crestron XiO Cloud® platform.

Designed for modern workplaces and learning spaces, this certification allows IT teams to centrally monitor, manage, and control devices at scale—delivering a smarter, more efficient, and fully connected experience.

With Newline and Crestron integration, you can:

Integrate seamlessly into existing Crestron ecosystems

Manage devices remotely with real-time visibility and control

Streamline deployment and maintenance, reducing operational complexity

Ensure secure, scalable performance across multiple locations

By combining Newline's intuitive display technology with Crestron's industry-leading control system, organizations can unlock greater efficiency, simplified workflows, and enhanced user experiences.

For more information, visit:





<https://www.crestron.com/Partners/Integrated-Partners/Crestron-Connected>

# About This Document

.....





This document describes multiple functions, instructions, and notes about the product.

Symbols are used in this document to indicate operations that need particular attention. The symbols are defined as follows:

 <b>NOTE</b>	Provides additional information to supplement operation in the main text.
 <b>TIP</b>	Provides tips for operation.
 <b>CAUTION</b>	Indicates a potentially hazardous situation that, if not avoided, could result in equipment damage, data loss, performance deterioration, or unanticipated results.
 <b>WARNING</b>	Indicates a hazard with risk that, if not avoided, could result in death or injury.

# Safety Instruction

For your safety, please read the following instruction before you use the product. Serious injury or property damage may be caused by improper operations. Do not try to repair the product on your own.

 <b>WARNING</b>	
	<p><b>Disconnect the product from the power supply immediately if major failures occur.</b></p> <p>Major failures include the following:</p> <ul style="list-style-type: none"> <li>• If smoke, a peculiar smell or an abnormal sound is discharged from the product.</li> <li>• No image or sound is displayed, or the image error occurs.</li> </ul> <p>In the preceding scenarios, do not continue to use the product. Disconnect power supply immediately and contact professional staff for troubleshooting.</p>
	<p><b>Do not drop any liquids, metal or anything combustible onto the product.</b></p> <ul style="list-style-type: none"> <li>• If any liquids or metal are dropped onto or into the product, power off the product and disconnect the power supply. Then contact professional staff for solutions.</li> <li>• Pay attention to children when they are close to the product.</li> </ul> <p><b>Put the product on a stable surface.</b></p> <p>An unstable surface includes, and is not limited to, an inclined plane, a shaky stand, desk or platform, that might cause the product to turnover and be damaged.</p>
	<p><b>Do not open the panel or change the product on your own.</b></p> <p>High voltage components are installed in the product. When you open the panel, high voltage, electric shock, or other dangerous situations may occur. If inspection, adjustment, or maintenance is required, contact the local distributor for help.</p>
	<p><b>Use the provided power supply.</b></p> <ul style="list-style-type: none"> <li>• To prevent the product from being damaged, do not use any types of power cables other than the one provided with the product.</li> <li>• Use a three-wire socket and ensure that it is properly grounded.</li> <li>• Pull out the power plug from the socket if the product is not used for a long period.</li> </ul> <p><b>Clean the power plug regularly.</b></p> <ul style="list-style-type: none"> <li>• Fire or electric shock may be caused if the product is powered on while you are cleaning.</li> <li>• Pull out the power plug before cleaning it with a dried cloth.</li> </ul>

## WARNING



### **Do not put items on the top of the product.**

- Do not put items, such as a container for liquid (a vase, flowerpot, cosmetics or liquid medicine) on the top of the product.
- If any water or liquid is spilled on the product, the product may short circuit and cause fire or electric shock.
- Do not walk on or hang any items on the product.



### **Do not install the product in an improper place.**

- Do not install the product in humid places, such as the bathroom, the shower room, near windows, or outdoor environments that experience rain, snow, or other harsh weather. Avoid installation near hot spring vapor. The preceding environments may cause faults in the product or electric shock under extreme conditions.
- Do not put an exposed fire source, such as a lit candle on the product.



### **Pull out the power supply during thunderstorms.**

- Do not touch the product during a lightning storm, you may experience an electric shock.
- Install or place components that supply high enough voltage to cause personal injury out of the reach of children.



### **Do not touch the power cable with wet hands.**

## CAUTION



### **Do not install the product in high temperature environments.**

- Do not install the product near a heat source, such as a radiator, a heat reservoir, a stove or other heating products.
- Do not expose the product to direct sunlight, which may cause high temperatures and subsequent faults in the product.



### **When transporting the product:**

- Pack the product for transport or maintenance by using the cartons and cushioning material provided with the product.
- Move the product vertically during transport. The screen or other components are easily broken if the product is moved in an improper way.
- Before you move the product, disconnect all external connections and separate all topple preventing products. Move the product carefully to prevent it from being hit or squeezed, especially the screen, which may cause injury if broken.

## CAUTION



### **Do not cover or block up any vents on the product.**

- Any overheated components may cause fire, damage the product, and shorten the service life.
- Do not lay the product down in a way where the venting surface will be covered.
- Do not install the product on carpet or cloth.
- Do not use a cloth such as table cloth to cover the product.

### **Keep the product away from the radio.**

The product complies with the international EMI standard to prevent radio interference. However, interference may still exist and cause noise in the radio. If noise occurs in the radio, try the following solutions.

- Adjust the direction of the radio antenna to avoid the interference from the product.
- Keep the radio away from the product.

### **If the screen glass is broken or falls off.**

- Keep all personnel 10 feet away from the screen to ensure safety.
- Do not perform any installation or disassembly while the screen glass is broken or has fallen off.



### **Use the battery correctly.**

- Galvanic corrosion, electric leakage, and even fire may be caused by improper battery usage.
- It is recommended to use the designated type of battery and install the battery by the correct electrodes (positive and negative).
- Do not install and use a new battery with a used one.
- Take out the battery if the remote control is not used for a long period.
- Do not expose the battery to overheated environments, such as sunlight and other heat sources.
- Dispose of the used battery based on your local regulations.

### **Do not damage the power cable.**

- Do not damage, change, twist, bend, or forcibly drag the power cable.
- Do not put weights (such as the product itself) on the power cable.
- Do not forcibly drag the cable when you pull out the power plug. If the power cable is damaged, please contact the local distributor to repair or replace it.
- The power cable in the accessory box is for this product only. Do not use it on other products.

## CAUTION



### **Additional advice:**

- Use the product in an environment with comfortable lighting. It is harmful to your eyes to watch in a too bright or too dark environment.
- Relax your eyes watching for a period of time.
- Keep sufficient distance from the product to protect your eyes and prevent eyestrain. The recommended viewing distances are as follows, TT-5526QULT / TT-6526QULT: 2750mm, TT-7526QULT: 2910mm, TT-8626QULT: 3360mm, TT-9826QULT: 3827mm.
- Adjust the volume to an appropriate level, especially at night.
- Excessive sound pressure from ear-/headphones can cause hearing damage/ hearing loss.
- Adjustment of the volume control as well as the equalizer to other settings than the center position may increase the ear-/headphones output voltage and therefore the sound pressure level.
- The use of factors influencing the ear-/headphones output other than those specified by the manufacturer (e.g. operating system, equalizer software, firmware, driver) may increase the ear-/headphones output voltage and therefore the sound pressure level.
- The use of ear-/headphones other than those specified by the manufacturer may lead to heightened sound pressure level.
- Use amplifier equipment as the audio input source with caution. If you must use amplifier equipment, the input power should not exceed the maximum of speaker power. Otherwise, the speaker can become overpowered and damaged.

### **About USB port.**

Front USB 3.0 ports and rear Public USB 3.0 ports switch connections based on signal sources. If the current signal source is reading the data from an external product connecting to the port, please switch the signal source after the data reading is complete. Otherwise, the data or product may be damaged.

# 1

# Overview

## 1.1 Introduction

Take collaboration to the next level with the Q Ultra series interactive display.

Increase productivity and collaboration across the board with a display that uses advanced touch technology.

Each product can be customized to fit your needs. The non-proprietary nature lets you use the software you prefer, take notes on local files, wirelessly cast to the screen from smaller devices, run your favorite apps, and view multimedia files, all while making your experience better than before.

The newline's 4K Ultra High-Definition LED screen also provides a fluid writing experience. Annotate over anything on the screen, whether in the embedded whiteboard or while using any other device. IntelliTouch automatically identifies pen thickness and color, saving your time.

## 1.2 Parts

- Front View

55/65/75/86/98inch:

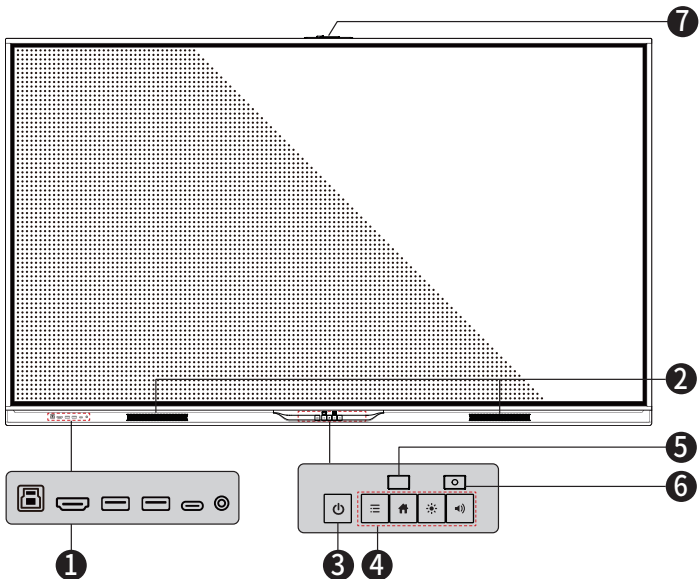

- Rear View

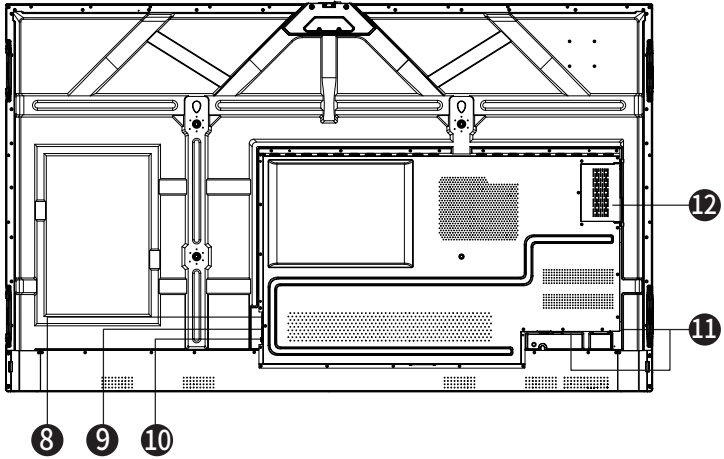

①	Front Ports	⑦	Camera Port
②	Speakers	⑧	Power Output Plug
③	Power On/Off	⑨	Power Supply Plug
④	Front Buttons	⑩	Power Switch
⑤	Remote Control Receiver	⑪	Rear Ports
⑥	Light Sensor	⑫	OPS Port

#### 📖 Notes

- The product images shown are for illustration purposes only and may not be an exact representation of the product.

## 1.3 Ports

### CAUTION

- Front USB 3.0 ports and rear Public USB 3.0 ports switch connections based on signal sources. If the current signal source is reading the data from an external product connecting to the port, please switch the signal source after the data reading is complete. Otherwise, the data or product may be damaged.
- For USB use, USB 3.0 provides up to 900mA of power. Please make sure the USB flash drive is formatted to FAT32 before inserting into the panel.
- Please use the supplied cable in the accessory box or the HDMI association certified shielded cable to better ensure the signal quality.
- While HDMI and Display Port offer support for cables of varying lengths, the maximum cable length that Newline recommends for optimal performance is 3 meters (10 feet) for HDMI and 1.8 meters (around 6 feet) for Display Port. Using cable longer than recommended length may cause data loss and a negative impact to display quality.

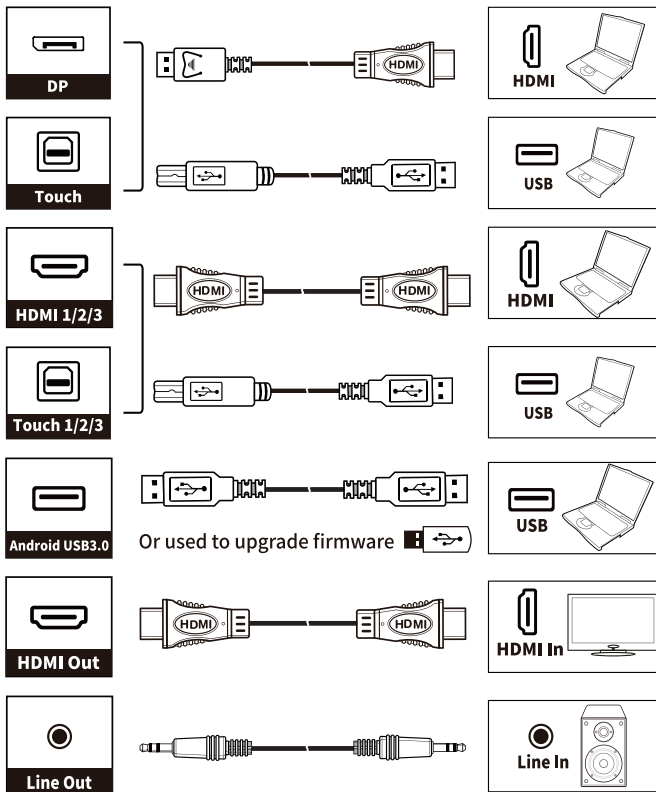

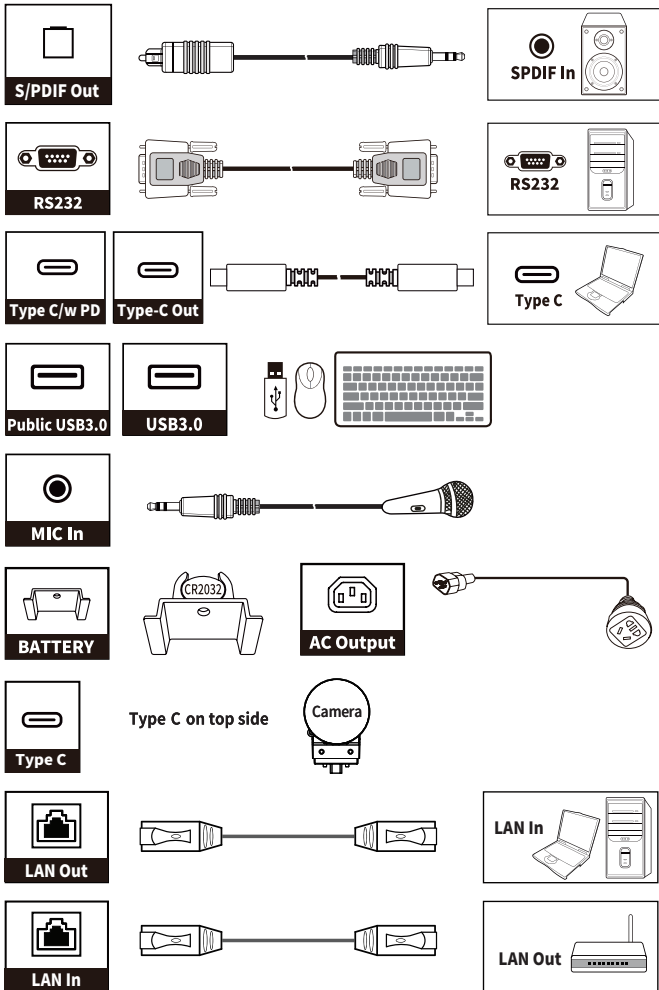





## WARNING

The rear power output port supplies 180W (maximum) power. Please contact Newline to purchase the power AC adapter for powering external devices. Please do not connect any products which require power than listed. Doing so may cause injury or damage to the panel.

## 1.4 Front Buttons



Buttons	Operations	Functions
	Short press	Power on • Solid white color : Display is on and working.
		Power off • Solid red color : Display is in shut down mode.
	Short press	Open the Settings menu.
	Long press for 3 seconds	Open the Source application.
	Short press	Go to the home page.
	Long press for 3 seconds	Turn on/off the power button lock function.
	Short press	Adjust the Brightness.
	Long press for 3 seconds	Turn on/off screen freeze.
	Short press	Adjust the Volume.
	Long press for 3 seconds	Enable or disable the touch function. Notes: When the touch function is disabled, the Android system, external sources and multi-user channels will be in no-touch mode. If you tap the screen, it will display “The touch function is locked!” .

### Note













- Press **Volume + >Volume + >Volume - >Volume - > Left > Left > Right > Right** buttons on the Remote control to turn on/off the touch function.
- The power button on the front panel will be locked if you activate the power button lock. Long press  button for 3 seconds to exit the lock.

## 1.5 Remote Control

### CAUTION

Carefully read the following instructions before using the remote control to avoid possible faults:





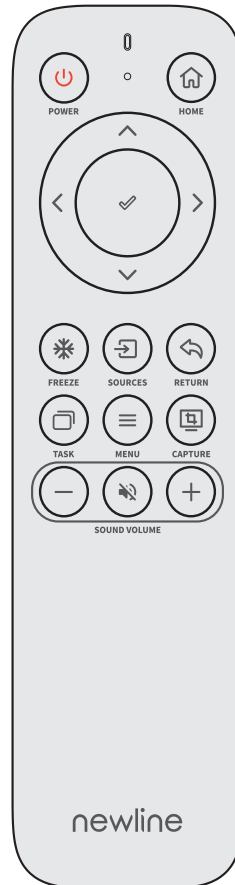









- Do not drop or damage the remote control.
- Do not spill water or other liquids on the remote control.
- Do not place the remote control on a wet object.
- Do not place the remote control directly under sunlight or near a heat source.







Buttons	Operations
	Power On/Off
	Go to the Home Page
	Directional Pad
	Confirm/OK
	Press once to freeze the current screen. Press again to exit freeze function
	Enter the Source Selection Page
	Return to Previous/Exit
	App switcher
	Open the Settings menu on the embedded operating system.
	Take a Screenshot
	Press once to decrease the volume, long press to decrease the volume continuously
	Mute/Unmute Audio
	Press once to increase the volume, long press to increase the volume continuously



## 1.6 AI Remote Control (Optional)

An AI remote control is a remote control device integrated with artificial intelligence technology. Compared with traditional remote controls, an AI remote control can be operated via voice commands to realize intelligent control of devices. Works with voice assistants. Please refer to AI remote control's User Manual for specific usage instructions.

Buttons	Operations
	Power your Newline panel on/off
	Press arrows to navigate around display
OK	Confirm selection or "left click" when in air mouse mode
	Press and hold the microphone button. Once the LED indicator light turns green, the remote is able to receive voice commands.
	Press AI button to make an intelligent conversation with AI
	Press to enable/disable air mouse mode
	Increase or decrease the panel's volume
	Enable or disable the mute function on your Newline panel
	Increase or decrease the panel's brightness
	Return to previous page
	Return to your Newline panel's home screen
	Open the task switcher (all open apps) on your Newline panel
	Open the "Sources" menu and switch inputs.
	Open the settings menu on your Newline panel
	Press to enable the Freeze function on your Newline panel. Press again to unfreeze your Newline panel's screen.

Buttons	Operations
	User can assign a function to this button.
	User can assign a function to this button.
	User can assign a function to this button.
	Open your Newline panel's application list.
	Take a screenshot, then access the "Save and/or Share" function.
	Open the panel's native Screen Recording application.



# 2

# Installation Guide

## 2.1 Safety Precautions

### • Installation Environment



### • Installation Direction

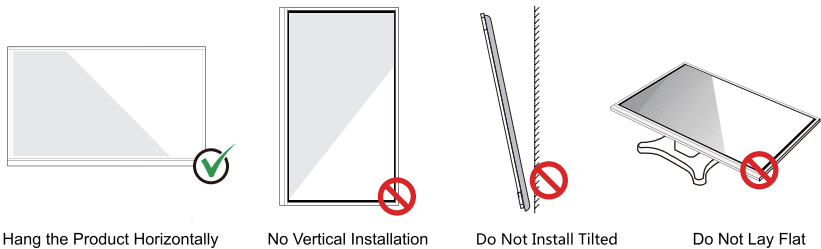

## 2.2 Installation Precautions

### • Weight Loading

Weight of the product:	55 inch: 28 kg/61.7 lb.	65 inch: 33.5 kg/73.9 lb.
	75 inch: 44.5 kg/98.11 lb.	86 inch: 59.5 kg/131.17 lb.
	98 inch: 105 kg/231.49 lb.	

- When using a mobile stand, ensure that the weight of the product is less than the loading capacity of the mobile stand.

- When using the wall-mount bracket, ensure that the wall can support the weight of the product. We recommend that the wall surface be reinforced and have a loading capacity 4 times of the weight of the product. Consult a professional installer for wall-mount installation.
- Attaching the VESA Mounting Bracket. This apparatus is intended to be supported by a GS Listed wall-mount bracket.

**Note**

The company does not undertake relevant legal responsibility for any problems caused by improper operation if the third party mobile stand, or wall-mount bracket is beyond the scope of the product.

- Do not install the product where it might be hit by an opening or closing door.

**Vertical installation**

When installing the panel, try to keep the panel vertical. An excessive tilt angle may cause damage to the glass or other internal components.

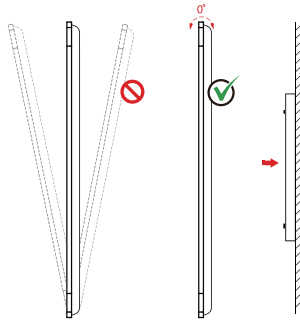

**Note**

For any problem, please contact our support desk. Our company is not responsible for any damage or losses incurred by users if the users fails to follow the instructions.

**Ventilation**

Ensure adequate ventilation and/or an air conditioned environment. We recommend keeping certain distances from the side of the product to the wall or panels. Ventilation requirements are shown in following figure:

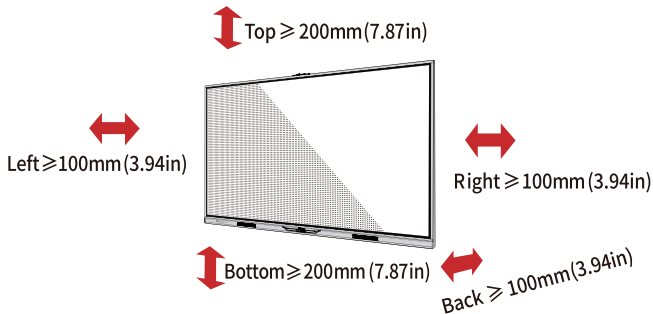

## 2.3 Installation

The dimensions of the four bracket mounting holes on the back panel are VESA MIS-F compliant:

55 inch: 400 x 400 mm/15.75 x 15.75 in.

65 inch: 600 x 400 mm/23.62 x 15.75 in;

86 inch or 75 inch: 800 x 400 mm/31.50 x 15.75 in;

98 inch: 800 x 600 mm/31.50 x 23.62 in;

Use metric M8 screws with a length of 10 mm to 15 mm (0.40 to 0.59 in) to secure the touchscreen to the mounting system. Dimensions of the mounting holes on the back panel are shown on the following figure:

### Note

Consult a professional installer to install the display product.

55"

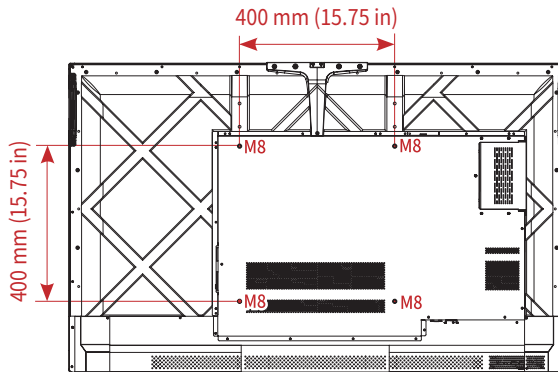

65"

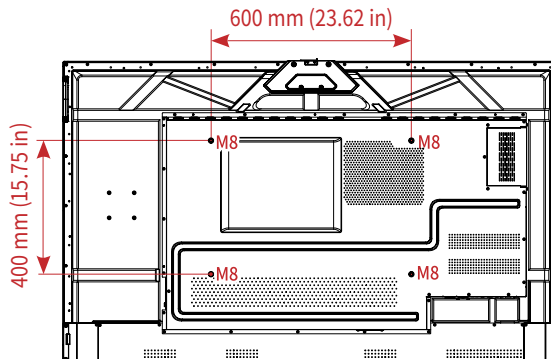

75"/86"

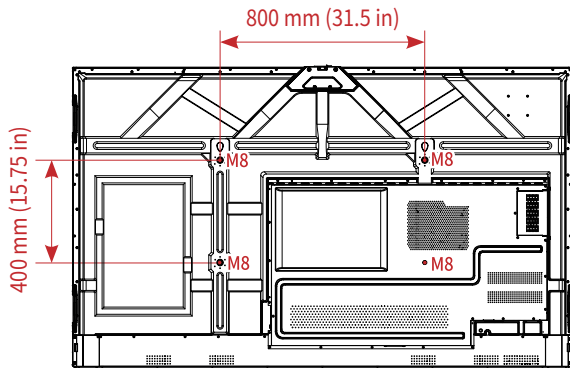

98"

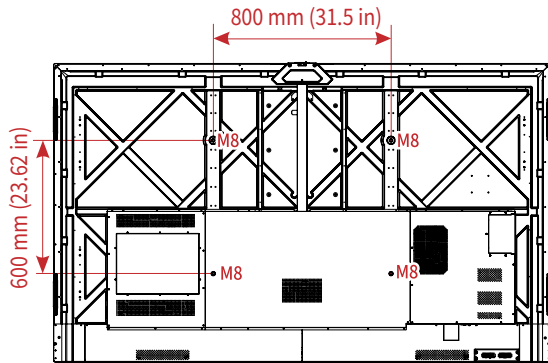

## 2.4 Installing the OPS (Optional)

### CAUTION

The OPS does not support hot plugging. Therefore, you must insert or remove the OPS when the display is powered off. Otherwise, the display or OPS may be damaged.

You will need to purchase the OPS separately. Perform the following steps to install the OPS.

Step 1: Unscrew the M4 screws by hand to remove the OPS protective cover.

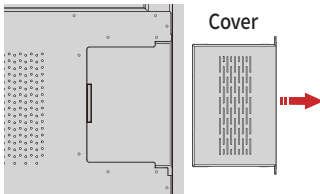

Step 2: Push the OPS into the OPS port on the rear of the panel until firmly seated, using the M4 screws to secure the OPS.

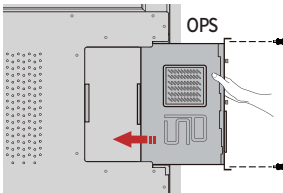

## 2.5 Installing the Camera(Optional)

The camera is put in accessory box with an independent package, please install it onto panel referring to following steps. Use two screws along with the camera to fix it.

Remove the silicone cover from the middle port on the top of the panel display, then insert the camera. Install 2 fixing screws for secure purpose. Remove the front cover and start using.

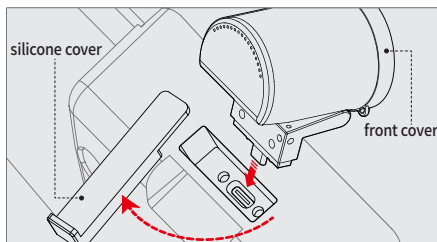

## 2.6 Installing Newline Assistant

### 2.6.1 Introduction

The Newline Assistant agent is a tool used as a bridge between the embedded operating system and the OPS. It helps add Windows software shortcut to the Home Page, as well as to protect USB data when switching between sources.

Therefore we strongly recommend users install the Newline Assistant after installing the OPS.

### 2.6.2 Installation

**Step 1** Install select the OPS correctly (See "Installing the OPS (Optional)").

**Step 2** On the **Home Page**, tap **OPS** and the source will switch to the Windows operating system.

**Step 3** Visit our website at [www.newline-interactive.com](http://www.newline-interactive.com) and choose **Products > Q Ultra series > download** to download the Newline Assistant installation package.

**Step 4** Install the [Newline Assistant](#) as instructed.

# 3

## Getting Started

### 3.1 Power On

Step 1: Ensure the power cable is fully seated into the panel and wall outlet before powering on the panel. Please confirm your wall outlet supports a power range of 100V to 240V with frequency at 50 Hz/60 Hz  $\pm$  5% and is fully grounded.

#### Note

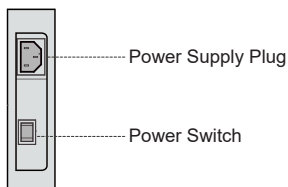

The power outlet should be installed near the equipment and should be easily accessible.

Step 2: Flip the power switch located on the side of the product to "I".



Step 3: Press the power button  on the front control panel or  on the remote control.

### 3.2 Power Off

Step 1: Press the power button  on the front panel or the power button  on the remote control and a **Warning** dialog box will be displayed as shown in the following figure.

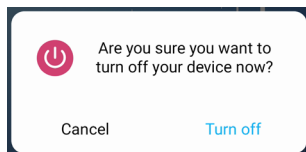

Step 2: In the **Warning** dialog box, tap **Cancel** to return to working mode. Tap **Turn off** to turn off the panel, and the power indicator will turn to red.

Step 3: If you want to completely turn off the panel, turn off the rocker switch behind the panel (next to the power socket) and unplug the power cord.

### Note

- If an OPS is installed, the OPS and the screen will simultaneously powered off when the power is shutoff.
- Please properly shut down the panel before disconnecting the power source or it may cause damage. Accidental power failure may cause damage to the panel.
- Do not repeatedly turn the power on & off in a short period of time as it may cause malfunction.

## 3.3 Calibration

If the cursor position has a big deviation from the actual touch point, calibration is used to eliminate the deviation. Calibration is required in the following scenarios:

- The OPS is used.
- A computer is connected through the HDMI or Display Port interface.

### Note

Interface operation on the embedded operating system does not need positioning. External products with Microsoft Windows 7 or later versions will require positioning.

If the positioning is not correct, perform the following operations to calibrate again. The following takes Windows 10 as an example:

- Step 1: Ensure that the HDMI or DP interface and external products are connected properly.
- Step 2: Select the corresponding Windows signal from the signal source menu. The Windows page will be displayed.
- Step 3: Select **Tablet PC Settings** on the **Control Panel** page.

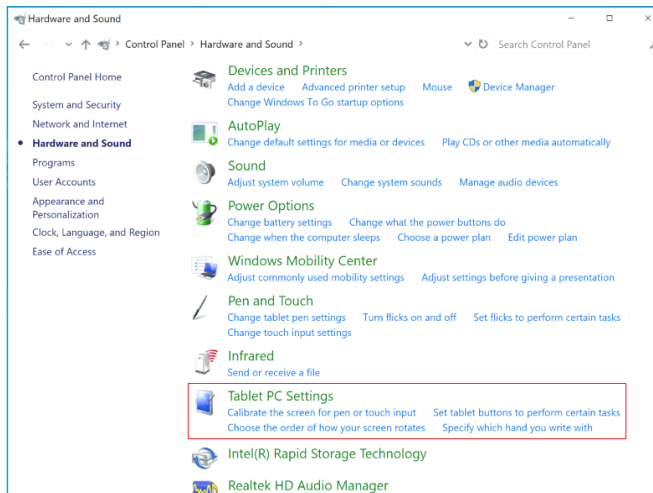

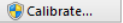
Step 4: Select “  ” in the Tablet PC Settings window.

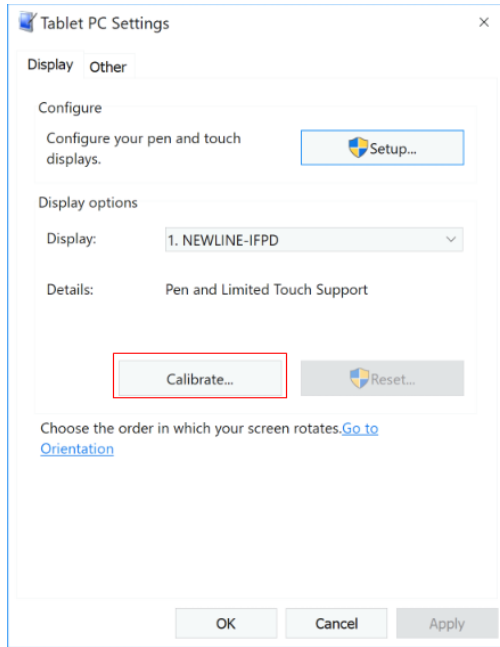

Step 5: Select **Touch input** from the option and start calibration.

Step 6: Use your finger or a pencil to click and hold the center of the flickering cross + . Do not release until + moves to the next positioning point. Complete the calibration process as instructed.

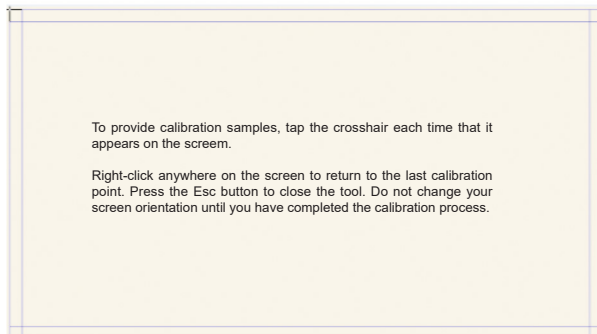

Step 7: After the calibration is complete, the **Digitizer Calibration Tool** dialog box will be displayed. Click **Yes** to save calibration data.

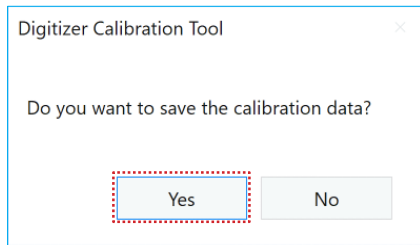

 **TIP**

- To ensure writing accuracy, use the pencil or stylus included with the product for proper positioning.
- Positioning errors may cause failure of touch functions of the display. In that case, please perform calibration again.

Step 8: The **Tablet PC Settings** dialog box will be displayed again. Tap **OK**. The calibration will be complete.

# 4

# Operating

## 4.1 Profile Login

When you set the screen lock in **Settings>Security & privacy>Set a screen Lock**, you need to verify the lock screen code after each boot.

Method	Operation
Swipe	Swipe the screen to unlock
Pattern	Draw an unlock pattern, the pattern need connect at least 4 dots.
Pin	Enter the PIN, the PIN can be 4 ~16 digits.
Password	Enter the password, the password can be the combination of letters, numbers and symbols.
QR Code	Scan the QR code to unlock

### Notes

After the screen lock is enabled, every time you boot up the screen, system will request the passkey.

If you forgot your passkey, please contact your administrator to reset your passkey.

## 4.2 Home

Once logged into the system, the user will be taken to the **Home** page as shown in the following figure.

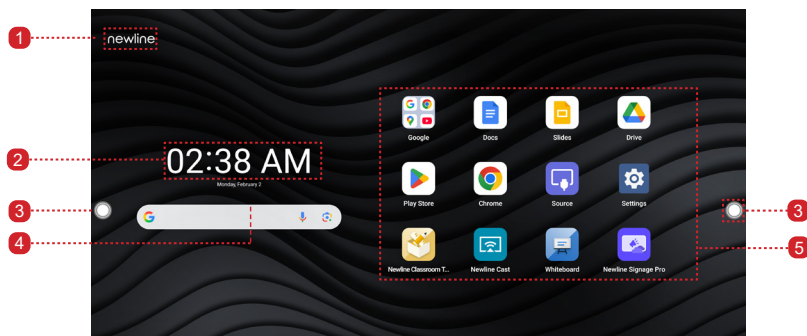



- 1 Logo
- 2 Clock & Date and Week
- 3 Toolbar
- 4 Google Search Bar
- 5 Application

## • Gestures

Gesture	Functions
Slide Up	Slide up to view all the applications.
Slide Down	Slide down to expand the quick setting menu.
Slide Right	Slide right to enter the google login interface.

## • Home button

Icon	Functions
	Return to the previous menu or exit an app.
	Back to the home page.
	Enter the task management.

### Notes







You can enter **Settings > System > Gestures > System navigation** to set the button.



## • Toolbar

OPS, Home, Annotation Mode, Whiteboard, Quick access bar, Dashboard, Task manager and Return icons are displayed by default in the toolbar on both sides of the screen.

You may hide toolbar in the Settings or move it on the screen, shrink or expand by using touch gestures.

The functions of the toolbar are as follows:

Icon	Functions
	Tap to switch to the OPS source, long press to customize the icon.
	Go to Home page.
	Tap once to start annotation mode, tap again to stop annotation and take a screenshot.
	Switch to whiteboard mode.
	Minimize or maximize the toolbar.
	Tap to enter the quick access bar.

Icon	Functions
	Tap to enter the Dashboard.
	App switcher allows the user to manage currently running applications. Swipe left or right to view currently running applications, swipe up or down to close the application or tap “clear all” to close all the applications.
	Return to the previous menu or exit an app.

### Shrink and Expand:

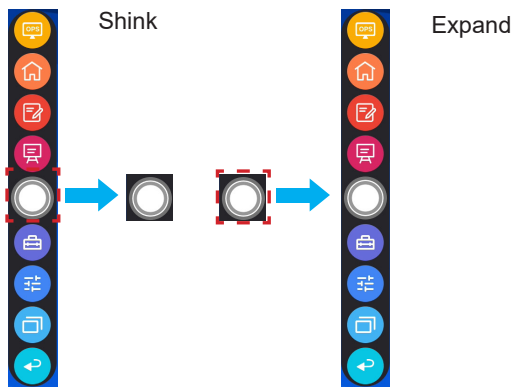

### Quick Access Bar

In the quick access bar, system preset some common apps. Tap the app icon to access the application interface. Tap the touch disable icon to turn on/off the touch function.

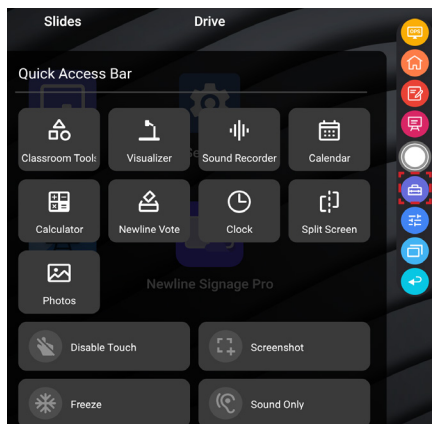

**Dashboard:**

Menu	Functions
Sound	<ol style="list-style-type: none"> <li>Option includes standard, meeting, classroom, custom mode, standard mode is default;</li> <li>After selecting customization, the interface displays bass, treble and balance, and the default values are all 50.</li> </ol>
Image	<ol style="list-style-type: none"> <li>Includes three modes: Image Mode, Color Temp, and Backlight Mode.</li> <li>Image mode includes five options: Standard, Vivid, Soft, Auto-Contrast, and Custom. Color temp includes three options: Standard, Warm, and Cool. Backlight mode includes five options: Eco, Standard, Auto, Eco+, and Custom.</li> <li>Click Customize to display the image Settings, including brightness, contrast, hue, saturation and sharpness Settings. The default values are all 50 except for sharpness, which is 10.</li> </ol>

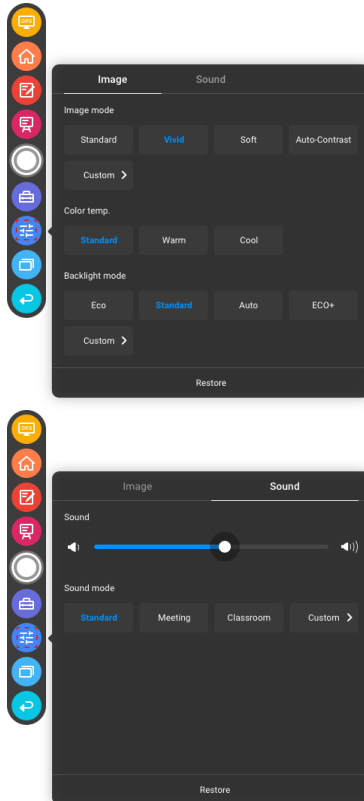

**Toolbar > Compass floating bar**

Press the toolbar and drag it out, the toolbar can be transformed into a Compass floating bar.

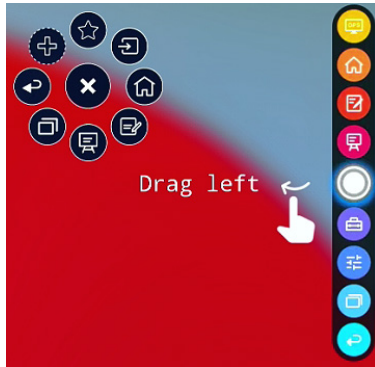

### Compass floating bar > Toolbar

Drag the floating bar to the edge of the screen, the Compass floating bar can be back to the toolbar.

In the floating bar, users can tap the icon to enter function interface, add and delete icons, add custom icons, drag the tool bar with their fingers to move around on the screen.

### Standard > Minimized

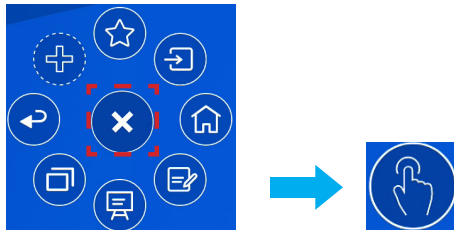

### Standard > Favorite

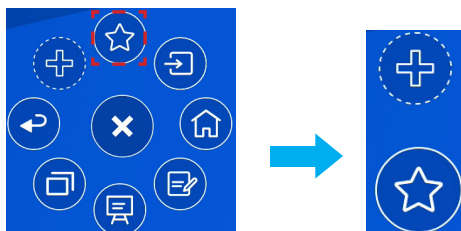

## Delete icons

Long press the icons to enter the icon deleting status, tap the × icon on the upper left corner to delete icons.

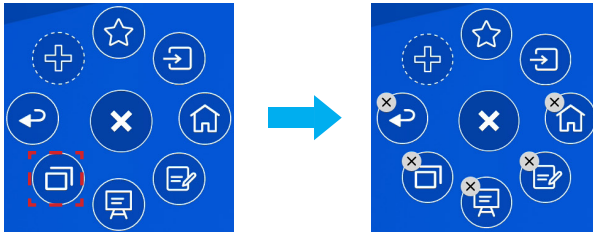

## Signal source

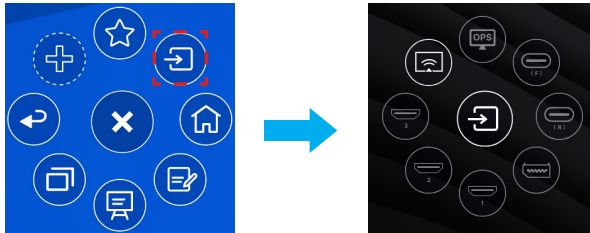

## 4.3 Whiteboard

The whiteboard function is designed to present conference writing to attendees in a quick and easy manner. The whiteboard has the following functions:

- **Discussion and screen annotation**

On the whiteboard page, you can select pen type, width, and color to write or annotate on the screen. You can also erase selected content or clear all content on the screen.

- **Page navigation**

Preview or delete pages.

- **Palm rejection**

When Palm rejection is turned on, fingers and pen can write and draw, but palm and fist would not be recognized.

- **Palm eraser**

When Palm eraser is turned on, fingers and pens can also be recognized, and palm and fist will be recognized as large eraser.

### Note

The Palm Rejection and Palm eraser function are available for whiteboard and annotation application, both of which are mutually exclusive and cannot be turned off simultaneously. You can turn on/off Palm Rejection function on the whiteboard setting page.

## • Whiteboard Mode

- Tap **whiteboard** icon on the Home page or tap  on either side toolbar to enter the embedded whiteboard mode, as shown in the following figure:

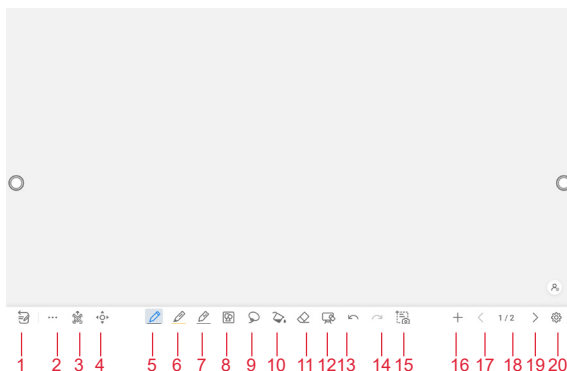

SN	Icon Name	Icon Function
1	Mode Switch	Tap to switch to annotation mode.
2	More	Tap to enter options interface. Users can insert image, Text, Sticky note, Search Image or Search Web etc.
3	QR Code	Tap to export the whiteboard data into QR Code.
4	Move Canvas	Tap to enter move canvas function, press and move your finger in the page to move canvas and content on it.
5	Pen	Tap to use the pen function, the icon turns blue. Tap the icon to set the pen size and color.
6	Highlighter	Tap to use the highlighter function, the icon turns blue. Tap the icon to set the highlighter size or color.
7	AI Pen	Tap to use the AI pen function, the icon turns blue. Tap the icon to set the color.
8	Insert Auto shape	Tap to enter the auto shape selection interface. Users can insert the shapes and set the shapes color.
9	Select	Tap to select and edit the whiteboard content. When an object is selected, users can move, zoom in/out, copy, cut, lock, change layer or delete object, etc.
10	Fill Tool	Supports single-click filling of closed areas and drag-and-fill of closed areas formed by connecting the start and end points of a drawn path.
11	Eraser	Tap to select the eraser function and the icon will turn blue. Tap the icon to set the way of eraser.
12	Clear	Clear all data on this page.
13	Undo	Back to the previous step.

SN	Icon Name	Icon Function
14	Redo	Tap to restore the action that was cancelled in the previous step.
15	Capture	Tap to take a screenshot.
16	New Page	Tap to add a new page.
17	Previous Page	Tap to back to the previous page.
18	Navigation	Tap to show the page thumbnails.
19	Next Page	Tap to go to the next page.
20	Settings	Tap to enter the whiteboard setting interface.

### 4.3.1 Whiteboard Functions

- **New Page and Settings**

- Create a new page

In discussion mode, tap **+** to create a new page. Up to 99 pages can be created. See the following figure:

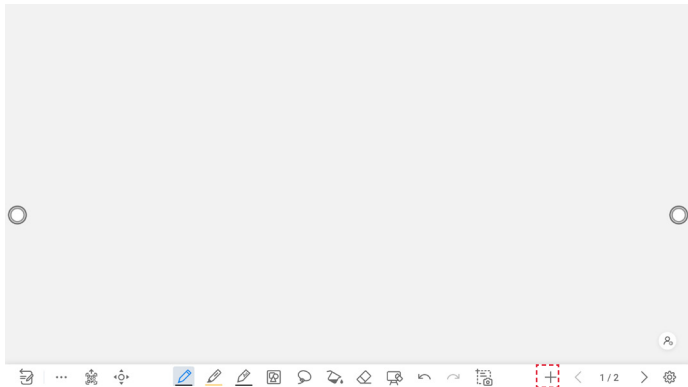

- Page settings

Press **+** to enter the background setting. Select the color and pattern and click **ADD** to add a new page. The set color and pattern will be displayed on the new page, as shown in the following figure.

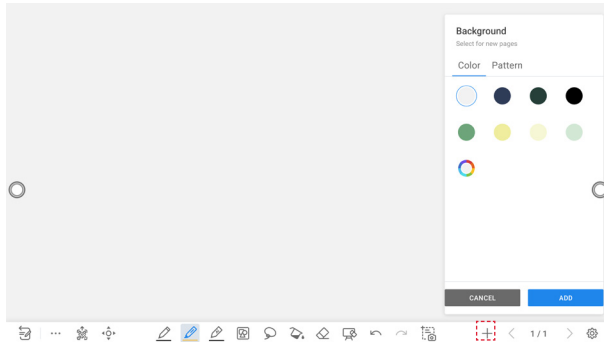

## • Mode Switch

Tap  in the lower left corner of the whiteboard mode to switch to annotation mode.

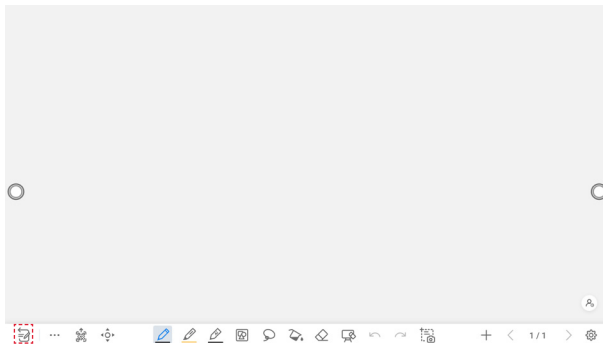

## • Options

Tap the  icon to enter options interface. Users can manage files, add Text, Sticky note, Search Image or Search Web etc.

On the **FILE** items, you can import data from file management, save whiteboard files and export the whiteboard page.

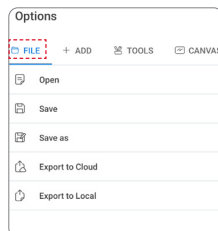

On the **ADD** items, you can import the images, Text, Sticky note, table, PDF document, concept map, Video, Audio from system files, USB, network. You also can import the Search Image, YouTube Video and Search Web in the internet.

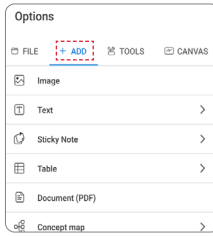

On the **TOOLS** items, you can use rulers to draw line or shape on the page, import the visualizer image etc.

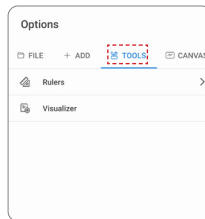

On the **CANVAS** items, you can choose split mode to set the split application.

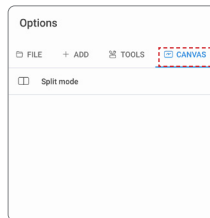

## • QR code export

On the Whiteboard, tap  to pop up QR code exporting windows. You can export the whiteboard page into QR Code, before that, you can customize the number of export page, change the export format at first.

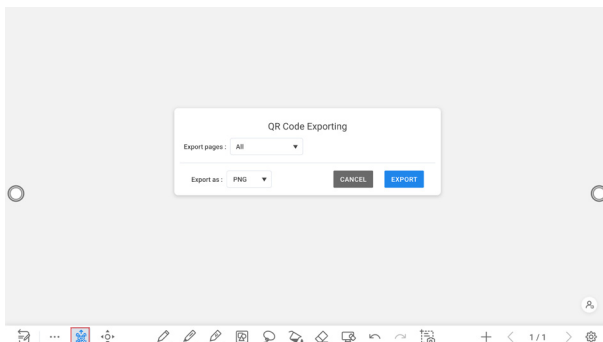





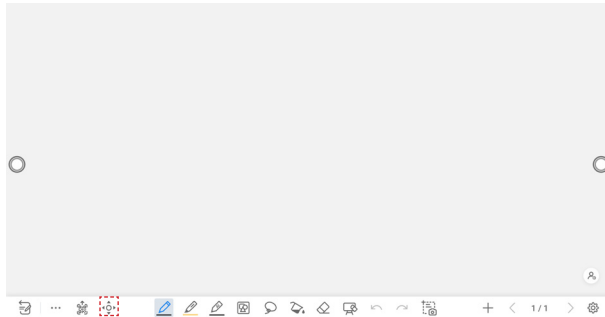

## • Move canvas

On the whiteboard, tap the icon to enter move canvas function, press and move your finger in the page to move canvas and content on it.



## • Pen Type

On the whiteboard, several types of pens are supported: hard pen, brush, Pressure-sensitive Pen, Laser Pen, Magic pen, highlighter and AI pen.

- Hard pen  and brush  : used to write.
- Pressure-sensitive pen  : used to write, varying line thickness based on detected pen movement speed.
- Laser pen  : used to write, the written content will disappear automatically after 3 seconds.
- Magic pen  : select one pattern to draw and customize the pattern.
- Highlighter  : used to highlight. Characters covered by comments are still visible.
- AI Pen  : used to write, support text recognition and shape recognition.

## • Line Size and Color

On the whiteboard, tap the pen icon to set the size and color. You can select the line size and color for writing, as shown in the following figure:

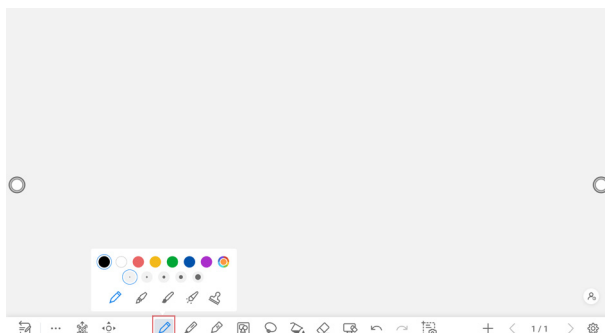

## • Insert auto shape

On the whiteboard, tap  to insert the shape or set the shapes and color. 2D and 3D

graphics are available.

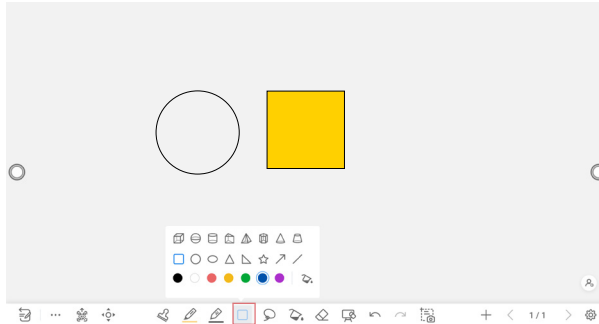

The  icon supports three status:

- Unavailable: The icon is unavailable when users insert arrow and line;
- Unselected: The edge of shapes are colored when the icon is not selected;
- Selected: the shape will be filled with colors when you import the shape.

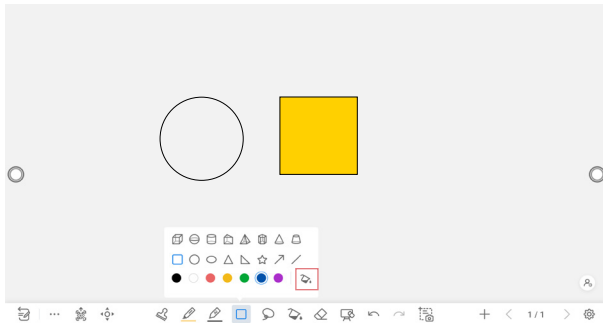

### • Select

On the Whiteboard, tap  and user could choose the data on the page to move/ zoom in/ zoom out/ rotate/change colors.

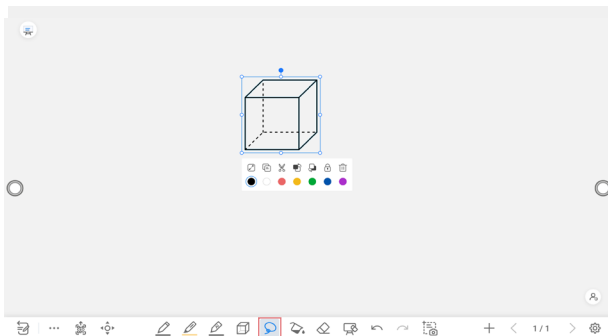

Rotate:

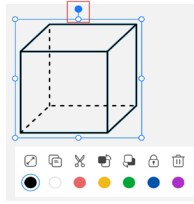

Zoom in/out:

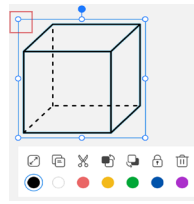

Icon	Functions
	Long press this icon to rotate the selected items.
	If a 3D shape is inserted, you can unfold it into a net when the shape is selected.
	Tap this icon to copy the items.
	Tap this icon to cut the items.
	Combine two or more selected objects into a single object.
	Break apart the combined object into its original components. (The icon will appear only after objects are combined)
	Tap this icon to push to top layer.
	Tap this icon to push to bottom layer.
	Tap this icon to lock the layer.
	Tap this icon to delete the items.
	Paste (Long press the screen around two seconds. The icon will appear only after one object copied or cut).
	Tap this icon to unlock the layer. (The icon will appear only after one object locked)
	Tap this icon to search web page.(The icon will appear only after select text or handwriting)
	Tap this icon to extract text from the picture. (The icon will appear only after select picture)
	Tap this icon to convert handwriting into text. (The icon will appear only after select handwriting)
	Tap this icon to access the AI search.

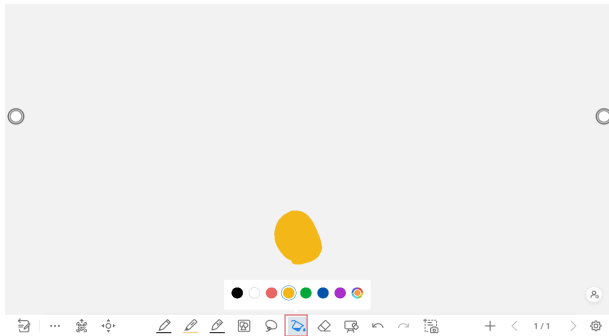

## • Fill Tool

Supports single-click to fill closed areas, and fill closed areas formed by connected start and end of drawn paths.



## • Eraser

Two methods are available to erase written errors or content as follows:

- Partial eraser: Tap  to clear the passing part of eraser.
- Object eraser: Tap  to clear the whole object.

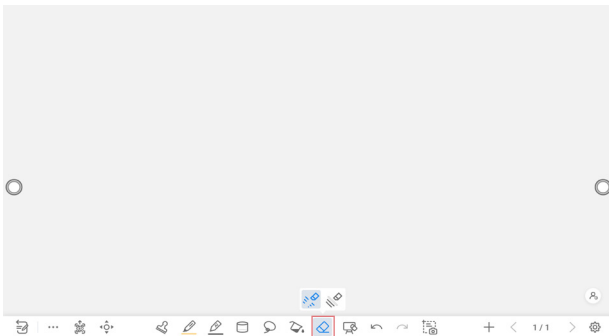

### Note



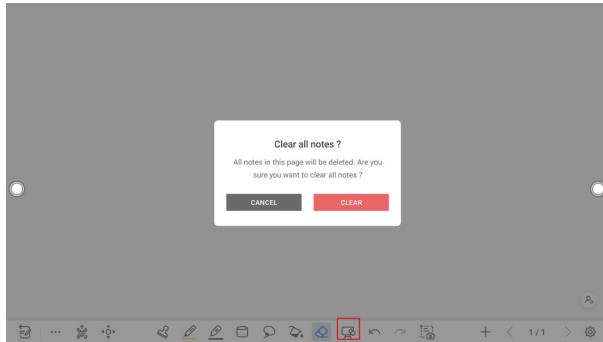

You can tap  to enter **Settings> Default settings>Eraser** to set the type of eraser.

## • Clear All

On the Whiteboard page, tap  to show the pop-up windows to clear all content on the current page, as shown in the following figure:



## • Capture

Tap  capture icon to take a screenshot, users can tap  whiteboard mode icon to switch to whiteboard mode; tap  save icon to save screenshot, tap  exit icon to exit screenshot.

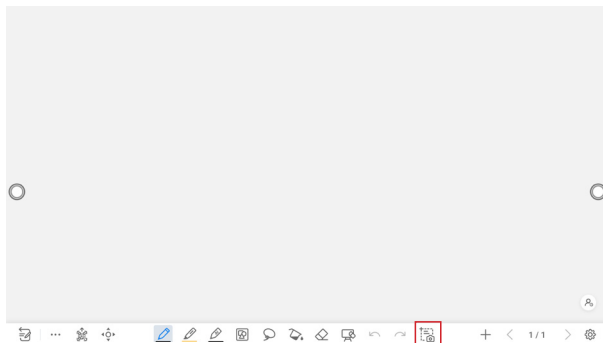

## 4.3.2 Whiteboard Setting

Tap the  icon to enter the settings bar, users can set the whiteboard mode, whiteboard mode switch button, object recognition, action hint, default settings and handwriting recognition.

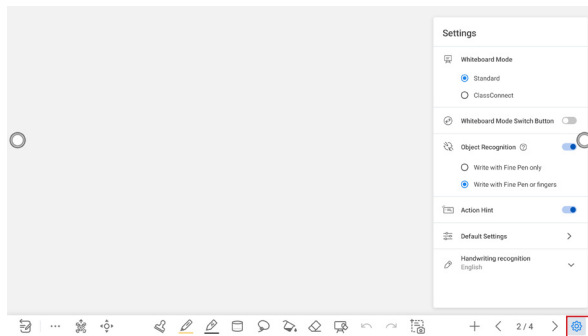

## • Whiteboard Mode

Whiteboard mode includes two modes: Standard and ClassConnect, with Standard Mode enabled by default. When ClassConnect is selected, the system will enter collaborative whiteboard mode.

## • Whiteboard Mode Switch Button

When this function is enabled, a “ClassConnect” shortcut icon appears in the upper-left corner of the whiteboard. Tap the icon to switch between Standard mode and ClassConnect mode.

## • Object recognition

Users can drag the slider to enable the object detection function, tap ⓘ icon to view details functions, as shown in the following figure:

Example 1: Turn on write with Fine Pen only

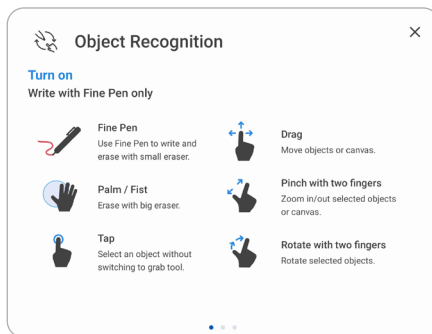

- Fine Pen : User Fine Pen to write and erase with small eraser.
- Fist/palm: Identified as an eraser.
- Tap: Select an object without switching to grab tool.
- Drag: Move objects or canvas.
- Pinch with two fingers: Zoom in/out selected objects or canvas.
- Rotate with two fingers: Rotate selected objects.

Example 2: Turn on write with Fine Pen or fingers

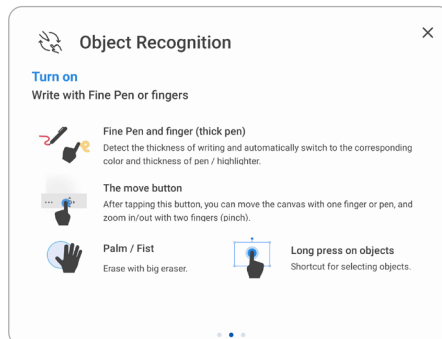

- Fine Pen and finger (thick pen): User Fine Pen or finger (thick pen) to write. System will detect the thickness of writing and automatically switch to the corresponding color and thickness of pen/highlighter.
- The move button: After tapping this button, you can move the canvas with one finger or pen, and zoom in/out with two fingers (pinch).
- Palm/Fist: Erase with big eraser.
- Long press on objects: Shortcut for selecting objects.

Example 3: Turn off object recognition

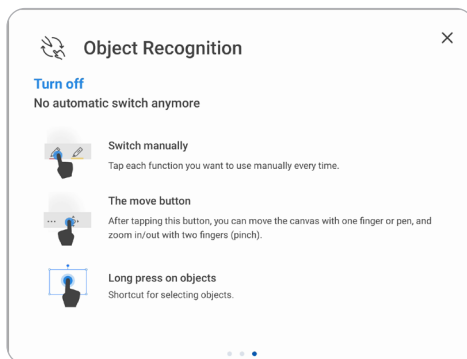

- Switch manually: Tap each function you want to use manually every time.
- The move button: After tapping this button, you can move the canvas with one finger or pen, and zoom in/out with two fingers (pinch).
- Long press on objects: shortcut for selecting objects.

**Action hint:** Drag the slider to enable the action hint.

**Default settings:** Tap the button to enter the default setting page, any new page will use the default settings. Users can set whiteboard page background, change the color and thickness of Smooth Pen and Highlighter, change the default type of eraser, both object eraser and partial eraser can be set.

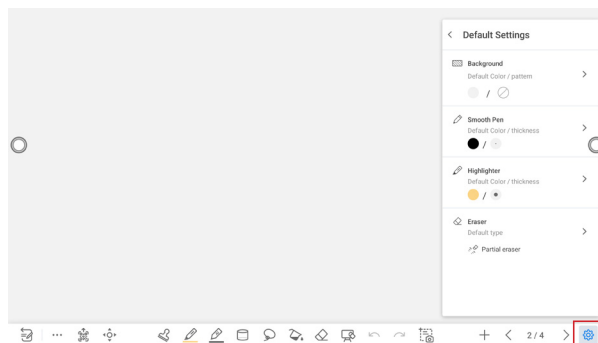

**Handwriting recognition:** Tap to select the language for handwriting recognition.

### 4.3.3 Page Operations

You can preview, select, and delete the writing page, you also can save the page to the USB Flash device or local files.

#### • Page Preview

Tap **1 / 1** at the lower right corner in the whiteboard mode. All pages will be displayed. Tap one page to switch to that page for more operations, as shown in the following figure.

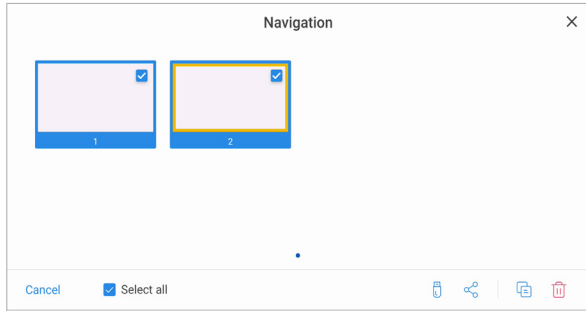





#### 📖 Note

Only 8 pages are displayed at once. You can slide right or left using one finger to see more.

#### • Page Operation

On the **Navigation** page, you can select or delete writing pages according to requirements, as shown in the following figure:

- Tap  to select all pages.
- Tap  to save the writing pages to USB flash device.
- Tap  to share the writing pages to local file or AquaMail.
- Tap  to copy the page.
- Tap  to delete selected pages.

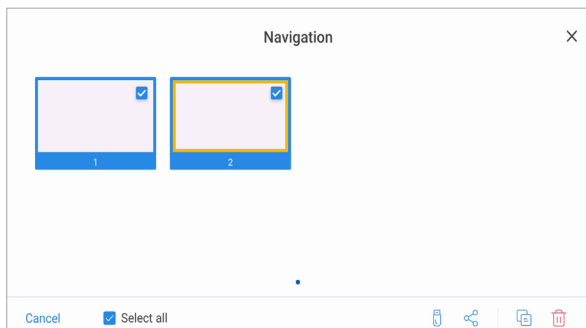

### 4.3.4 ClassConnect

ClassConnect is designed to streamline remote whiteboard interactions. Users can create a classroom session. After attendee join via QR code or URL link, the teacher's writing and drawing on the whiteboard will be displayed in real time on the viewer's end.

Step 1 On the whiteboard settings page, select **ClassConnect** mode.

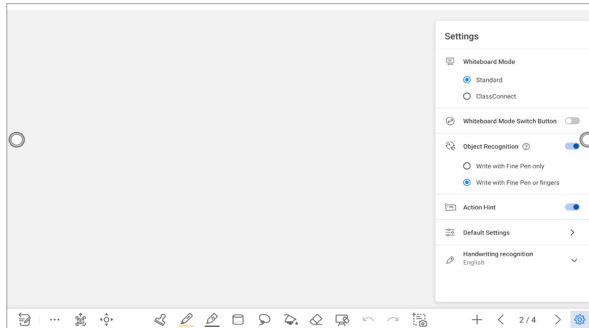

Step 2 Tap the Share to start class; tap Next to automatically generate the Class ID, web link, and QR Code.

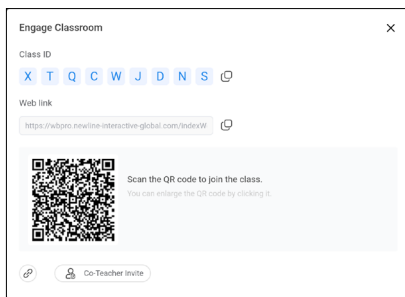
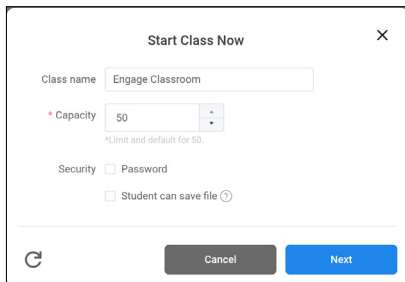

Step 3 Attendees can join the class via a web browser or by scanning a QR code through a third-party app, where they will see the whiteboard page shared in real time by the teacher.

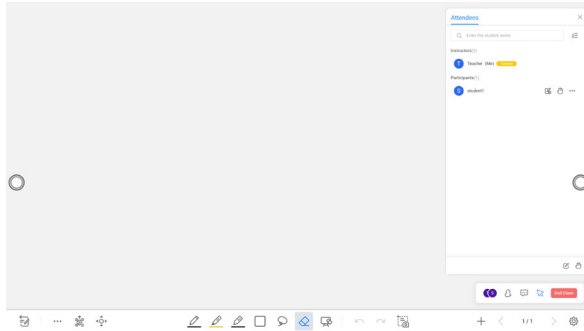

Step 4 The teacher console can set permissions and remove participants from the attendee list.



### 4.3.5 Annotation

In annotation mode, the system generates a transparent layer at the top of the screen, and users can add annotations to the transparent layer until the annotation mode is exited.

The user can enter the annotation mode through the following two methods:



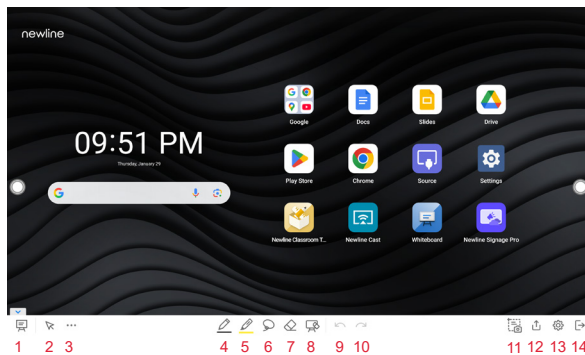

- Tap the “” icon in the toolbar;
- In the “**Whiteboard**” interface, tap the “” icon.



SN	Icon Name	Icon Function
1	Whiteboard	Tap to switch to whiteboard mode.
2	Mouse	Tap to return to the current interface from the annotation mode to control the application or interface.
3	Files	Tap to select PPT, PPTX and PDF format file to import into the annotation interface for annotation.

SN	Icon Name	Icon Function
4	Pen	Tap to use the pen function, tap again to set the size or color. And the chosen color and the size would be shown by the icon.
5	Highlighter	Tap to use the Highlighter function, tap again to set the size or color. And the chosen color and size would be shown by the icon.
6	Select	Tap to select and edit the whiteboard content. When the object is selected, users can move, zoom in/out, copy, cut, rotate, lock, change layer or delete object.
7	Eraser	Tap to enter the eraser function and the icon will turn blue. Tap again to set the way of eraser.
8	Clear	Clear all data on this page.
9	Undo	Back to the previous step.
10	Redo	Tap to restore the action that was cancelled in the previous step.
11	Screenshot	Tap to take a screenshot, you can customize the way of saving.
12	Save	Tap to enter the navigation page, you can select and save the page to the USB Flash device or local files.
13	Setting	Tap to enter the annotation setting interface.
14	Close	Tap to exit the annotation mode.



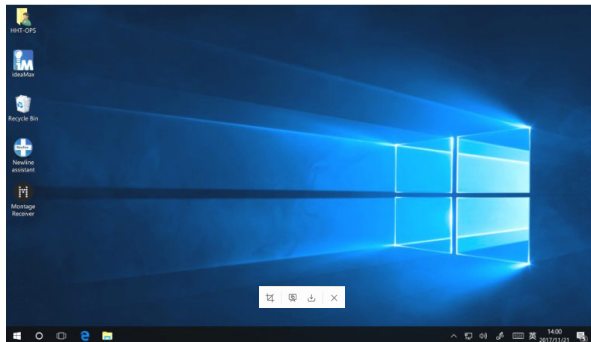

## • Take a Screenshot

Tap  icon to enter take a screenshot interface, users can tap  icon to take a screenshot; tap  icon to switch to whiteboard mode; tap  icon to save screenshot, tap  icon to exit screenshot.



## • Save screenshot

Tap  icon to pop up settings interface, you can save or share screenshot as following:

- Tap  to select all pages.
- Tap  to view tips.
- Tap  to save the annotation pages to USB flash device.
- Tap  to share the annotation pages to local file or AquaMail.

### Note

You can enter **Files > images > image** folder to view or get screenshots.

## • Settings

Tap  settings icon to pop up settings interface, you can turn on/off object recognition, Action hint, Auto screenshot and switch to Float Annotation Mode.

If Auto Screenshot setting is on, system will automatic take a screenshot when exiting the annotation mode.

If Float Annotation Mode is on, the annotation toolbar will always be displayed at the top of the page. The floating toolbar can be dragged and collapsed.



### Note

If you need more details instruction, please refer to whiteboard setting.

## 4.4 Application

On the Home page, slide up to view all applications. The following figure shows applications that the system is delivered with.

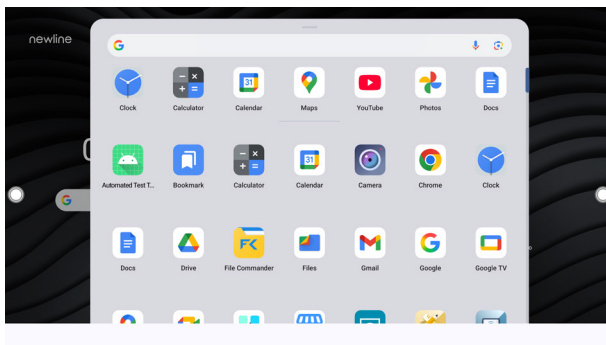

### 4.4.1 Google Play Store

Enter the Google App Store, you can install apps as you need, enter my apps to uninstall the applications.

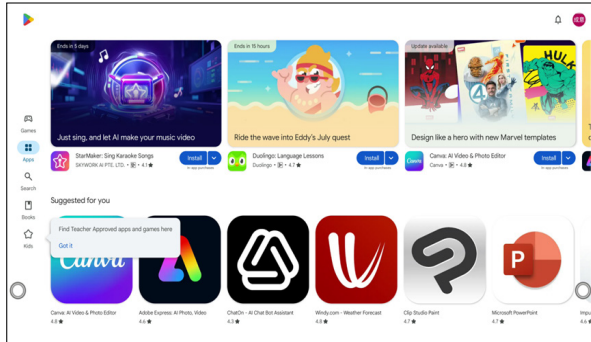

### Note

Before installing an application, ensure that the installation lock is closed.

## 4.4.2 Newline display management+

Newline Display Management Plus is a remote display management solution that enables users to centrally manage the Newline displays from the comfort of their desk. Users can deploy and install apps, configure display settings, and push updates without communicating back and forth.

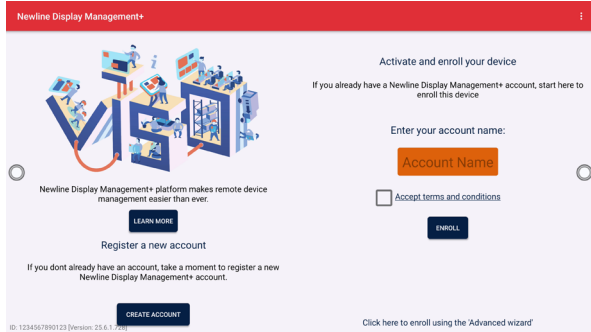

### Note

Please visit our website at [www.newline-interactive.com](http://www.newline-interactive.com) and enter **Product > software solutions** to get more details about Newline Cast and Newline Display Management.

## 4.4.3 Newline Cast

Multiple devices can be cast wirelessly to the display through several casting modes (Airplay, Google Cast...). To cast: tap Screen Sharing on the Home Page to enter Newline Cast. On screen directions will appear for you to follow in order to wirelessly cast to the display, as shown in the following figure:

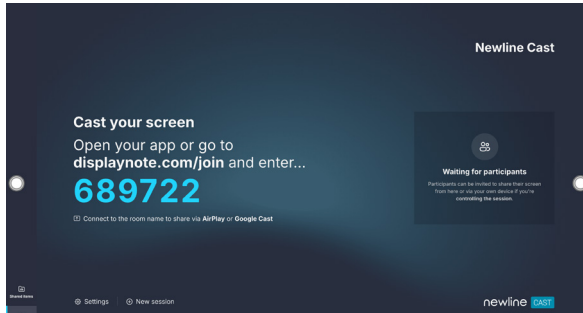

### 4.4.4 Newline Signage Pro

Newline Signage Pro is an advanced digital signage software designed to make content management and deployment simple and efficient. Newline Signage Pro provides a complete digital signage solution for schools and businesses.



### 4.4.5 Newline Classroom Tools

The Classroom Tools widget is active in the background until the teacher needs it. As an overlay, the teacher opens the tools menu even after navigating between screens. This cuts down transition time and the number of devices needed throughout the day such as a timer, stopwatch, and more.

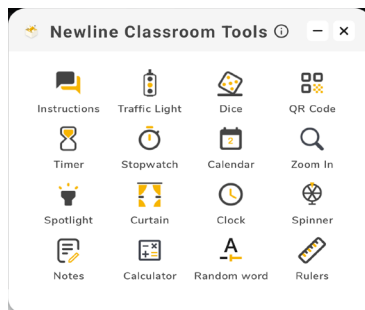

## • Windows Minimization

Tap  to minimize the window into a floating icon on the screen. Tap again to expand when needed.



## • Exit

Tap  to exit classroom tools. The Warning dialog box will be displayed as shown in the following figure.

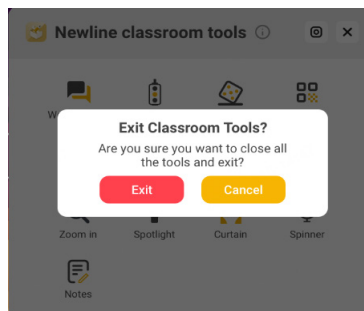

## • Instrucions

Tap  to enter instructions page. You can see six different picture indicators: Ask neighbor, Work together, Silence, Share ideas, Any questions and Raise hand. Tap any image to enlarge it. Tap again to return it to its original size.

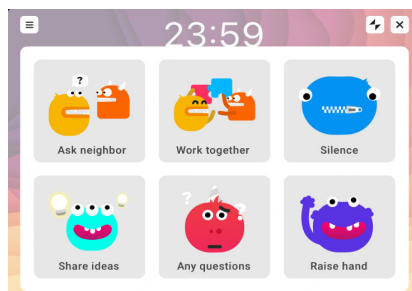



## • Traffic Light

Tap  to enter traffic light page. Tap any one color of the traffic light, the currently selected color will be highlighted to indicate its active state. As shown in the following figure.



## • Dice

Tap  to enter dice tool. Tap  to increase dice count or tap  to decrease it. Up to 6 dice can be added. Tap **Roll** to start shaking. Tap again to stop after a 3-second countdown.

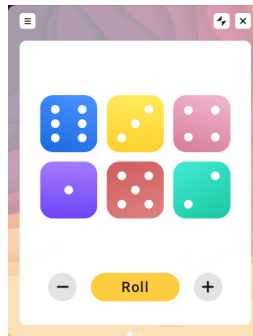





## • QR Code

Tap  to enter QR Code. You can type or paste a URL to automatically generate a QR code.





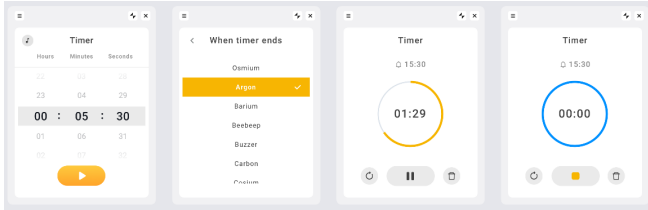

## • Timer

Tap  to enter timer. Tap  to start the timer. During timing, tap  to pause the timer; tap  to reset the time or tap  to delete current timer. You can customize the timer and sound.



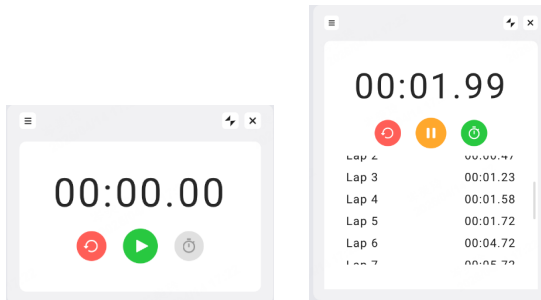

## • Stopwatch

Tap  to enter stopwatch. Tap  to start the stopwatch. After stopwatch starts, this icon turns yellow , and simultaneously the right icon turns green , allowing you to record the current time. Tap  on the left to reset.





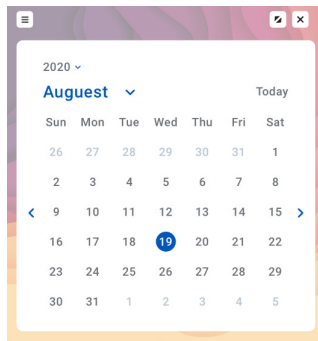

## • Calendar

Tap  to enter calendar and view the current month. In the calendar, the date with a blue background is today. You can select the year and month to view other dates. Tap  to switch to the previous month; tap  to switch to the next month.



## • Zoom in

Tap  to enter zoom in mode. Tap  to scale up the current page proportionally. Tap  to scale down the current page proportionally. Tap  to reset the current page to original size. Tap  to exit the zoom in mode.

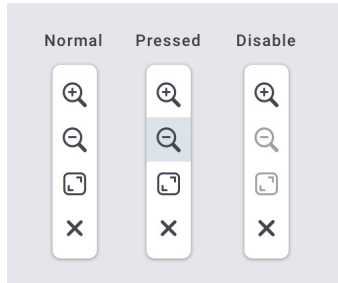

## • Spotlight

Tap  to enter spotlight mode. The spotlight focuses learners' attention on a specific screen area, improving teaching effectiveness.

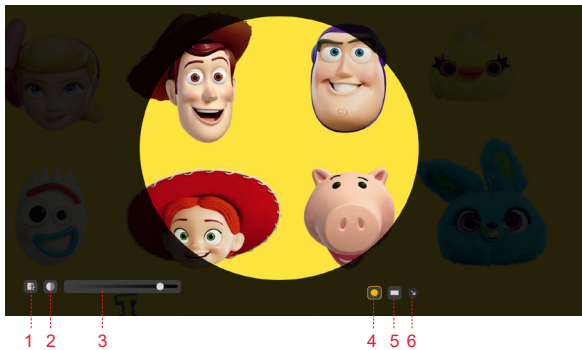

SN	Function
1	Tap to exit spotlight mode and return to main menu.
2	Tap to collapse the adjustment box.
3	Tap and drag to set background transparency.
4	Select circular spotlight.
5	Select square spotlight.
6	Tap and drag to adjust the spotlight aperture size.



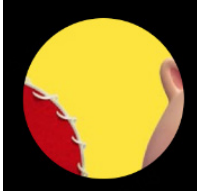

Tap and drag anywhere within the spotlight aperture to move it.

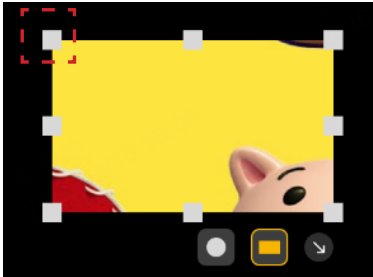

The square's size can be adjusted freely.



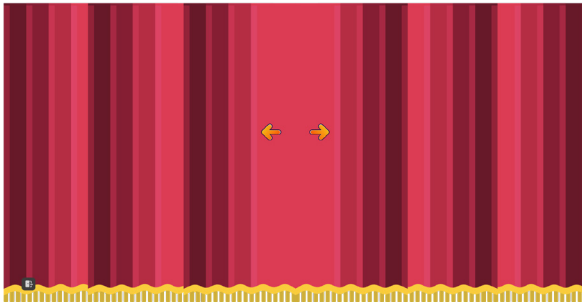

## • Curtain

Tap  to enter curtain mode. Tap  or , and the curtain will expand outward from the center line to both sides until it is fully opened. Tap  to exit the curtain mode.



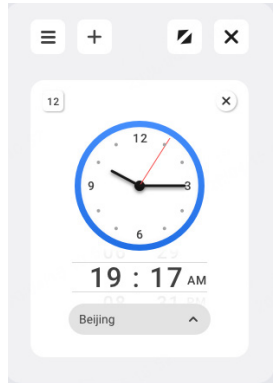

## • Clock

Tap  to enter clock and the default time follows the device's time zone. Tap  to add a clock; tap  inside the clock widget to delete a clock. Tap the **12** in the upper-left corner to switch to 24-hour display. Tap below to select a time zone as needed.





## • Spinner

Tap  to enter spinner mode. Tap + to add an option, or tap – to delete one. Up to 15 options can be added. The default options are Fruit, Number, and Letter. You can choose one of them as the initial default value.

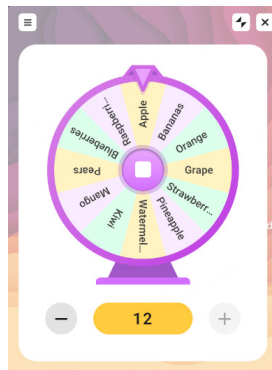
Tap  to start spinning. It will stop automatically after 4 seconds. Tap again before 4 seconds to stop it immediately. Press and hold the text to edit the characters.



## • Notes

Tap  to enter notes mode. By default, one title and three summaries. Tap + to add summary. Up to 20 summaries can be added. Handwriting or text input is supported for adding a summary. Once the summary is added, tap  to scan a QR code to get the notes.

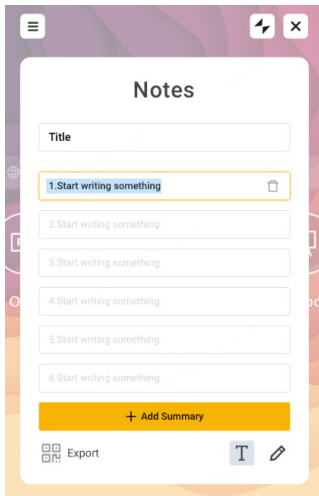

## • Calculator

Tap  to open the calculator.



## • Random word

Tap  to open random word generator.

- Number of words: Set the number of words to generate. Up to 99 words can be generated.
- Word type: All, Nouns, Verbs, Adjectives, Extended.
- First letter: Optional, can be left blank. Restricts the first letter.

- Last letter: Optional, can be left blank. Restricts the last letter.
- Word size by: To specify the word size, you can use the Syllables option or the Letters option. The Syllables option restricts words by syllable count, with options for equals, greater than, or less than a given number. The Letters option restricts words by letter count, with the same set of options.
- Generate: Generate results based on the above settings.
- Reset: Reset the data.

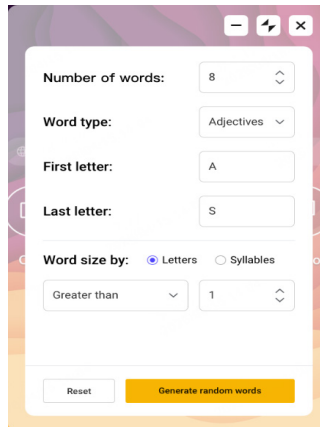

## • Rulers

Tap  to open rulers. You can select a ruler as shown in the figure below. The ruler is for measurement only and cannot be used for drawing.

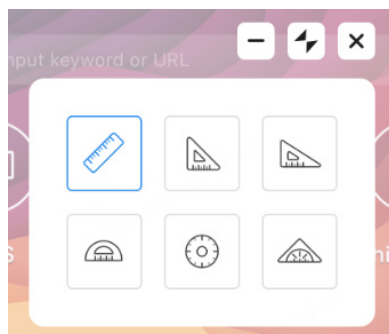

## • Mood meter

Tap **Go** to start the mood meter and generate a QR code.

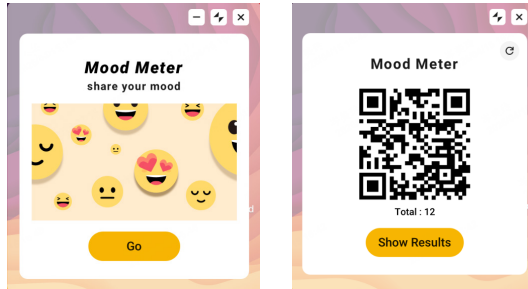

Scan the QR code with a mobile device to display the mood level. Then drag the slider to a mood and tap confirm. And the QR code on the IFPD allows users to view the total in real time.



After students submit their mood, tap **Show Results** on the IFPD to view the result. The results are shown as a pie chart with statistical values. The Show Results button is grayed out when no one has submitted a mood result.

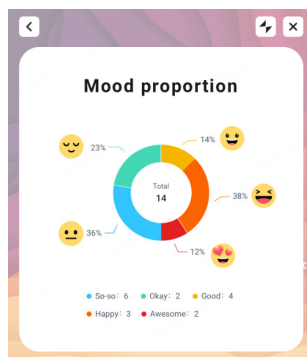

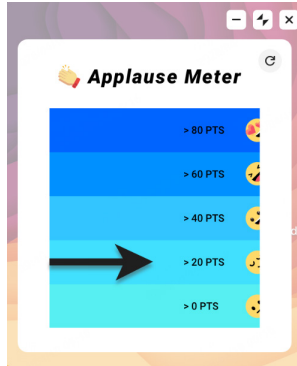

- **Applause Meter**

Open the applause meter. The applause detector measures the on-site volume in decibels and displays the real-time decibel value, helping users objectively assess the intensity of the audience's response. Tap  reset the arrow indicator.



- **Sticky note**

The sticky note opens with a yellow background by default. You can tap  to change the background color. Tap  to change text size. Tap  to save the sticky note as a picture to a local file.

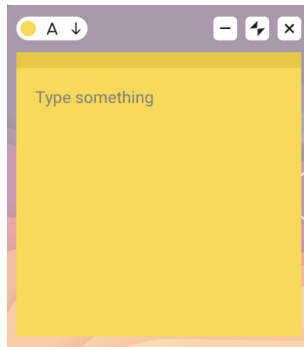

- **Random team**

The random group generator is designed to group a specified list of names. Tap + to add item or tap - to delete item. After finishing adding items, set the number of groups as needed. The number of groups cannot exceed the number of items. Tap Randomize to create groups. Tap Return to regroup.

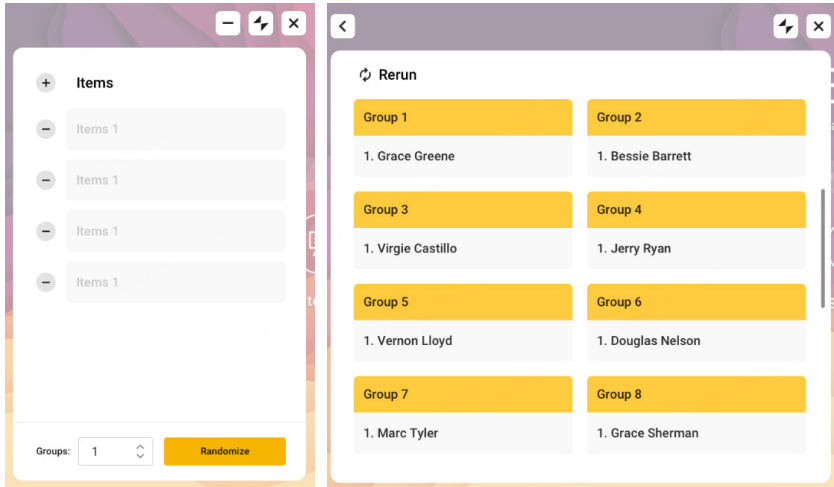

## • Weather

Open the weather widget. By default, the weather display follows the device's location. Both Fahrenheit and Celsius are available as temperature unit options. You can also search for a country, city, or street in the search box. Tap a result to jump to the weather page for that location.



## 4.4.6 Newline Secure

Newline Secure is a Common Alerting Protocol (CAP) integration software that offers robust security alerting capabilities, enabling organizations to receive and process CAP messages from third-party security platforms.

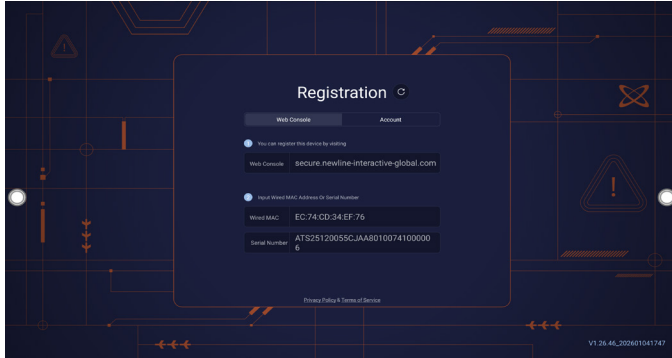

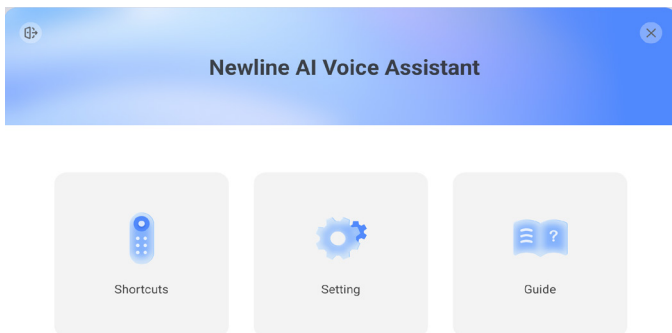

## 4.4.7 Voice Assistant

Newline Voice Assistant is a software that enables users to adjust settings for Newline AI Remote Control, an optional accessories that allows user to control IFPD via voice command. More efficient, more convenient.



## 4.4.8 Files

The product supports connection to USB flash memory. In Files application, you can preview all files in the internal storage and storage devices connected via USB ports.

Functions	Instruction
File Preview	Tap the submenu on the left side to preview recent files, images, videos, audio, documents and downloads files, files on the external storage devices connected via the USB ports.
File Search	Tap  and enter the keywords in the search box. The system will display a list of files that match the searched for keywords.
File Filtering	Tap  on the upper right corner to choose the file sorted by name or modified.
File Operation	Tap  on the upper right corner to select, copy, paste, delete, move and share the files.

#### 4.4.9 Visualizer

This product supports the use of external visualizer, after the visualizer is connected, tap the “” icon to access the visualizer application.



SN	Icon Name	Icon Function
1	Annotation	Tap to enter annotation mode.
2	Whiteboard	Tap to enter whiteboard mode.
3	Screen Display	Tap to display the visualizer camera.
4	Screen Split Mode (2)	Tap to display in 2 split screen mode.
5	Screen Split Mode (4)	Tap to display in 4 split screen mode.

SN	Icon Name	Icon Function
6	Camera Switch	Tap to switched the camera on back and forth.
7	Capture	Tap to take a screenshot, you can paste the screenshot on whiteboard, save it to files, save it to USB or Share it.
8	Rotation (Clockwise direction)	Rotate the camera image by clockwise direction.
9	Rotation (Counter-Clockwise direction)	Rotate the camera image by counter-clockwise direction.
10	Adjustment	Tap to adjust the brightness, contrast, saturation, sharpness.
11	Setting	Tap to set image mode, resolution, color system.
12	Exit	Tap to exit the visualizer.
13	Insert	Tap to capture or inset image from the files.

#### 4.4.10 Vote

Tap the “” icon on the Application program to enter “Vote”:

Users can input a topic (not required) and input options (2 options minimum, 10 options maximum). After tapping “**Complete**”, a QR code is generated for users to scan with their mobile devices.

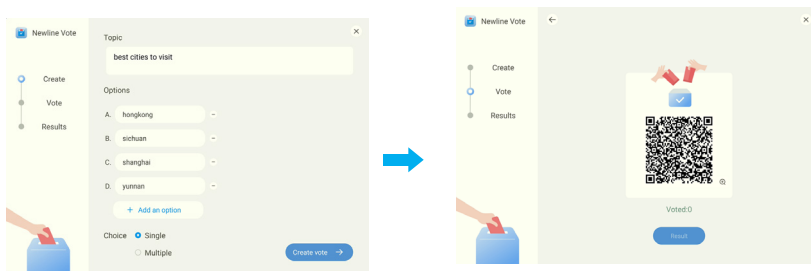

#### Note

“Vote” only works when both the panel and the mobile device are connected to the internet.

User will see the voting topic and options on the mobile device after the QR code is scanned. After making the selection, tap “submit” to cast vote.

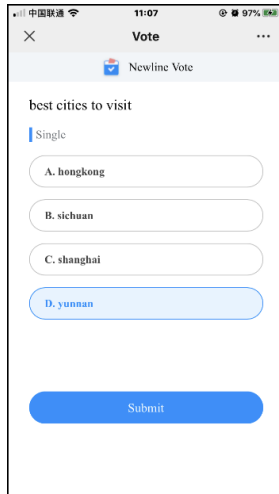

In the voting process, the number of voters is displayed in real-time under the QR code. Users can tap **“Result”** button to terminate the current vote process and show the voting results. The voting results can be displayed in the **“Pie chart”** or **“Bar chart”** form.

Users can tap **Insert into whiteboard** to insert the current voting results into the whiteboard.

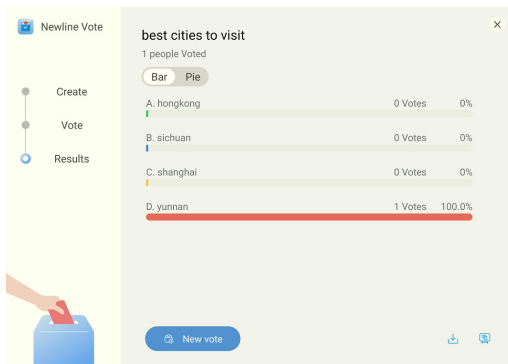

#### 4.4.11 Reminders

Reminders is a tool for recording, reminding, and tracking personal to-do tasks.

Tap **+ Add Task** to add a new task.

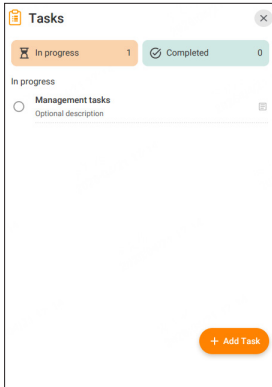

Users can set a title, add remarks and enable the reminders. The title is limited to 64 characters, which means it is a long text. When enabling the **Remind me** function, users can set a reminder time.

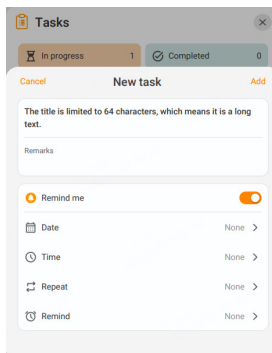

The reminder can be set to repeat, with options including none, every day, week and month. Default is None. Users can also set the remind, with options including on time, 5 minutes early, 30 minutes early, 1 hour early and 1 day early.

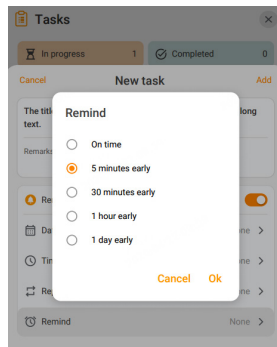
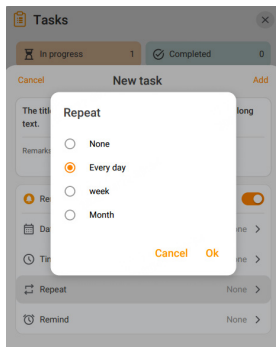

Newly added tasks will appear in the In progress list. Clicking the checkbox will set this task as completed and will not be reminded again.

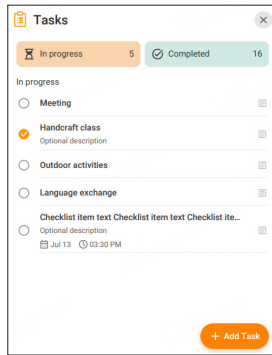

Completed tasks are moved to the Completed list. If unchecked, they are moved back to the In progress list.

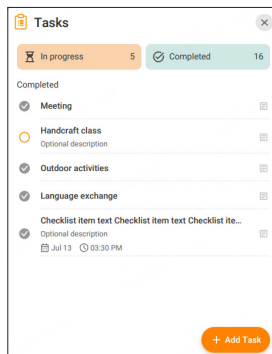

Swipe left on the task to display **Edit** and **Delete** options. Tap **Edit** to modify the task details, or tap **Delete** to remove it.

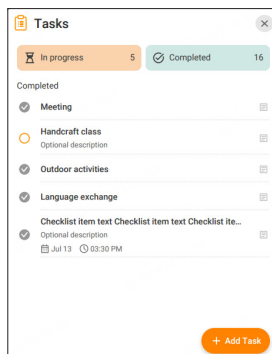

After the time is up, a reminder notification will pop up on the screen. Tap **Done** will end this reminder, tap **Remind me later** will remind you again in 10 minutes.

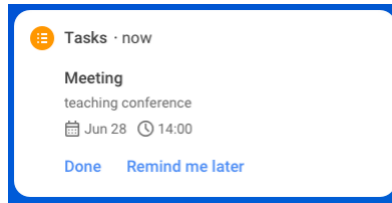

## 4.4.12 Newline App Store

Enter the Newline App Store, you can install apps as you need, enter app manager to uninstall the applications.

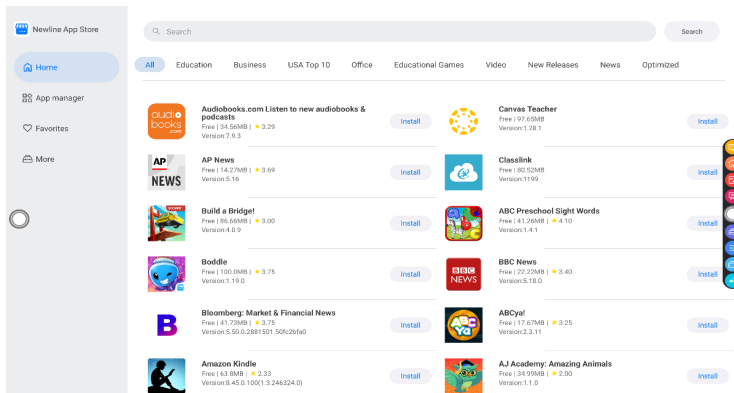

### Note

- Before installing an application, ensure that the installation lock is closed.
- Not all apps are supported for the 26Q series.

## 4.4.13 File Management

The product supports connection to USB flash memory. In File Viewer application, you can preview all files in the internal storage and storage devices connected via USB ports and select, copy, paste, delete and search for files.

### 4.4.13.1 File Viewer Page

On the **Home** page, tap **File Viewer** to enter file commander interface, you can tap the icon to view pictures or files, as shown in the following figure:

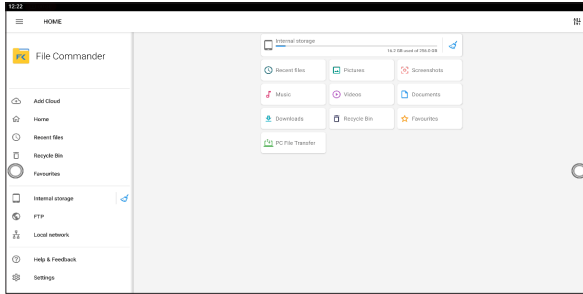



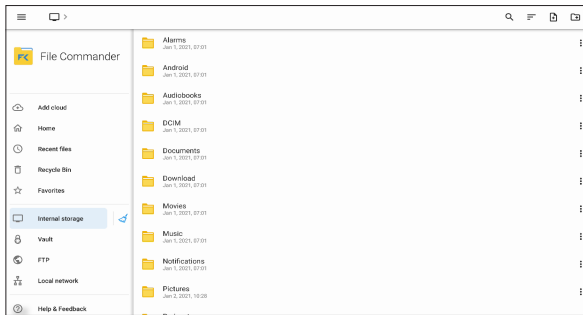

### 4.4.13.2 File Preview

Using the File Viewer application, you can tap the submenu on the left side to preview what files are on internal storage, external storage devices connected via the USB ports, cloud stored files, FTP uploaded files, and local network files, as shown in the following figure.





### 4.4.13.3 File Filtering

You can tap the menu on the left side to display files by type, for example, whether the files is a document, a picture, music, a video, archived or was downloaded.

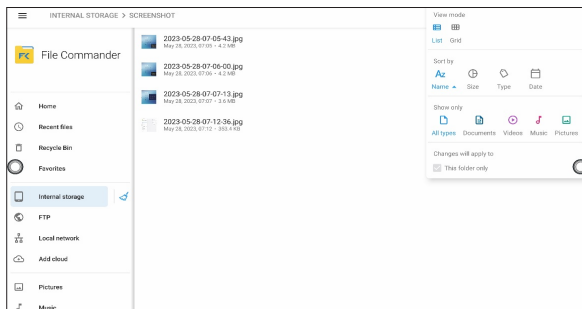
- The system supports two view modes: list and grid. You can tap  filter icon on the top right corner to switch  list icon or  grid icon view modes.
- Tap  filter icon to display files based on name, type, size, and modification.



#### 4.4.13.4 New Folder

Enter the **File Viewer** application, and tap  create file icon to create new file or tap  create folder icon to create new folder, as shown in the following figure.

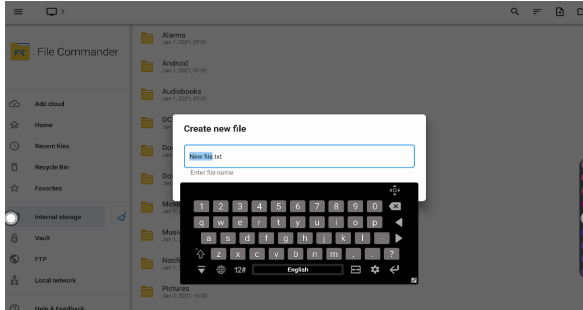

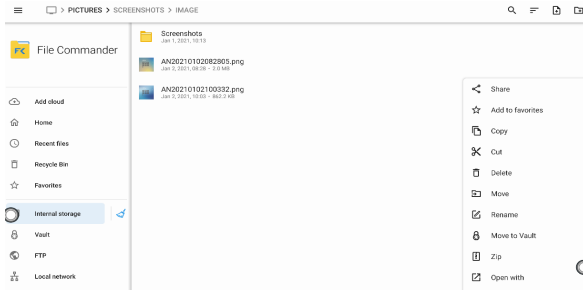

#### 4.4.13.5 File Operation

Enter the File Viewer application. You can create folders according to requirements, select files by long pressing, and set wallpaper/copy/paste/delete. For details on other operation, tap  in the upper right corner for more operation.



### 4.5 Extended Functions

Functions	Status	Operation
Sound Only	After entering the sound only mode, the screen was extinguished and the sound played normally.	<p><b>Turn on</b></p> <p>1 Tap the Sound only icon in the quick setting menu. (You can add items manually in the quick settings menu.)</p> <p>2 Tap the Sound only icon in the quick access bar.</p> <p>Note:</p> <p>After enabling Sound Only Mode, only the power, volume and mute buttons of the remote control can be used.</p> <p><b>Turn off</b></p> <p>Tap anywhere on the screen.</p>

Functions	Status	Operation
Child lock	When the function is turned on, the child lock icon will appear in the upper right corner of the screen, and the power button functions will fail.	<p><b>Turn on</b> Long press the  button on the front button for 3 seconds.</p> <p><b>Turn off</b> Long press the  button on the front button to exit the lock.</p>
Sleep	Enter the sleep state, the screen and backlight are off, the Android system and OPS are running normally	<p><b>Turn on</b> Press the power button.</p> <p>Note: Need to define the function of the Power button as Sleep in the settings.</p> <p><b>Turn off</b></p> <ol style="list-style-type: none"> <li>1 Press the power button to wake up</li> <li>2 Touch wake-up</li> <li>3 Access source wake-up</li> </ol>
Freeze	After entering the freeze screen mode, the freeze screen icon appears in the upper right corner of the screen	<p><b>Turn on</b></p> <ol style="list-style-type: none"> <li>1 Press the freeze button on the remote control;</li> <li>2 Tap the freeze icon in the Quick Settings menu;</li> <li>3 Tap the freeze icon in the Quick access bar;</li> <li>4 Long press the front brightness key 3s to lock screen freeze.</li> </ol> <p><b>Turn off</b></p> <ol style="list-style-type: none"> <li>1 Long press the front brightness key 3s to unlock screen freeze;</li> <li>2 Press the freeze button on the remote control.</li> </ol>

## 4.5.1 Capture

Using the screenshot function, you can capture the current page and save it in the form of a picture. You can enter the screenshot by the following way:

- Press the capture icon on the remote control;
- Tap the screenshot icon on the Quick access bar;
- Tap the save icon on the annotation page.

Common functions

- Freedom: Select the free mode, you can freely drag the screenshot box to adjust the screenshot screen;
- Full screen: Select full screen mode, full screen capture;
- Save: Click Save to get the screenshot and save it automatically;
- Insert: Take the screen capture as a picture and insert it into the whiteboard;
- Close: Exit screenshot mode.

Save screenshot



- Save to pictures: save the screenshot to pictures.
- Print: enter the print interface to print the screenshot.
- Bluetooth: share the screenshot by Bluetooth.
- Nearby share: share the screenshot by nearby share.
- Aqua mail: save the screenshot to Aqua mail.

## 4.5.2 Sources

On the Home page, tap  to enter the signal source selection, including OPS / Display Port / HDMI 1/ HDMI 2 / HDMI 3 /(F)Type C /(R) TYPE C/Newline Cast.

The icon without signal source connected is gray, and the icon with signal source connected is white. After you choose white icon, the content of the signal source can be displayed in the preview window for real-time preview.

You can enter sources interface by the following methods:

- Tap the  icon on the Home page;
- Tap the  icon on the remote control.



### Note





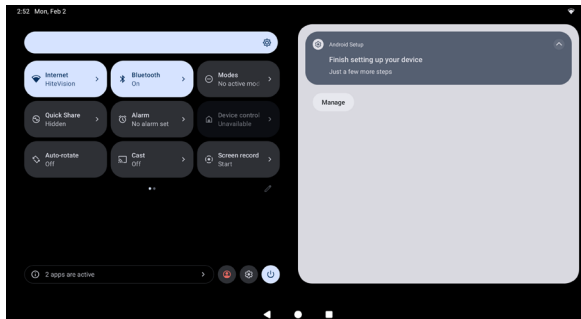











Enable the PIP function in **Newline Settings > Input & Output > Source PIP mode**.

## 4.5.3 Quick Setting Menu

Using fingers and swipe down from the top of the screen to access the Quick Settings menu, shortcuts are displayed on the left and notifications are displayed on the right, as shown in the following figure.



Icon	Functions
	Drag the slider to adjust the brightness.
	Tap to enter the setting of internet.
	Tap to enable or disable the Bluetooth.

Icon	Functions
	Tap to enable or disable the Do Not Disturb function or Bedtime.
	Tap to enter the Quick Share interface.
	Tap to enter the setting of Alarm.
	Tap to enable or disable the Device Control function.
	Tap to enable or disable the Auto-Rotate function.
	Tap to access the Cast application.
	Tap to access the Screen Record application.
	Tap to launch the QR code scanner.
	Tap to enable or disable the microphone access.
	Tap to enable or disable the camera access.
	Tap to enable or disable the toolbar left.
	Tap to enable or disable the toolbar right.
	Tap to edit the shortcut menu, hold and drag to add the items.
	Tap to enter the account selection interface, you can switch users, add user and guest.
	Tap to enter the settings page.
	Tap to select access to lockdown, power off and restart.

#### 4.5.4 Automatically Power Off



If the screen is left un-operated for a specified duration, it will automatically turn off.

Choose **Settings> Newline Settings> Power> Energy Saving** to set the duration. For details on the setting method, see "Power".

If it is operated again within specified duration, the screen is unlocked. Otherwise, the screen enters the power off mode.

## 4.6 Settings

Enter the system setting page using one of the following methods:

- Tap  on the **Home** page.
- In the **Quick Setting Menu**, tap the  icon.
- Press **MENU** button on the remote control.

### 4.6.1 Network & Internet

Enter the **Network&Internet** submenu to enable Wi-Fi or Ethernet, view network information, and enable the Wake on LAN function.

Menu	Setting	Functions
Internet	Ethernet	When the RJ45 port is properly connected to the network cable, tap the button to View the MAC address, IP address, gateway, subnet mask, and DNS information.
	Wi-Fi	Tap to enable the Wi-Fi function. Default is on, When both Ethernet and Wi-Fi are available, Ethernet is preferred.
	Network Preferences	Enable the Wi-Fi automatically turn on function; Enable the notify for public networks; Install the certificates as you need; Wi-Fi Direct.
Wake on LAN	ON/OFF	Tap the button to enable Wake on LAN function. Default is off, connecting the wired network can wake up the display.
Wake on Wireless LAN	ON/OFF	Tap the button to enable Wake on wireless LAN function. Default is off, connecting the wireless network can wake up the display.
IP Control	ON/OFF	IP Control uses the internet and Internet Protocol to transmit data and enable devices to communicate wirelessly.
Hotspot & tethering	Wi-Fi hotspot	Share a network through a Wi-Fi hotspot
	USB tethering	Share the network via USB
	Bluetooth tethering	Share the network via Bluetooth
	Ethernet tethering	Share the network via Ethernet.
Date Saver	ON/OFF	Enable the function to help reduce the data usage.
VPN	VPN	Configure the VPN and verify the CA certificate
Private DNS	ON/OFF	Tap to select DNS mode, off, automatic, private DNS provider hostname three modes are available

## 4.6.2 Newline Settings

Enter the **Newline Settings** to set Power, Sound, Input & Output, Display Option, Toolbar and Screen Eye Filters, Advanced and so on.

### 4.6.2.1 Power

Enter the **Power** submenu to set power on or power off as following:

Menu	Setting	Functions
Auto Power On	Switch ON/OFF	Tap to enable the function, users can set the power on time.
Power On Time	Set the time	Set the power on time, system will automatic power on at the customize time.
Auto Power Off	Switch ON/OFF	Tap to enable the function, users can set the power off time.
Power Off Time	Set the time	Set the power off time, system will automatic power off at the customize time.
Energy Saving	Set the frequency to shut down automatically	Set a duration after which the screen enters the countdown mode if the screen is left un-operated. After the screen is countdown, if the user does not operate the screen within 120s, the screen enters the power off mode. The duration can be set to <b>15mins, 30 mins, 60 mins, 90 mins, 120 mins</b> or <b>NEVER</b> . Default is NEVER. You can also customize this duration and the range is 3 minutes to 480 minutes.
Power Button Options	Sleep	Set the system enter sleep mode when users press power button.
	Power off	Set the system enter power off when users press power button.
Tap to wake screen	Switch ON/OFF	Tap to enable the function, users can touch the screen to wake up the system from sleep mode.
Signal Source Wake-up	Switch ON/OFF	Tap to enable the function, access signal source can wake up the display.

#### Note

**NEVER** indicates that the automatic power off mode function is not enabled.

### 4.6.2.2 Sound

Enter the **Sound** submenu to select the way of sound output.

Menu	Setting	Functions
Sound	Sound output selections	1.Speaker: Select this option, sound will come out of the IFPD speaker. 2.S/PDIF: Select this option, sound will come out of the device connected to S/PDIF port. 3.ARC: Select this option, sound will come out of the device connected to HDMI out (ARC) port. 4.Lineout: Select this option, sound will come out of the device connected to Line out port. 5.Mixed: Select this option, sound will be output from all four of these options simultaneously.
	Microphone input selections	All connected microphones can be selected, default: Auto
	Microphone reception range selection	The slider will only become adjustable when an external 4N22M device or available device is detected; otherwise, it will be grayed out or disabled. Settings take effect only after a restart. The default value is 15.

#### 4.6.2.3 Camera

Enter the camera submenu to enable or disable the camera. Options include None and detected external camera names.

- No external camera: Defaults to None.
- 1 external camera: Defaults to that device.
- 2 external cameras: Defaults to the first; select the other manually.

#### 4.6.2.4 Input & Output

Enter the **Input & Output** submenu to set the Home source, enable new input source and CEC auto.

Menu	Functions
Starting Source	Customize settings to connect to the signal source after power on.
New Input Source	Switch ON/OFF After the function is enabled, the system can automatically switch to the screen of the newly connected signal source.
CEC Auto Power On	CEC Auto Power On allows connected devices to turn on the power of the display.

Menu	Functions
CEC Auto Power Off	CEC Auto Power Off allows the display to turn off the power of the connected devices.
App auto-launch	Tap to select the app or a URL automatically running on startup, the app auto-launch only acts on Android system. 1. Default is None; 2. Only one Newline app can be selected at a time; 3. Enter the link, boot automatically jump to the URL.
HDMI 1/2 & DP EDID Switch 2.0	Tap to select the 1.4 and 2.0.
Source PIP Mode	Switch ON/OFF. When enabled, the source menu will switch to <b>PIP mode</b> for previewable signal sources.
Customize source name	Tap to customize source name.

#### 4.6.2.5 Display Option

Enter the **Display Options** submenu to select a theme (options include Google Theme, Newline Q Theme, and Newline Z Theme). You can also toggle the logo display on/off and configure the logo settings.

#### 4.6.2.6 Toolbar

Enter the **Toolbar** submenu to set whether to display the toolbar.

- Left: Tap to enable and disable the left toolbar.
- Right: Tap to enable and disable the right toolbar.

#### 4.6.2.7 Screen Eye Filters

Enter the **Screen Eye Filters** submenu to set **Writing Mode Filter**, **Brightness Mode Filter** and **Bluelight filter**. If the **Bluelight filter** setting is on, the **Filter level** can be set.

Menu	Setting	Functions
Writing Mode Filters	Switch ON/OFF	Tap to enable the function, the display will change whiteboard brightness under writing mode. Writing Mode Filters and Brightness Mode Filter are mutually exclusive and cannot be opened at the same time.
Brightness Mode Filter	Switch ON/OFF	Tap to enable the function, the display will change screen brightness based on ambient light,

Menu	Setting	Functions
Bluelight Filter	Switch ON/OFF	Tap to enable the function, the filter level tints your screen blue, this makes it easier to look at your screen or read in light.
Filter level	Set the filter level	Set the filter amplitude

### Note

Studies have shown that just as the ultra-violet rays can cause eye damage, the shortwave-length blue light rays from displays can cause eyestrain, retina damage, and affect vision over time. Newline Blue Light filter is an eye protection feature that can reduce the blue light. TT-5526QULT/ TT-6526QULT /TT-7526QULT /TT-8626QULT/TT-9826QULT has obtained this certification.

For protecting your eyes against prolonged display use, we highly recommend you to do the following:

- Let your eyes rest for 10 minutes after 2 hours of continues use.
- Roll your eyes upward towards your eyebrows, and then roll your eyes in a large circle every few hours.
- For every 20 minutes of display viewing, look into the distance for 20 seconds.
- When your eyes get sore, close your eyes for a minute.

### Using Low Blue Light

Decreasing the blue light emitting by the Interactive Flat panel display reduces the blue light exposure to your eyes.

The Interactive Flat panel display use a low blue light panel default setting mode, that when used in the default setting mode, is certified by TUV to reduce blue light output and create a more relaxing and less stimulating image while reading content on the screen.

The hardware solution was developed to control the blue light range emission. Instead of reducing the total blue range, the selected range reduction does not impact CCT and display color. It exposes users to less blue light emission while letting them enjoy good color on the display.

### Flicker Free

The flicker phenomenon is that the screen continues to alternate between light and dark, that is, the screen is constantly flickering. Some flicker phenomenon may not be perceived by the human eye, but the eye will still respond to the flicker of the screen (iris will expand and contract according to changes in brightness).

To improve this phenomenon, we use DC dimming technology to improve it, and obtained the flicker free certification.

## 4.6.2.8 Advanced

Enter 2364606633 to enter the **Advanced** submenu, you can set the System Update, Security, Enable Embedded OS, Modify Admin Mode password and Maximum volume.

Menu	Functions
System update	Upgrade options are as follows: OTA, over the air update method and automatic updates.
Security	Whiteboard and screenshot data removal frequency: you can set the time period of keep the data. When the set time is reached, the data is automatically cleared.
	<p>USB lock: When USB lock is enabled, USB devices will not be recognized.</p> <p>Notes: Once the USB lock function is turned on, it will be effective for owner, all users and guest. Whether the owner, user or guest enters the system, the USB lock function is always valid.</p>
	<p>Settings lock: When the setting lock is enabled, setting-related icons will appear locked. To adjust settings, you can unlock them in two ways:</p> <p>(1) Use the remote control to go to Settings and disable this option to unlock.</p> <ul style="list-style-type: none"> <li>•Press the Menu button on the remote control to enter Settings.</li> <li>•Use the remote control combination to enter Advanced: Up, Down, Up, Down, Left, Right, Left, Right, Volume +, Volume -.</li> </ul> <p>(2) Disable the settings lock via the remote control system.</p>
	Gadgets lock: All the installed application will be listed here, you can disable any gadgets you don't want to show in the gadgets list except whiteboard and settings.
	Installation lock: When you enable the Installation lock, under the smart system, you will not be able to install software through the app store or USB flash drive.
	Power button lock: When you enable the power button lock, the power button will be locked no matters on Android or any external sources.
	Front buttons lock: When you enable the front button lock, the front button will be locked no matters on Android or any external sources.
	URL Filtering: You can add URL links to block the access. This includes local browsers and all third party (user downloaded) browsers. Web search within the whiteboard will also be blocked.

Menu	Functions
	<p>Whiteboard AI Search: Tap to enable the AI search function on the whiteboard. Enable the Whiteboard AI Search via the remote control system.</p> <p>Frequency of clear Whiteboard AI search data: you can set the time period of keep the data. When the set time is reached, the data is automatically cleared.</p> <p>Export Whiteboard AI search data: With Whiteboard AI Search enabled, click the export option to download the search data as a spreadsheet.</p>
Enable embedded OS	<p>Once you disable the embedded OS, IFPD will access the no android mode, android system will not appear, Android USB ports are disabled, only the Public USB port is retained, and gestures are not allowed to bring up the Android menu.</p> <p>You can enter the quick setting by the following ways:</p> <ol style="list-style-type: none"> <li>1 Press the <b>MENU</b> button on the front panel to enter the quick setting;</li> <li>2 Slide up with two finger to callout the quick setting.</li> </ol> <p>How to exit the no android mode:</p> <ol style="list-style-type: none"> <li>1 Press the <b>Down &gt; Down &gt; Up &gt; Up &gt; Left &gt; Right</b> on the remote control.</li> <li>2 Press the <b>Up &gt; Down &gt; Up &gt; Down&gt; Left &gt; Right &gt; Left &gt; Right &gt; Volume + &gt;Volume –</b> on the remote control to enter the <b>Advanced</b> menu, enable the <b>Enable Embedded OS</b> function.</li> </ol>
Modify admin mode password	You can modify admin mode password in this interface. The password must be between 6 to 16 digits or letters.
Maximum volume	The maximum volume was set at 10% increments.
User permission customization	Tap to set custom user permissions.
Handwriting response	The default value is 50 points, customizable by the user with a minimum of 20 points, and this setting only applies to Android.

### 4.6.3 Connected devices

Enter the **Connected devices** submenu to check the connected devices, system will automatically detect and connect to new device via Bluetooth.

Menu	Functions
Pair new device	Turn on Bluetooth and automatically search for available devices nearby. 1 Pairing other display, mobile phones, computers, need to enter the pairing password or two-way confirmation; 2 Bluetooth audio, keyboard and mouse can be directly paired, no need to enter a password.
See all	All devices can be viewed, including paired and available devices.
Connection preference	It can be set to print/cast/quick share through Bluetooth, and Cross-device services via your Google Account.

### 4.6.4 Apps

Enter the **Apps** submenu to view downloaded applications, screen time, unused apps and Special app access.

Menu	Functions
All apps	Display the installed app, you can enter a single app to set application information, such as: open notification, view memory and mobile data and other information.
Default apps	Display default apps
Screen time	Display the usage time of each app
Unused apps	Display unused apps
Special app access	App access

### 4.6.5 Notifications

Enter the **Notifications** submenu to manage the notifications about apps, view the notification history, set the notifications about conversations and etc.

<b>Menu</b>	<b>Functions</b>
App notifications	Sets whether app notifications are turned on.
Notification history	Display notification history
Conversations	Priority and modified conversations will appear here.
Bubbles	Some conversations will appear as floating icons on the top of other apps.
Notification read, reply & control	Set which apps or devices can read notifications.
Notifications on lock screen	Set how to display notifications on the lock screen page.
Do not disturb	Tap to enable Do Not Disturb mode.
Notification cooldown	When you receive many notifications within a short time, your device will lower its volume and minimize alerts for up to 1 minute. Calls, alarms, and priority conversations are not affected.
Flash notifications	Flash the screen when you receive notifications or when alarms sound.
Wireless emergency alerts	Switch ON/OFF
Hide silent notifications in status bar	Switch ON/OFF
Allow notification snoozing	Switch ON/OFF
Notification dot on app icon	Switch ON/OFF
Enhanced notifications	Switch ON/OFF

## 4.6.6 Storage

Enter the **Storage** submenu to view the storage and space distribution of the device and disk.

Menu	Functions
This device	Displays the memory for the display
USB	Displays the memory of the external USB
SD card	Displays the memory of the SD card

## 4.6.7 Sound and vibration

Enter the **Sounds and vibration** submenu to adjust the sound of media volume, call volume, alarm volume and notification volume.

Default notification sound, Default alarm sound, Screen lock sound and Touch sounds also can be set on the interface.

Menu	Functions
Media volume	Adjust the volume of media.
Do not disturb	Turn Do not Disturb mode on or off, set the apps available in Do not disturb mode.
Live Caption	Live Caption detects speech on your device and automatically generates captions.
Default Notification sound	Set the default Notification sound.
Default alarm sound	Set the default alarm sound.
Screen locking sound	Switch ON/OFF
Tap & click sounds	Switch ON/OFF

## 4.6.8 Display

Enter the **Display** submenu to set the Brightness, Lock screen, screen timeout, Dark theme, display size and text, Theme, logo, Set logo, Colours, Screen saver.

Menu	Setting	Functions
Brightness	Brightness level	Adjust brightness level
	Adaptive brightness	Switch on/off. After opening, the screen is adjusted to the eye protection state according to the light perception.
Lock display	Lock screen	Set the operation information of the lock screen page.
	Screen timeout	Set the screen saver time, the screen will lock automatically after reaching the set time.
Appearance	Dark theme	Switch on/off, default off.
	Display size and text	Set font size and screen size.
Color	Colors	Set the color.
	Color Contrast	Set the Color Contrast.
Other display controls	Screen saver	Switch on/off.
	HDMI	When an external device is connected to HDMI Out or Type-C Out, display resolution and screen zoom settings become available.

## 4.6.9 Wallpaper & Style

Enter the **Wallpaper** submenu to add the wallpaper from file viewer and photos, set the color and size for lock screen and Home screen.

## 4.6.10 Accessibility

Enter the **Accessibility** submenu to enable the talkback, select to speak, live caption, accessibility menu and etc.

Menu	Functions
Talkback	Enable the talkback and talkback shortcut.
Select to speak	Switch on/off
Display size and text	Set the font size and display size.
Color and motion	Enable and disable the Color inversion, Dark theme, Color correction, Remove animations.
Magnification	Set the Magnification shortcut and Magnification type.
Accessibility Menu	Enable the Accessibility Menu shortcut.
Switch Access	Use the switch access, enable and disable switch access shortcut.
Timing controls	Set the touch & hold delay and time to take action.
System controls	Set the navigation mode.
Live caption	Enable the live caption and set the languages and preferences.
Caption preferences	Set to show captions, customize caption size and style.
Audio description	Switch on/off
Flash notifications	Enable the screen flash and set the screen flash color.
Hearing devices	Pair hearing aids, enable the hearing device shortcut.
Audio adjustment	Enable the mono audio and adjust the audio balance.
Accessibility shortcuts	Set the Accessibility button, enable the volume keys shortcut from lock screen.
Text-to-speech output	Set the Preferred engine, language, speech rate and pitch.

## 4.6.11 Security & privacy

Enter the **Security** submenu to view the security status, find my device, update the security and add the screen lock.

Menu	Functions
Scan device	Scans the device for potential risks.
Google Play protect	Check the apps and device for harmful behavior.
Screen lock	None: Turn off the screen lock.
	Swipe: Swipe the screen to unlock.
	Pattern: Draw an unlock pattern, the pattern need connect at least 4 dots.
	PIN: Set the pin code, the pin must be at least 4 digits.
	Password: Set the password, the password must be at least 4 characters.
Account security	Google Account Security.
Find my device	Log into your google account and follow the prompts to find your missing device.
System & updates	Check for update.
Privacy controls	Privacy controls to manage permissions and protect personal data safely.
Privacy dashboard	View apps that recently used permissions.
Privacy space	Privacy Space stores private apps and data with independent encryption to protect your privacy.
More security & privacy	Set the smart lock, view and install the encryption and credentials.

## 4.6.12 Location

Enter the **Location** submenu to use location, view the apps recently accessed location and location services.

Menu	Functions
Use location	Switch ON/OFF
App location permissions	Set the permission of app to access the device's location.
Location services	Enable Location Accuracy for precise location.

### 4.6.13 Passwords, Passkeys & Account

Enter the **Passwords, passkey & accounts** submenu to add your preferred services, sign in and auto Automatically sync app data.

### 4.6.14 Google

Enter the **Google** submenu to sign in to your google account, set the account related services, including backup data, find hub, etc.

You can sign in to your google account by the following method:

- On the Home page, slide right to enter the google login interface;
- Sign in to any one of google apps;
- Enter **Settings > Google** to sign in.

### 4.6.15 System

Enter the **System** submenu to see system version information and admin mode.

Menu	Setting	Functions
Languages	Set the language	System language, app language, regional preference, speech.
Keyboard	Select the keyboard	On-screen keyboard and physical keyboard are available for selection, along with access to tools such as spell checker, personal dictionary, and pointer speed adjustment.
Gesture	Navigation mode	Gesture navigation, 3-button navigation can be chosen.
Date & Time	Set time automatically	Switch ON/OFF Networking to get time and date automatically.
	Date	When the Set time automatically is off, tap to set the date.
	Time	When the Set time automatically is off, tap to set the time.
	Set time zone automatically	Switch ON/OFF Networking to get time zone automatically.
	Set NTP server	Tap to select the NTP Server. NTP synchronizes the device time with network time servers.
	Time zone	When the Set time zone automatically is off, tap to select the time zone.
	Use locale default	Switch ON/OFF
	Use 24-hour format	Switch ON/OFF

Menu	Setting	Functions
System update	Check for updates	Check for updates to upgrade Android version.
Multiple users	Allow multiple users	<p>Enable the function to share your tablet by adding new users. Each user has a personal space on your tablet.</p> <p>The icon  will appear on the lock screen page and quick setting menu when the function is enabled.</p>
	Owner	<p>Profile info: Tap to change owner icon and name.</p> <p>Owner import: If you had more than two devices and would like to keep the setting as the same. You can put the export file into the USB disk and plug it into the USB port, then press the import option to import the setting you have done in the other device.</p> <p>Owner export: If you had more than two devices and would like to keep the setting as the same. You can export the settings in the setting page.</p>
	User	<p>Delete user: Tap to delete user apps and data.</p> <p>User import: If you had more than two devices and would like to keep the setting as the same. You can put the export file into the USB disk and plug it into the USB port, then press the import option to import the setting you have done in the other device.</p> <p>User export: If you had more than two devices and would like to keep the setting as the same. You can export the settings in the setting page.</p> <p>Profile info: Tap to change owner icon and name.</p>
	Guest	<p>Remove guest: Tap to remove guest apps and data.</p> <p>Exit guest mode: All activity will be deleted on exit.</p> <p>Reset guest session: Start a new guest session and delete all apps and data from the current session.</p>

Menu	Setting	Functions
Multiple users	Add User	<p>You can share this device with other people by creating additional users. Each user has their own space with customizable options such as apps, wallpapers and so on.</p> <p>Switch to new user: Tap to switch to other user or guest.</p> <p>Delete user: Delete the user account.</p> <p>User import: If you would like to keep the setting as the same. You can put the export file into USB disk and plug it into USB port, then press the import option to import the setting you have done in the other device. You can also import or export the settings of the same device. The settings of different users can be exported to each other.</p> <p>User export: If you would like to keep the setting as the same. You can export the settings on the setting page.</p>
	Add Guest	No password is required to access the system as a guest.
	Delete guest activity	Switch on/off
	Add users from lock screen	Switch on/off
Reset options	Reset Bluetooth & Wi-Fi	Tap to reset all network settings.
	Reset App Preferences	Tap to reset all preferences.
	Delete private space	Tap to delete private space.
	Erase all data (factory reset)	Tap to erase all data.



### Multiple Users Accounts

There are multiple user roles on the system, and the permissions for each role can be assigned as shown in the table below.



Functions	Admin	Owner	User	Guest
Capacity	1	1	No quantity limit	1
Password composition	≤16 digits	4 digits	4 digits	None
Enter advanced menu	2364606633	2364606633	No permission	No permission

### How to create multiple users

The multiple users icon  will appear on the lock screen page and quick setting menu when the multiple users function is enabled, tap the icon to add roles and switch users. You can create account by the following method:

- Enter **Settings > System > Multiple users** to add users;
- Tap the  icon on the lock screen page to add users;
- Tap the  icon on the quick setting menu to add users.

### How to switch accounts between multiple users

- Enter **Settings > System > Multiple users> switch to new user**;
- Tap the  icon on the lock screen page to switch users.
- Tap the  icon on the quick setting menu to switch users.

## 4.6.16 About Tablet

Enter the **About tablet** submenu to check the system info such as Model, serial number, system version, firmware version, IP address, MAC address...etc.

Menu	Functions
Device name	Display device name
Legal information	Display legal information
Model	Display device model
RAM	Display the RAM of the device
Serial number	Display Serial number
Android version	Display Android version
Firmware version	Display Firmware version

Menu	Functions
IP address	Display IP address
Wi-Fi MAC address	Display Wi-Fi Mac address
Mac address	Display Mac address
Bluetooth address	Display Bluetooth address
Up time	Display the up time
Screen time	Tap to set the type of screen time, options included total screen time, daily screen time and weekly screen time.
Build number	Display build number

# 5

## Serial Port Control

RS232 communication cable (please use cross data cables)

PIN	This Device	Computer
1	NC	NC
2	RXD0	TXD0
3	TXD0	RXD0
4	NC	NC
5	GND	GND
6	NC	NC
7	NC	NC
8	NC	NC
9	NC	NC
Cover	GND	GND

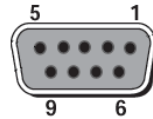

RS232 port of panel

Connect RS-232 port to the PC or controlling product. Enable RS-232 serial port connection and complete the following configuration.

Port: COM1 (Set according to PC or controlling product's port number)			
Baud rate	19200	Odd/even check	None
Data bits	8	Stop bit	1

• The following tables list controlling codes, querying codes and return codes.

Function	Controlling codes	Return codes
Power on	7F 08 99 A2 B3 C4 02 FF 01 00 CF	7F 09 99 A2 B3 C4 02 FF 01 00 01 CF
Power off	7F 08 99 A2 B3 C4 02 FF 01 01 CF	7F 09 99 A2 B3 C4 02 FF 01 01 01 CF
Mute/Unmute	7F 08 99 A2 B3 C4 02 FF 01 02 CF	7F 09 99 A2 B3 C4 02 FF 01 02 01 CF
Signal source	7F 08 99 A2 B3 C4 02 FF 01 06 CF	7F 09 99 A2 B3 C4 02 FF 01 06 01 CF

Function	Controlling codes	Return codes
Enable whiteboard	7F 08 99 A2 B3 C4 02 FF 01 07 CF	7F 09 99 A2 B3 C4 02 FF 01 07 01 CF
Display status	7F 08 99 A2 B3 C4 02 FF 01 09 CF	7F 09 99 A2 B3 C4 02 FF 01 09 01 CF
HDMI front / HDMI 1	7F 08 99 A2 B3 C4 02 FF 01 0A CF	7F 09 99 A2 B3 C4 02 FF 01 0A 01 CF
HDMI rear 1 / HDMI 2	7F 08 99 A2 B3 C4 02 FF 01 52 CF	7F 09 99 A2 B3 C4 02 FF 01 52 01 CF
HDMI rear 2 / HDMI 3	7F 08 99 A2 B3 C4 02 FF 01 53 CF	7F 09 99 A2 B3 C4 02 FF 01 53 01 CF
VGA / USB-C (Front)	7F 08 99 A2 B3 C4 02 FF 01 54 CF	7F 09 99 A2 B3 C4 02 FF 01 54 01 CF
USB-C (Rear)	7F 08 99 A2 B3 C4 02 FF 01 55 CF	7F 09 99 A2 B3 C4 02 FF 01 55 01 CF
Internal PC	7F 08 99 A2 B3 C4 02 FF 01 38 CF	7F 09 99 A2 B3 C4 02 FF 01 38 01 CF
Internal SDM	7F 08 99 A2 B3 C4 02 FF 01 39 CF	7F 09 99 A2 B3 C4 02 FF 01 39 01 CF
DP	7F 08 99 A2 B3 C4 02 FF 01 56 CF	7F 09 99 A2 B3 C4 02 FF 01 56 01 CF
Page up	7F 08 99 A2 B3 C4 02 FF 01 13 CF	7F 09 99 A2 B3 C4 02 FF 01 13 01 CF
Page down	7F 08 99 A2 B3 C4 02 FF 01 14 CF	7F 09 99 A2 B3 C4 02 FF 01 14 01 CF
VOL -	7F 08 99 A2 B3 C4 02 FF 01 17 CF	7F 09 99 A2 B3 C4 02 FF 01 17 01 CF
VOL +	7F 08 99 A2 B3 C4 02 FF 01 18 CF	7F 09 99 A2 B3 C4 02 FF 01 18 01 CF
Menu	7F 08 99 A2 B3 C4 02 FF 01 1B CF	7F 09 99 A2 B3 C4 02 FF 01 1B 01 CF
Home page	7F 08 99 A2 B3 C4 02 FF 01 1C CF	7F 09 99 A2 B3 C4 02 FF 01 1C 01 CF
Return (exit)	7F 08 99 A2 B3 C4 02 FF 01 1D CF	7F 09 99 A2 B3 C4 02 FF 01 1D 01 CF
OK	7F 08 99 A2 B3 C4 02 FF 01 2B CF	7F 09 99 A2 B3 C4 02 FF 01 2B 01 CF
←	7F 08 99 A2 B3 C4 02 FF 01 2C CF	7F 09 99 A2 B3 C4 02 FF 01 2C 01 CF
→	7F 08 99 A2 B3 C4 02 FF 01 2D CF	7F 09 99 A2 B3 C4 02 FF 01 2D 01 CF

Function	Controlling codes	Return codes
↑	7F 08 99 A2 B3 C4 02 FF 01 2E CF	7F 09 99 A2 B3 C4 02 FF 01 2E 01 CF
↓	7F 08 99 A2 B3 C4 02 FF 01 2F CF	7F 09 99 A2 B3 C4 02 FF 01 2F 01 CF
Set volume	7F 08 99 A2 B3 C4 02 FF 05 XX CF NOTE: XX indicates the value of volume (0- 100), corresponding to the hexadecimal number system (00 - 64).	7F 09 99 A2 B3 C4 02 FF 05 XX 01 CF
Query the firmware version number	7F 08 99 A2 B3 C4 02 FF 01 3D CF	7F 09 99 A2 B3 C4 02 FF 01 3D XX CF Note: XX indicates version (20211110183518)
Set display mode	7F 08 99 A2 B3 C4 02 FF 06 XX CF NOTE: XX indicates the mode. 00-standard, 01-ECO mode, 02-custom,03-auto	7F 09 99 A2 B3 C4 02 FF 01 40 01 CF
Enable the annotation function	7F 08 99 A2 B3 C4 02 FF 01 40 CF	7F 09 99 A2 B3 C4 02 FF 01 40 01 CF
Increase backlight brightness	7F 08 99 A2 B3 C4 02 FF 01 47 CF	7F 09 99 A2 B3 C4 02 FF 01 47 01 CF
Decrease backlight brightness	7F 08 99 A2 B3 C4 02 FF 01 48 CF	7F 09 99 A2 B3 C4 02 FF 01 48 01 CF
Set the value of backlight brightness	7F 08 99 A2 B3 C4 02 FF 09 XX CF NOTE: XX indicates the value of backlight brightness (1- 100), corresponding to the hexadecimal number system (01- 64).	7F 09 99 A2 B3 C4 02 FF 09 XX 01 CF
Switch backlight	7F 08 99 A2 B3 C4 02 FF 01 15 CF	7F 09 99 A2 B3 C4 02 FF 01 15 XX CF NOTE: ● XX = 01 indicates the backlight is on. ● XX = 00 indicates the backlight is off.

Function	Controlling codes	Return codes
Switch to screen lock	7F 08 99 A2 B3 C4 02 FF 01 57 CF	7F 09 99 A2 B3 C4 02 FF 01 57 01 CF
Screenshot	7F 08 99 A2 B3 C4 02 FF 01 1F CF	7F 09 99 A2 B3 C4 02 FF 01 1F 01 CF
Settings	7F 08 99 A2 B3 C4 02 FF 01 20 CF	7F 09 99 A2 B3 C4 02 FF 01 20 01 CF
Freeze ON/OFF toggle	7F 08 99 A2 B3 C4 02 FF 01 3B CF	7F 09 99 A2 B3 C4 02 FF 01 3B 01 CF
Freeze On	7F 09 99 A2 B3 C4 02 FF 0B 00 CF	7F 09 99 A2 B3 C4 02 FF 0B 00 01 CF
Freeze Off	7F 09 99 A2 B3 C4 02 FF 0B 01 CF	7F 09 99 A2 B3 C4 02 FF 0B 01 01 CF
Mute On	7F 09 99 A2 B3 C4 02 FF 0F 00 CF	7F 09 99 A2 B3 C4 02 FF 0F 00 01 CF
Mute Off	7F 09 99 A2 B3 C4 02 FF 0F 01 CF	7F 09 99 A2 B3 C4 02 FF 0F 01 01 CF
Switch Safety Lock On	7F 09 99 A2 B3 C4 02 FF 0D 01 CF	7F 09 99 A2 B3 C4 02 FF 0D 01 01 CF
Switch Safety Lock Off	7F 09 99 A2 B3 C4 02 FF 0D 00 CF	7F 09 99 A2 B3 C4 02 FF 0D 00 01 CF
Switch Backlight On	7F 09 99 A2 B3 C4 02 FF 0E 01 CF	7F 09 99 A2 B3 C4 02 FF 0E 01 01 CF
Switch Backlight Off	7F 09 99 A2 B3 C4 02 FF 0E 00 CF	7F 09 99 A2 B3 C4 02 FF 0E 00 01 CF
Set Display message on the OSD	7F 09 99 A2 B3 C4 02 FF 1A XX CF NOTE: ● XX indicates the value of text content up to 50 characters	7F 09 99 A2 B3 C4 02 FF 1A 00 XX CF NOTE: ● XX = 01 indicates set OSD OK. ● XX = 00 indicates set OSD failed.
Cancel display message on the OSD	7F 09 99 A2 B3 C4 02 FF 1B 00 CF	7F 09 99 A2 B3 C4 02 FF 1A 01 XX CF NOTE: ● XX = 01 indicates set OSD OK. ● XX = 00 indicates set OSD failed.

Function	Controlling codes	Return codes
Activate Newline cast	7F 08 99 A2 B3 C4 02 FF 00 0D CF	7F 09 99 A2 B3 C4 02 FF 00 0D 01 CF
Close Newline cast	7F 08 99 A2 B3 C4 02 FF 01 0D CF	7F 09 99 A2 B3 C4 02 FF 01 0D 01 CF
Activate Newline Signage Pro	7F 08 99 A2 B3 C4 02 FF 00 B1 CF	7F 08 99 A2 B3 C4 02 FF 00 B1 01 CF
Close Newline Signage Pro	7F 08 99 A2 B3 C4 02 FF 00 B2 CF	7F 08 99 A2 B3 C4 02 FF 00 B2 01 CF

Function	Querying codes	Return codes
Power supply	7F 08 99 A2 B3 C4 02 FF 01 37 CF	7F 09 99 A2 B3 C4 02 FF 01 37 XX CF <ul style="list-style-type: none"> <li>● XX indicates the power on/off state.</li> <li>● XX = 01: power on state</li> <li>● XX = 00: power off state</li> </ul>
Speaker	7F 08 99 A2 B3 C4 02 FF 01 82 CF	7F 09 99 A2 B3 C4 02 FF 01 82 XX CF <ul style="list-style-type: none"> <li>● 01: mute</li> <li>● 00: non-mute</li> </ul>
Current signal source	7F 08 99 A2 B3 C4 02 FF 01 50 CF	7F 09 99 A2 B3 C4 02 FF 01 50 XX CF <ul style="list-style-type: none"> <li>● Smart system = 30</li> <li>● PC = 17</li> <li>● SDM = 18</li> <li>● DP = 20</li> <li>● HDMI Front (1) = 19</li> <li>● HDMI Rear 1 (2) = 1F</li> <li>● HDMI Rear 2 (3) = 1E</li> <li>● VGA/USB-C Front = 00</li> <li>● USB-C Rear = 01</li> </ul>

Function	Querying codes	Return codes
Speaker volume	7F 08 99 A2 B3 C4 02 FF 01 33 CF	7F 09 99 A2 B3 C4 02 FF 01 33 XX CF XX indicates current volume value (XX is a hexadecimal value, range: 00~64). For example, XX = 20 indicates current volume value is 32 (decimal value), XX = 00 indicates mute state.
D.Mode	7F 08 99 A2 B3 C4 02 FF 01 35 CF	7F 09 99 A2 B3 C4 02 FF 01 35 XX CF XX indicates the mode. 00-standard, 01-ECO mode, 02-custom, 03-auto
Backlight brightness	7F 08 99 A2 B3 C4 02 FF 01 49 CF	7F 09 99 A2 B3 C4 02 FF 01 49 XX CF XX indicates the value of backlight brightness (1 - 100), corresponding to the hexadecimal number system (01 - 64).
Backlight status	7F 08 99 A2 B3 C4 02 FF 01 81 CF	7F 09 99 A2 B3 C4 02 FF 01 81 XX CF <ul style="list-style-type: none"> <li>● XX = 00 indicates the backlight is on.</li> <li>● XX = 01 indicates the backlight is off.</li> </ul>
Power button lock status	7F 08 99 A2 B3 C4 02 FF 01 84 CF	7F 09 99 A2 B3 C4 02 FF 01 84 XX CF <ul style="list-style-type: none"> <li>● XX = 01 indicates the power button lock is on.</li> <li>● XX = 00 indicates the power button lock is off.</li> </ul>
Whiteboard state	7F 08 99 A2 B3 C4 02 FF 01 83 CF	7F 09 99 A2 B3 C4 02 FF 01 83 XX CF <ul style="list-style-type: none"> <li>● XX = 01 indicates the whiteboard state.</li> <li>● XX = 00 indicates non-whiteboard state.</li> </ul>
Return to system state of the previous options	7F 08 99 A2 B3 C4 02 FF 0A 00 CF	7F 08 99 A2 B3 C4 02 FF 0A 00 AB CD EF GH IJ OP QR ST UV CF <ul style="list-style-type: none"> <li>● AB: Power supply</li> <li>● CD: Speaker</li> <li>● EF: Current signal source</li> <li>● GH: Speaker volume</li> <li>● IJ: D.Mode</li> <li>● OP: backlight brightness</li> <li>● QR: backlight state</li> <li>● ST: Whiteboard state</li> <li>● UV: Screen lock state</li> </ul>

# 6

## FAQs & Troubleshooting

Symptom	Troubleshooting Methods
The screen cannot be powered on or the power indicator light is off.	<ul style="list-style-type: none"> <li>• Check whether the power supply is connected.</li> <li>• Check whether the power supply plug is properly connected.</li> <li>• Check whether the power outlet has electricity.</li> <li>• Check whether the rocker switch is enabled.</li> <li>• Press the reset switch and start the system again.</li> </ul>
The remote control is not causing a response.	<ul style="list-style-type: none"> <li>• Replace the batteries.</li> <li>• Check whether the polarity direction of the batteries is correct.</li> <li>• Align the remote control with the IR receiver window. For details, see section "Remote Control".</li> </ul>
The image is normal but there is no sound.	<ul style="list-style-type: none"> <li>• Increase volume on both the screen and the Windows system.</li> <li>• Check whether the screen and the Windows system are muted.</li> <li>• If an external computer is connected, check whether the connection cables are normal.</li> </ul>
The system is automatically powered on/off when no operation is being performed.	<ul style="list-style-type: none"> <li>• Disable the automatic power-on/off function. For details, see section "Power ON/OFF Setting".</li> <li>• Check whether the screen entered shut down mode due to no operation for an extended period of time.</li> <li>• Check whether the input power supply is stable.</li> </ul>
The colors of images are abnormal.	Check whether the HDMI cable is properly connected or has any quality issue.
The touch function is abnormal or the positioning is inaccurate.	<ul style="list-style-type: none"> <li>• Restart the screen.</li> <li>• In the Windows system, recalibrate the screen. For details, see section "Calibration".</li> </ul>
The touch function is unavailable when the external signal source channel is being used.	<ul style="list-style-type: none"> <li>• Switch between different external signal sources.</li> <li>• Ensure that the USB touch cable is connected to the proper port. For details, see section "Ports".</li> <li>• Remove and insert the USB touch cable again.</li> </ul>
There is no sound when the HDMI in channel is used.	Remove and insert the HDMI cable again.

Symptom	Troubleshooting Methods
No image is displayed when the HDMI out channel is used.	<ul style="list-style-type: none"> <li>• Generally, this issue is caused by the compatibility of the external display product. Replace the external display product and test again.</li> <li>• The HDMI cable is too long or has a poor quality. Replace the HDMI cable delivered with the product.</li> </ul>
The touch function on the front panel is ineffective.	<ul style="list-style-type: none"> <li>• Touch the button using your full fingertip.</li> <li>• Check whether the finger is wet or has other liquids on it.</li> <li>• Restart the screen.</li> </ul>
The USB flash drive cannot be identified.	Check whether the USB flash drive is inserted into the correct USB port. For details, see section "Ports."
The conference records cannot be saved on the USB flash drive, and the system prompts "The target storage product has no write permissions."	Format the USB flash drive to the FAT32 format.
The OPS has no signal.	<ul style="list-style-type: none"> <li>• Check whether the OPS is properly inserted in the slot.</li> <li>• Check whether the OPS is in shut down mode.</li> <li>• Press the power button on the OPS (for details, see the instructions of the OPS), and manually start up the OPS.</li> </ul>
In the embedded operating system or Windows system, no wireless network can be found or the wireless network signal is weak.	Check whether the Wi-Fi antenna is properly installed on the embedded operating system. For details, see section "Ports".
	Check whether the Wi-Fi antenna is properly installed for the OPS.

# 7

## Specifications

Model	TT-5526QULT	TT-6526QULT	TT-7526QULT	TT-8626QULT	TT-9826QULT
<b>Display</b>					
Backlight	LED				
Active Screen Size	55 inch	65 inch	75 inch	86 inch	98 inch
Display Ratio	16:9				
Resolution	3840 x 2160 Pixel				
Refresh Rate	60 Hz				
Display Colors	8bit+FRC, 1.07 billion colors				
After Glass Center Brightness (Typ.)	≥ 550 cd/m <sup>2</sup>				
Response Time	≤8 ms				
Hardware blue light filter	Yes				
Viewing Angle	178°				
Display Life Time	≥50000 h (Min.)				
<b>Speaker</b>					
Speaker Position	Bottom Front				
Max. Power Output	2 x 20 W				

Model	TT-5526QULT	TT-6526QULT	TT-7526QULT	TT-8626QULT	TT-9826QULT
<b>Electrical</b>					
Power Consumption	Maximum ≤ 550 W Standby Mode ≤ 0.5 W	Maximum ≤ 600 W Standby Mode ≤ 0.5 W	Maximum ≤ 600 W Standby Mode ≤ 0.5 W	Maximum ≤ 750W Standby Mode ≤ 0.5 W	Maximum ≤ 850 W Standby Mode ≤ 0.5 W
Working Voltage	AC 100 V – 240 V, 50 Hz / 60 Hz				
Extra power delivery supply	180W				
<b>Touch</b>					
Touch Surface	Anti-Glare + Anti-Fingerprint + Antimicrobial Tempered Glass				
Glass Hardness	9H(Pencil)				
Glass Haze	15-25%				
Touch Solution	IR				
Touch Points	Android 50 points, Windows 50 points				
Writing Tools	Eraser, Stylus or Finger				
Communication Interface	USB				
<b>Transportation/Storage</b>					
Storage Temperature/ Humidity	-20~60°C /0~90%RH (non-condensing)				

Model	TT-5526QULT	TT-6526QULT	TT-7526QULT	TT-8626QULT	TT-9826QULT
Working Temperature/ Humidity	0°C-40°C /20°C~80°C RH(Non coagulation)				
Installation Method (optional)	Wall-mounted/Mobile Stand				
Outline Dimension (without wall mount bracket)	1280*109*799mm	1487*121*909mm	1709*122*1033mm	1955*122*1171mm	2237*120*1345mm
Packing Dimension	1414 x 185 x 915mm	1634 x 185 x 1015 mm	1844 x 207 x 1145 mm	2094 x 227 x 1280 mm	2385 x 285 x 1593 mm
Net Weight	28kg /61.7lb	33.5kg /73.9lb	44.5kg /98.11lb	59.5kg /131.17lb.	105kg /231.49lb
Gross Weight	35.5kg/78.3lb	42kg/93lb	56.5kg/124.6lb	71.5kg/ 157.6lb	125.5kg/ 276.7lb
<b>Ports</b>					
Front Interface Inputs	HDMI In x 1, USB (Touch) x 1, USB 3.0 x 2, Microphone In x 1, Type C (PD 65W) x 1				
Rear Interface Inputs	RS232 x 1, Line Out x 1, SPDIF Out x 1, HDMI Out x 1, Android USB 3.0 x 1, LAN IN x 1, LAN OUT x 1, Battery x 1, Mic in x 1, Type C out x 1 DP x 1, USB3.0 (Touch) x 3, USB 3.0 (Public) x 2, Type C (PD 15W) x 1,HDMI In 2 (ARC) x 1, HDMI In 3 x 1, OPS Slots (4K@60Hz)				
<b>Other functions</b>					
Intelligent thermos protector	Yes				
<b>Smart System</b>					
RAM	16G				
ROM	128GB				
Androi Version	Android 16				

Model	TT-5526QULT	TT-6526QULT	TT-7526QULT	TT-8626QULT	TT-9826QULT
OS Version	EDLA				
Pre-installed applications	Refer to the actual panel display				
Firmware Version	V1.1.31				
<b>Wi-Fi Module</b>					
WiFi Module Model	Built-in				
WiFi Version	Wi-Fi 6 +Wi-Fi5				
Bluetooth Version	BT 5.2				

# **HDMI™**

The Adopted Trademarks HDMI, HDMI High-Definition Multimedia Interface, HDMI trade dress and the HDMI Logos are trademarks or registered trademarks of HDMI Licensing Administrator, Inc. in the United States and other countries." OR "The terms HDMI, HDMI High-Definition Multimedia Interface, HDMI trade dress and the HDMI Logos are trademarks or registered trademarks of HDMI licensing Administrator, inc.

# 8

## More Information

---

### **For more information**

Please visit our website ([www.newline-interactive.com](http://www.newline-interactive.com)) for detailed instruction manual.

### **Contact Us for Support**

Please email us at [support@newline-interactive.com](mailto:support@newline-interactive.com).

Our company is devoted to product innovation and technology enhancement. Therefore, we may change product specification and information without notice. Product pictures in the manual are for reference only, please refer to actual products.